

USER MANUAL FOR BEAMEX MC6 ADVANCED FIELD CALIBRATOR AND COMMUNICATOR

Applies to firmware version 3.10

Dear user,

We have made every effort to ensure the accuracy of the contents of this manual. Should any errors be detected, we would greatly appreciate to receive suggestions to improve the quality of the contents of this manual.

For more detailed technical data about Beamex MC6 Advanced Field Calibrator and Communicator, please contact the manufacturer.



© Beamex 2012 - 2018

BEAMEX OY AB

Ristisuonraitti 10

FIN-68600 Pietarsaari

FINLAND

Tel +358 - 10 - 5505000

Fax +358 - 10 - 5505404

E-mail: sales@beamex.com

service@beamex.com

Internet: <https://www.beamex.com>

CONTENTS

Part 1, Introduction

General	2
About This Manual.....	2
Where Am I?.....	2
Typographical Conventions	3
Unpacking and Inspection	3
About MC6	4
Starting MC6	4
Firmware	5
Hardware.....	7
General.....	7
Connectors on Top of MC6.....	8
Connectors on the Right Side of MC6.....	8
Internal Barometric Pressure Module.....	9
Memory	9
Display.....	9
Batteries	10
PC Communication / Calibration Software	12
USB Communication Driver	12
MC6 Related Tools Available for PC.....	12
Options	13
Software Options.....	13
Hardware Modules/Options and Accessories	14
Related Products	14

Part 2, Active Terminals and Connections

General	16
Measurements	17
Pressure Measurement.....	17
Connecting and Disconnecting External Pressure	
Modules	17
Zeroing a Pressure Module	17
Current Measurement	18
Voltage Measurement.....	18
Temperature Measurement (Thermocouple).....	19
Temperature Measurement (RTD)	19
Resistance Measurement	20
Frequency Measurement	20
Pulse Counting.....	21
Switch Sensing	21
Generations/Simulations	22
Changing the Generated/Simulated Value	22
Using the Soft Numeric Keypad	22
Spinning.....	23
Current Generation (Source or Sink).....	24
Voltage Generation	24
Thermocouple Simulation	25
RTD Sensor Simulation.....	25
Resistance Simulation.....	26
Frequency Generation	26
Pulse Generation	27
Thermocouple Connections	28

Part 3, Meter

About Meter	30
--------------------	-----------

Part 4, Calibrator

About Calibrator	32
Tools	33
General	33

Part 5, Documenting Calibrator

General	36
Calibration Software	36
Calibrating Instruments	37
Generating/Simulating the Input Value	37
Instrument List	38
Instruments	38
Instrument List Window Menu	39
Plant Structure Levels	39
Work Order View Mode	40
Instrument Overview Window	41
Calibrating an Instrument Using MC6	41
Changing the Pressure Module During Calibration	43
About Fieldbus and HART Device Specifics	44
Group Calibration	45
Collecting Instruments/Functions for Group Calibration	45
Editing a Group	46
Calibrating a Group	46
Group Settings	47
Performing the Calibration	47
Calibration Results	48
Deleting Calibration Results	48
Digital Communication and MC6's Instrument Data	49
Getting and Editing Mapped Data	49
Preparations	49
Getting Default Mappings	50
Customizing the Mappings	50

Part 6, Data Logger

General	54
Doing a Data Log	55
Configuring	55
Saving and Opening Configurations	55
Starting the Data Log	56
Viewing and Saving or Deleting the Results	57
Viewing Saved Data Log Results	57
Transferring Data Log Results to a Personal Computer	58

Part 7, Communicator

General	60
Warnings	61
Connections	62
Selecting the Instrument	63
List of Found Devices	63
About Instrument Parameters	64
Instrument Parameters in General	64
Calibrating or Data Logging HART instruments	65
Calibrating or Data Logging Fieldbus Instruments	65
Editing Parameters	66
Trimming a Fieldbus instrument	67
Trimming a HART instrument	68
HART Device Description Specifics	69
General	69
Basic View	70

Managing Smart Transmitter Configurations	71
General	71
Tools in MC6	71
Saving Configurations.....	71
Viewing/Managing Configurations.....	72
Beamex MC6 Fieldbus Configuration Viewer.....	72
Uploading Configurations.....	72
Linking Configurations to CMX.....	72

Part 8, Settings

Settings	74
Optional Security Tool	75
General	75
Applied Restrictions	75
Supervisor Window.....	76

Part 9, Additional Information

Additional Information	78
User Defined Pressure Units	79
User Defined PRT / RTD Sensors	80
General.....	80
Callendar van Dusen Formula for PRTs	81
ITS-90 PRT Sensor	81
Factor	83
Check Sensor Conversion	83
User Defined Transfer Functions	84
User Defined Steps / Calibration Points.....	85
Controller Communication	86
What Can be Done With Controller Communication.....	86
Configuring Controller Communication	87
Changing Controller During Calibration.....	87

Appendix

Safety	90
Approvals.....	90
Symbols Used.....	90
Safety Precautions and Warnings	91
Operating Conditions	91
General Warnings	91
Warnings Concerning the Lithium Polymer Battery Pack.....	92
Warnings Concerning Electrical Measurement and Generation	94
General Warnings Concerning Pressure Measurement	94
Warnings Concerning High Pressure	95
Disposal of Waste Electrical and Electronic Equipment	96
Beamex and WEEE	96
Disposal of Battery Pack	96
Service	97
Sending MC6 for Service	97
Firmware Update	97
Resetting MC6	97
The Battery Charger	98
Recalibrating MC6	98
Cleaning MC6	98
Statements	99
Disclaimer	99
CE.....	99
Intellectual Property Rights	100
Copyright.....	100
Trademarks.....	100
Index	101

FEEDBACK

We want to improve our products and services constantly. Therefore we'd like to know Your opinion of the product You use. Please spend a moment of Your valuable time in filling this form. All respondents will receive a surprise gift in return.

Certain questions can be answered immediately after receiving the product. Others require some use of the product before You are able to answer them. The best way to fill the form is to answer the items as it applies, and send the form to us when all items are answered. There are however no definite restrictions; fill in the form when you feel like it (all items need not be answered). Then send it to Beamex using one of the possibilities listed to the right.

Mail: **Beamex Oy Ab**
Quality Feedback
Ristisuonraitti 10
FIN-68600 Pietarsaari
FINLAND

Fax: **+358 - 10 - 5505404**
Only the next page needs to be faxed to us.

Internet: **<https://www.beamex.com>**
A similar form is available as a web page

E-mail: **support@beamex.com**
Refer to the numbered items on the next page in Your e-mail message.

1. Name of the product you give feedback of:

2. Serial number and software version number

_____ / _____ (if applicable)

3. Any comments when receiving the product. Did the package contain all required items and was it as expected?

4. For how long have you been using the product?

5. How helpful was the manual in using the product?
(Tick a box in the percentage scale below)

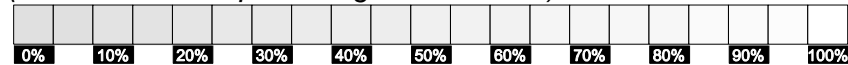

6. How well did the product suit your needs?

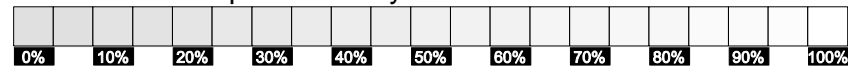

7. How satisfied are you with the product?

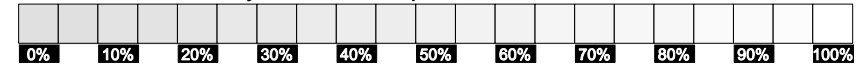

8. Did anything in the product exceed your expectations? In that case, what was it?

9. Did anything in the product disappoint you? In that case, please specify.

10. Any ideas You want to propose to Beamex so that we can improve our products, operations and/or services.

Title & Name: _____

Address: _____

- Please contact me concerning the Feedback I have given.
- I want to receive more information on Beamex products.

Part 1

Things discussed in this part:

- About this manual
- Briefly about MC6's hardware and firmware
- Available software and hardware options

INTRODUCTION

GENERAL

Thank you for buying Beamex MC6 Advanced Field Calibrator and Communicator. Because of its versatile features, it really is "more than a calibrator".

MC6 is one device with five different operational modes: Meter, Calibrator, Documenting Calibrator, Data Logger and Fieldbus Communicator.

Attention!

Before taking MC6 into use, please read the warnings available in Appendix.

ABOUT THIS MANUAL

MC6 User Manual is divided into several parts as follows:

- **Part 1, Introduction** discusses general matters.
- **Part 2, Active Terminals and Connections.** Whatever you measure, generate or simulate, here's how to make the necessary connections.
- **Part 3, Meter** introduces the metering tool, which is handy for making quick measurements. One measurement at a time.
- **Part 4, Calibrator.** A more versatile tool which allows you to measure/generate/simulate two things simultaneously etc.
- **Part 5, Documenting Calibrator** concentrates on instrument calibration using the full featured documenting calibrator.
- **Part 6, Data Logger.** Collecting and reviewing data and transferring logged data to a PC.
- **Part 7, Communicator.** Invoking digital communication with modern instruments.
- **Part 8, Settings.** How to customize MC6 and what the **About** window contains.
- **Part 9, Additional Information.** About advanced tools for, e.g. adding custom pressure units, connecting external devices etc.

WHERE AM I?

The header of each spread in MC6 User Manual informs you of where you are: The even page shows the part you are in and the odd page shows the main topic you are currently viewing.

Example of even page header:

2 MC6 User Manual – Part 1, Introduction

Example of odd page header:

General - About This Manual 3

TYPOGRAPHICAL CONVENTIONS

The following typographical conventions apply to MC6 User Manual:

Bold text is used in following situations:

- References to User Manual topics and parts,
- MC6 keywords, i.e. terms shown in the User Interface and
- other keywords, e.g. the names of fieldbus parameters.

Notes are shown in Narrow text with a border above and to the left of the note text. Notes typically inform you of something useful concerning the current topic.

Warnings are shown in Narrow and Bold. They also have a shaded background and are surrounded by a border line. Whenever you see a warning, read it carefully and take it seriously. By not observing warnings, you may - at worst - damage the calibrator and/or even risk your life.

UNPACKING AND INSPECTION

At the factory each new MC6 passes a careful inspection. It should be free of scrapes and scratches and in proper operation order upon receipt. The receiver should, however, inspect the unit for any damage that may have occurred during transit. If there are signs of obvious mechanical damage, package contents are incomplete, or MC6 does not operate according to specifications, contact the purchasing sales office as soon as possible.

If you have to return the instrument to the factory for any reason, use the original packing whenever possible. Include a detailed description of the reason for the return. Read also chapter **Sending MC6 for Service** in **Appendix**.

For a description of available options, see **Options** on page 13.

Standard accessories:

- Accredited calibration certificate,
- this User Manual,
- Warranty Card,
- pre-installed internal rechargeable Lithium Polymer (LiPo) batteries,
- test leads,
- clips as follows:
 - * a pair of Grabber clips and
 - * two pairs of Alligator clips,
- battery charger/eliminator and
- USB cable.

ABOUT MC6

STARTING MC6

Start MC6 by pressing the **Power** button for a few seconds. The startup procedure ends in **Home View** (see picture on the right). From MC6's **Home View** you may advance to any of the available main functions. This manual contains detailed information of main functions as follows:

- **Meter** in Part 3,
- **Calibrator** in Part 4,
- **Documenting Calibrator** in Part 5,
- **Data Logger** in Part 6,
- **Communicator** in Part 7 and
- **Settings** in Part 8.

With the **Home** button (see picture on the right) you can always return to **Home View** from wherever you are.

When MC6 is already running, pressing the **Power** button briefly opens a dialog with the following options:

- **Power Off** to shut down MC6 in **Backup Mode**, i.e. minimum power consumption and full startup procedure.
- **Standby** to set MC6 in **Standby Mode** allowing faster startup when the **Power** button is pressed again.
- **Backlight Off** to temporarily set the backlight off.

The button on the right side of the dialog:

- **Power Management** to define Backlight Brightness and other power management related settings. More in Part 8, **Settings**.



Power button (left) and Home button (right).

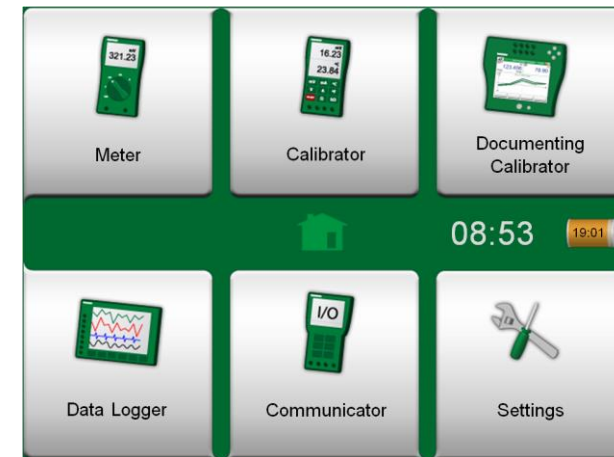

Home View

Note.

Certain main functions are options. They may not be available in your MC6. More of this in chapter **Options** on page 13.

FIRMWARE

You can interact with MC6 by tapping on available buttons/controls displayed on the touch screen. Optionally: use the hardware arrow keys to move between the available buttons/controls. The first time you push a hardware arrow key the **Hardware Focus Indicator** is displayed (a blue border around the active button/control). When using the hardware arrow keys, use the hardware Enter key to select ("tap") a button/control.

Buttons often open a pop-up window for entering data, e.g. a unit button with the text "mmH₂O" opens a pop-up window of available units. Certain buttons do have special functionality, like "**Accept**" and "**Close**" buttons. They close a pop-up window and either accept or reject the changes. There are other buttons, e.g. for going to the next/previous page pages, scrolling through a wide table of data, removing a number in a numeric field (backspace), clearing a numeric field, etc. Most of them are familiar since they look similar as in personal computer software.

One important button is the **Menu** button which is available in the upper left corner of almost any window. Tap on it to open a context-sensitive menu with, among other things, a software version of the **Home** button presented on previous page.

Check Boxes are special buttons that are either "checked" or "unchecked". See picture below. Again, the functionality is familiar from personal computers.



Check Boxes, both a checked and an unchecked one.

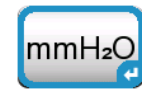

Button without and with a Hardware Focus Indicator.



Accept button.



Close button.



Menu button to the left.

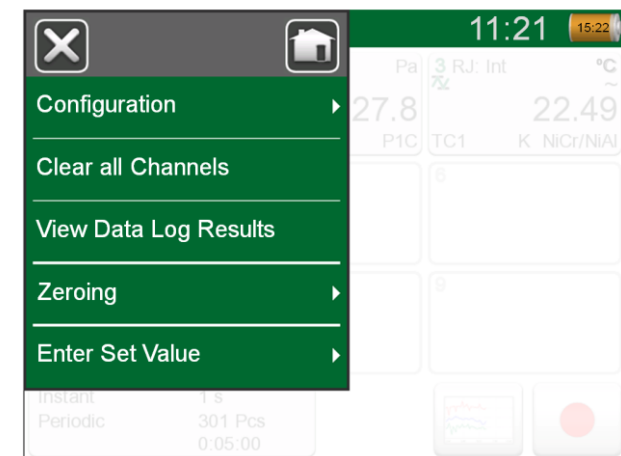

Example of an opened menu.

MC6 also has some "flat" buttons. They are used in, e.g. lists. The color of the flat buttons may vary depending on the context.

The following editable fields are available:

- **Text Fields,**
- **Numeric Fields,** in certain cases including **Spinning** and
- **Date/Time Fields.**

The letters/numbers on all editable fields are blue to indicate that they are editable. Black texts are descriptive user interface texts that are not editable. An example of a Text Field and the Text Edit Window is at the bottom right of this page.

Use of Numeric Fields and Spinning is described in **Part 2, Active Terminals and Connections** and **Part 5, Documenting Calibrator.**

Date Fields are actually special cases of Numeric Fields. Entering the date is just like entering any numeric value.

Setting MC6's time is a special case of the Spinning functionality. See picture below. The "**Left**" and "**Right**" arrow buttons move the highlight to another digit. The "**Up**" and "**Down**" arrow buttons change the value of the highlighted digit.

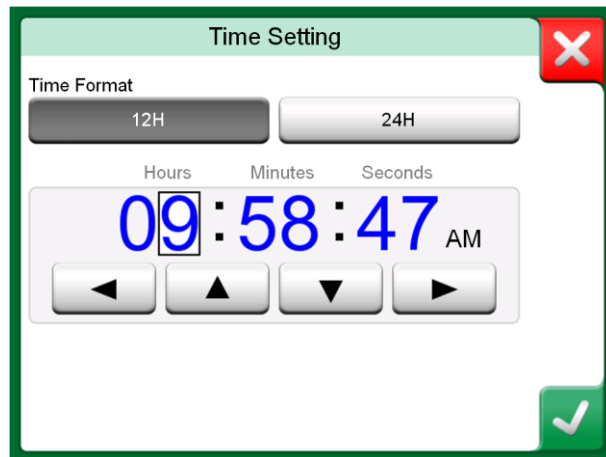

Time Setting window

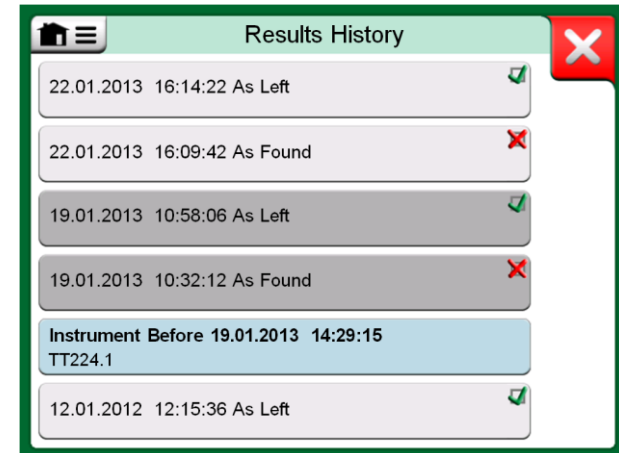

Example of a list with flat buttons.

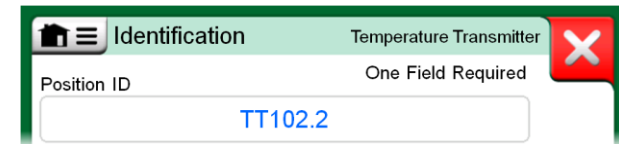

Text Field

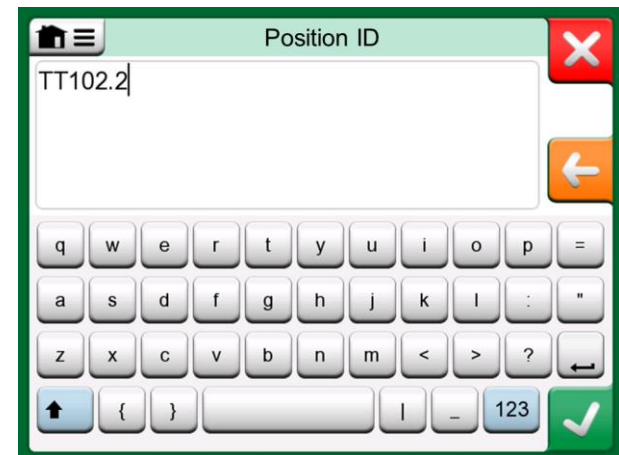

Text Edit window

HARDWARE

GENERAL

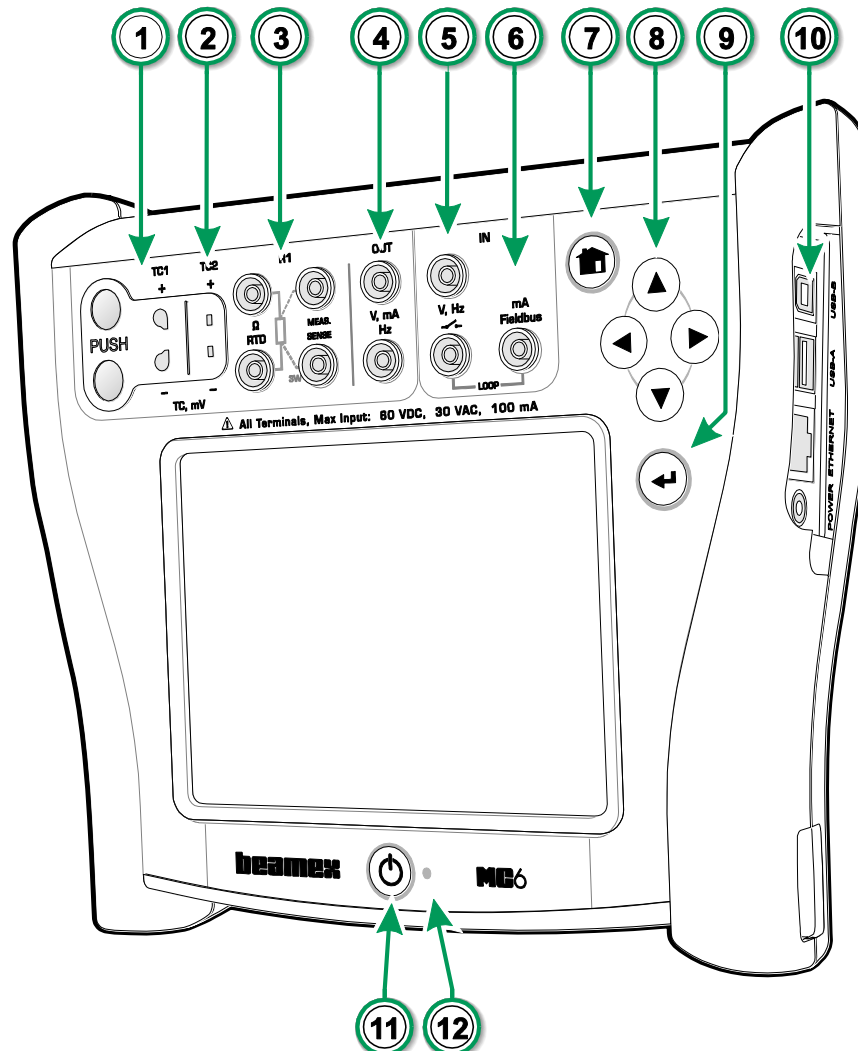

Legend:

1. **Thermocouple** connector (TC1) with release buttons. For cables and standard TC plugs.
2. **Thermocouple** connector (TC2). For TC plugs with flat contacts.
3. **RTD and Resistor** connector (R1). An R2 connector is on the top of MC6. More of R2 connector on next page.
4. **Voltage, Current and Frequency** output (OUT).
5. **Voltage, Frequency and Switch** input (IN).
6. **Current Measurement, Loop Supply, HART® and Fieldbus** connection (IN).
7. **Home** button. Press this button to return to **Home View**.
8. **Arrow** buttons. First press displays the **Hardware Focus Indicator**. Further presses move the indicator on the touch screen.
9. **Enter** button for selecting the item surrounded with the **Hardware Focus Indicator**.
10. **Connectors** on the right side of MC6. More in chapter **Connectors on the Right Side of MC6** on page 8.
11. **Power** button. More in chapter **Starting MC6** on page 4.
12. **Light Emitting Diode (LED)**. More in chapter **About the Charger and the Charging Procedure** on page 10 and **LED** on page 11.

MC6, front and right side shown.

CONNECTORS ON TOP OF MC6

Items from left to right:

- **R2.** A possibility to connect an external RTD sensor to MC6. See also **Hardware Modules/Options and Accessories** on page 14.
- **P1 to P3.** Internal Gauge Pressure Module connectors. These are optional. You may have zero to three Internal Gauge Pressure Modules on your MC6. See also note to the right and chapter **Internal Barometric Pressure Module** on page 9.
- **PX.** A possibility to connect Beamex External Pressure Modules to MC6. See also adjacent warning.

If you use other pressure hoses than the one delivered by Beamex, remove the connector meant for Beamex's pressure hoses and replace them with your own connectors. The thread available in a Pressure Module's body is *1/8" BSP*.

R2 connector's pin order:
Outside view of the female connector in MC6.

- 1 Excitation current +
- 2 Sense +
- 4 Sense -
- 5 Excitation current -

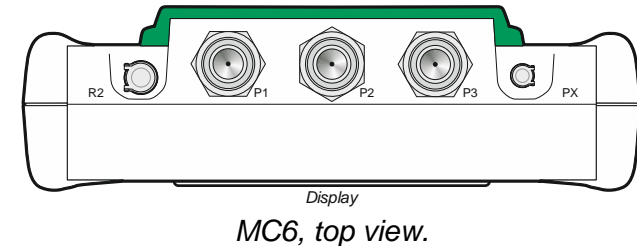
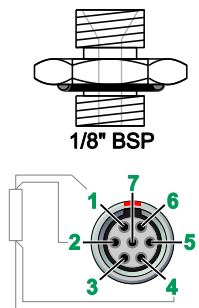

MC6, top view.

Warning!

After cleaning the overpressure blow holes of pressure modules, tighten the pressure module shield (green highlight in picture above) using max 0.4 Nm torque.

Note.

If the top view of your MC6 is different, you have the flatter back side installed. Then your MC6 does not have any internal pressure modules, except possibly a barometric module.

Note.

Leave pins 3, 6 and 7 unconnected in the male connector meant for MC6's R2 connector.

CONNECTORS ON THE RIGHT SIDE OF MC6

The Connectors on the right side of MC6 are:

- **Power** for charging the calibrator. More in chapter **About the Charger and the Charging Procedure** on page 10.
- **Ethernet** connector for connecting MC6 to a Local Area Network. This is a future expansion.
- Two **USB-A** connectors for connecting USB devices to MC6. See also chapter **Firmware Update** in the **Appendix**.
- **USB-B** connector for communicating with a Personal Computer. For details concerning communication, see **PC Communication / Calibration Software** on page 12.

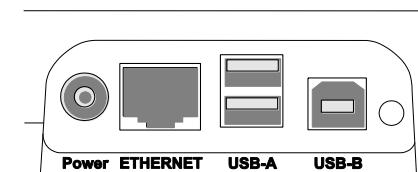

Connectors on the right side of MC6

Note.

All USB connectors are USB 2.0 Full Speed ports.

INTERNAL BAROMETRIC PRESSURE MODULE

The optional Internal Barometric Pressure Module is located inside MC6. It has a venting hole on the back side of MC6. To ensure valid barometric pressure measurements, do not plug the venting hole.

MEMORY

MC6 maintains data very much like personal computers. Data is saved on a solid state memory that does not need any power to maintain its state. Solid state memory is shock-proof so the data is not lost when the calibrator is transported. Also, you can safely save a large amount of instruments, calibration results and data log results.

Available memory can be used for anything that requires it (e.g. instrument data, calibration results etc.).

DISPLAY

MC6 has a backlit 640 × 480 pixel 5.7" TFT touch screen display. Use the touch screen with your fingers, gloves on or off. Optionally, use a stylus meant for touch screen use.

See also brightness settings in **Part 8, Settings**.

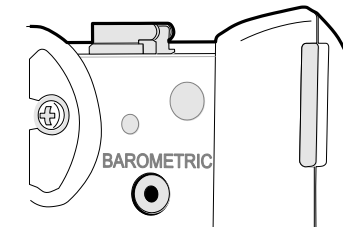

Venting hole of the Internal Barometric Module.

Note.

The Internal Barometric Pressure Module is not located in the space reserved for Internal Gauge Modules, so you may have both a barometric module and up to three gauge modules in your MC6.

Warning!

Using sharp tools such as a screwdriver on the touch screen may damage it. More warnings in Appendix.

BATTERIES

MC6 has internal rechargeable Lithium Polymer (LiPo) batteries. Since LiPo batteries do not suffer from the memory effect, they may be charged at any time. However, there are some serious safety issues concerning them, so read **Warnings Concerning the Lithium Polymer Battery Pack** in Appendix.

A picture of a battery (or a plug, when charging or running on AC power) is shown on many of MC6's views. The "content" of the battery corresponds to the approximated charge level of MC6's rechargeable batteries. See also chapter **LED** on page 11. The maximum operating time of the batteries without recharging varies depending on the usage of the display back light. The usage of the 24 V transmitter supply also affects the maximum operating time. Even with constant maximum load, the standard rechargeable batteries should last for 10 hours. A good average operating time is 16 hours.

ABOUT THE CHARGER AND THE CHARGING PROCEDURE

MC6 may be used while the batteries are charged. Charging time from empty to full batteries is approximately 4 hours.

When charging the batteries, the battery symbol and a plug symbol alternate on the status bar. When charging is ready, only the plug symbol is shown.

If MC6 is shut off and the charger is connected, a battery symbol appears. After a while, an estimate of the remaining charge time appears below the battery symbol.

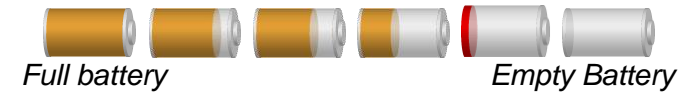

Notes.

A time approximate (hh:mm) is shown on the battery symbol. During charging it is the charging time left, otherwise it is remaining usage time. MC6's internal clock/calendar uses a small amount of power even when the calibrator is switched off. Remember to check the capacity of the batteries from time to time although MC6 is not in use. Recharge if needed. Tap the battery icon to open a window displaying detailed battery/charging information.

Warning!

USE THE CHARGER PROVIDED WITH THE CALIBRATOR ONLY. FURTHER WARNINGS PRESENTED IN CHAPTERS WARNINGS CONCERNING THE LITHIUM POLYMER BATTERY PACK AND CHARGING THE LITHIUM POLYMER BATTERY PACK, BOTH IN APPENDIX.

LED

MC6's Light Emitting Diode (LED) indicates battery/charging status as follows:

- When charger is connected and charging is in progress, the LED flashes approximately once every second.
- The LED is constantly lit when the charging of the batteries is ready (with charger still connected).
- When battery charge level is low, the LED is lit for a second in approx. 10 second intervals.

REMOVING/REPLACING THE BATTERY PACK

To remove or replace the Lithium Polymer batteries, perform the following procedure:

1. **Important!** Make sure charger is **not connected** to MC6.
2. Shut off MC6 and turn it upside down (the display facing the table top). Twist and remove the support.
3. Unscrew the four screws holding the battery compartment cover. See adjacent picture.
4. Bend the clip holding the battery pack connector and gently pull the connector out.
5. To replace the battery pack, push the connector of the new battery pack in its place (**noting the polarity!**) and put the battery pack in its slot. Note that MC6 immediately starts after the battery pack is connected.
6. Put the battery compartment cover back on place and fasten the battery compartment cover.
7. Press the support back on place.

"Teach" MC6 the capacity of the new battery pack by charging and fully discharging the battery pack at least once before taking it into normal use.

Important!
Read the warnings presented in chapter *Warnings Concerning the Lithium Polymer Battery Pack* in Appendix.

Note.

When batteries have capacity enough to continue working with MC6, the LED is not lit during normal operation.

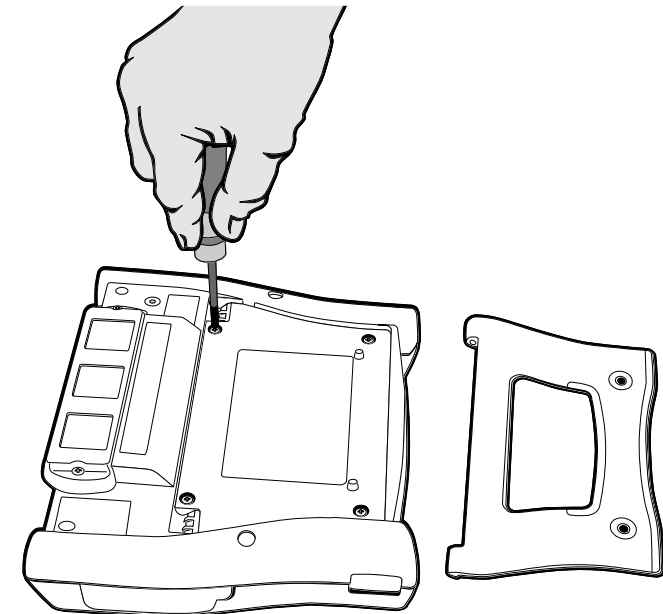

Removing/replacing the batteries

PC COMMUNICATION / CALIBRATION SOFTWARE

Beamex CMX Calibration Software supports MC6 from version V2, revision 2.7 onwards and also in **Beamex LOGiCAL**, a cloud based tool for handling calibration results.

USB COMMUNICATION DRIVER

MC6 uses Windows' generic USB driver (WinUSB) provided by Microsoft. Supported operating systems: Windows® 7 ... Windows® 10. Starting from Windows 8, the driver installation is self-contained, older versions may require Windows Update connection.

MC6 RELATED TOOLS AVAILABLE FOR PC

The following tools are available for download at Beamex's web site: <https://www.beamex.com>. Look for **Download Center and Software tools for MC6 family**.

- **Beamex MC6 Data Log Viewer**, for transferring Data Log results to a PC and viewing them on the PC.
- **Beamex MC6 Device Description Installer**, for installing new Device Descriptions of smart transmitters from a PC to MC6.
- **Beamex MC6 Fieldbus Configuration Viewer**, for downloading smart transmitter configurations read into MC6 to a PC.
- **Beamex MC6 Remote Controller**, for controlling MC6 via a PC.

OPTIONS

SOFTWARE OPTIONS

The following software options are available:

- **Documenting Calibrator** including computer communication with supported calibration software presented in chapter **PC Communication / Calibration Software** on page 12,
- **Mobile Security Plus**. This option requires that you have the **Documenting Calibrator** option in MC6 and **CMX Calibration Software** version V2, revision 2.11 or later.
- Multi channel **Data Logger**,
- **Communicator**, HART®,
- *)**Communicator**, FOUNDATION Fieldbus™,
- *)**Communicator**, PROFIBUS PA™,
- +)Drivers for **External Controllers** (Pressure and Temperature) and
- **Special Temperature Sensors**.

*) Requires that communicating hardware is installed into MC6. Please contact Beamex.

+) When necessary, a connection cable is shipped when the software option is bought.



Notes.

The software options available in the MC6 at hand can be found in MC6's **Settings** main function. Select **About** option and browse to page 3.

Whether the communication hardware needed for fieldbus communication is installed or not, can be found in MC6's **Settings** main function. Select **About** option and see page 1.

HARDWARE MODULES/OPTIONS AND ACCESSORIES

- **Internal Pressure Modules.** Up to three gauge and/or differential pressure modules may be installed and additionally a barometric module.
- Communicating hardware for MC6's **Communicator** software options. See also **Software Options** on page 13.
- **Adapter cables** for R2 connector. The R2 connector supports **Beamex Smart Reference Probe**.
- **Cable** for Pressure and Temperature Controllers.
- **Soft Carrying Case.**
- **Hard Carrying Case.**
- **Spare Battery Pack.**
- **Pressure Hose Sets** to be used together with internal and external **Pressure Modules**.

Note.

The Internal Pressure Modules available in the MC6 at hand can be found in MC6's **Settings** main function. Select **About** option and browse to page 2.

RELATED PRODUCTS

There are an increasing number of devices that can be used together with MC6. The following list includes devices that are already available (valid when this manual was printed):

- External Pressure Modules (EXT),
- Calibration hand pumps:
 - **PGV** vacuum pump,
 - **PGL** low pressure calibration pump,
 - **PGC** pressure/vacuum pump,
 - **PGM** high pressure pump,
 - **PGPH** high pressure pneumatic pump and
 - **PGXH** extra high pressure pump.
- Beamex **POC8** Automatic Pressure Controller,
- Beamex Field Temperature Block (**FB** Series),
- Beamex Metrology Temperature Block (**MB** Series),
- Beamex **CMX** Calibration Software and
- Beamex **LOGiCAL**, a cloud based tool for handling calibration results.

Part 2

Things discussed in this part:

- A presentation of measurements MC6 is capable of performing. For all measurements, the active terminals together with useful additional information for that particular measurement are presented.
- Similarly, a presentation of generations and simulations MC6 is capable of performing.
- For generations/simulations, there is also information on how to change the generated/simulated value.

ACTIVE TERMINALS AND CONNECTIONS

GENERAL

This section of MC6 User Manual presents all measurements and generations/simulations that MC6 is capable of performing. No matter which of the available main functions you use in MC6, the connections presented here apply.

Settings in **Meter** and **Calibrator** are saved, so the next time you measure, generate or simulate something, the previous settings are available as defaults.*

In **Calibrator** also the additional information row settings for all measurements/generations/simulations are saved for future needs. However damping, resolution and alarms are active for the current session only.

*) When you use **Documenting Calibrator** and select an instrument for calibration, the instrument's settings (**Quantity**, **Port** etc.) are inherited to the **Calibrator**.

Respectively, when creating a new instrument in **Documenting Calibrator**, the settings in **Calibrator**'s sub-windows are used as default settings for the new instrument's input and output.

Notes.

For HART and Fieldbus instrument specifics, see **Part 7, Communicator**.

For information on External Devices (Pressure and Temperature Controllers) used together with Calibrator and Documenting Calibrator, see **Part 9, Additional Information**.

Note.

In this manual, when presenting each measurement/generation/simulation there is a picture with highlighted active terminals. The highlight for possible optional connections is lighter. Connections to instruments are included if it requires special attention. See, e.g. **Current Generation (Source or Sink)** on page 24.

Next...

Measurements on page 17

Generations/Simulations on page 22

Meter in part 3

Calibrator in part 4

Documenting Calibrator in part 5

Data Logger in part 6

Communicator in part 7

Additional Information in part 9

MEASUREMENTS

PRESSURE MEASUREMENT

MC6 supports the use of both internal pressure modules, if installed, and the use of supported external pressure modules, **EXT**, when they are connected to MC6's **PX** connector.

Note that pressure measurement requires knowledge of **pressure types** (absolute pressure, gauge pressure and differential pressure). Measuring pressure with inadequate knowledge of pressure types and the dangers of pressure devices may result in false measurement results and/or serious accidents. **Please read the warnings in Appendix.**

CONNECTING AND DISCONNECTING EXTERNAL PRESSURE MODULES

When an external pressure measurement module is connected and when applicable, MC6 opens a dialog. Among other information, the dialog includes a possibility to choose where to use the connected external pressure module.

An external pressure module may be disconnected at any time. MC6 indicates that an external pressure module was removed. If the module was used for a measurement, the measurement stops.

ZEROING A PRESSURE MODULE

If the selected pressure module does not display zero gauge pressure when the applied pressure is zero, the module has to be zeroed. To do it, apply zero gauge pressure and tap the zero button:

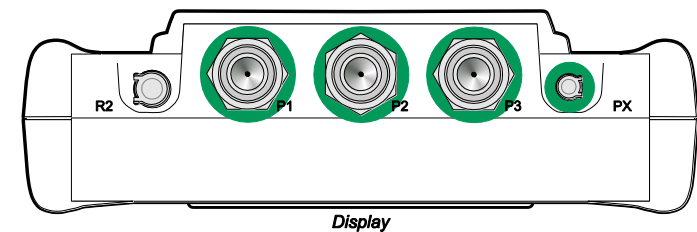

Internal pressure module connectors (P1 to P3) and connector for external pressure module's communication cable (PX).

Note.

The amount of internal pressure modules on your particular MC6 may differ from the picture presented here.

Warning!

Select a pressure module that has a suitable measurement range for your pressure signal. Too low/high measurement range on the pressure module results in faulty modules, imprecise readings or even accidents.

CURRENT MEASUREMENT

When measuring electric current, an important thing is selecting whether MC6 provides the 24 volt **loop supply voltage** or not. If not, an external device should provide the loop supply voltage.

Connection depends on the loop supply setting. See pictures to the right.

See also: **Current Generation (Source or Sink)** on page 24.

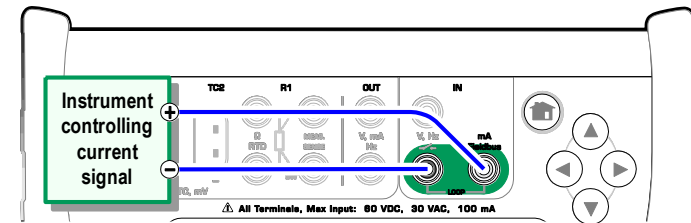

*Current measurement terminals. Internal supply
Range -101 ... +101 mA*

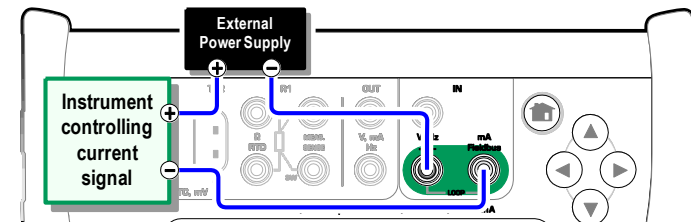

Current measurement terminals. External supply.

VOLTAGE MEASUREMENT

MC6's voltage measurement terminals are listed below (top to bottom) as they are shown in the adjacent picture (left to right):

- **TC1**, measurement range: -1.01 to +1.01 VDC.
- **TC2**, measurement range: -1.01 to +1.01 VDC.
- **IN**, measurement range: -1.01 to +60.6 VDC.

Note that you may measure non-supported thermocouple signals using either **TC1** or **TC2** port. The reading is in (milli)volts, so you need a data table to convert the signal to temperatures. **Calibrator's** and **Documenting Calibrator's Scaling** utility may be used for converting millivolts to temperatures.

See also: **Voltage Generation** on page 24 and **Temperature Measurement (Thermocouple)** on page 19.

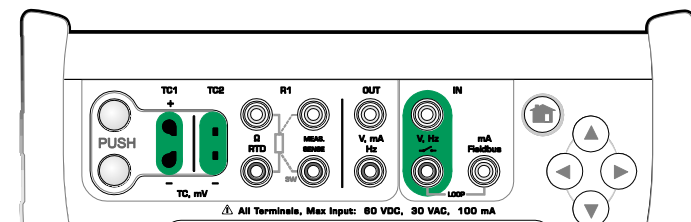

*Voltage measurement terminals.
For ranges, see chapter to the left.*

Warning!
Do not apply hazardous voltages to MC6's terminals.

TEMPERATURE MEASUREMENT (THERMOCOUPLE)

MC6 has two thermocouple connectors. **TC1** is for cables and standard TC plugs. **TC2** is for TC plugs with flat contacts.

Check the **Sensor Type**. Your measurement results are unreliable unless you select the same sensor type as is connected to MC6. Select also a suitable **Reference Junction** compensation method. Wrong settings yield useless measurement results.

See also: **Thermocouple Simulation** on page 25 and **Voltage Measurement** on page 18.

Warning!

When using another thermocouple or an RTD sensor connected to MC6 to measure the external reference junction temperature: Keep in mind that there is no isolation between the thermocouple to be calibrated and the sensor measuring the reference temperature.

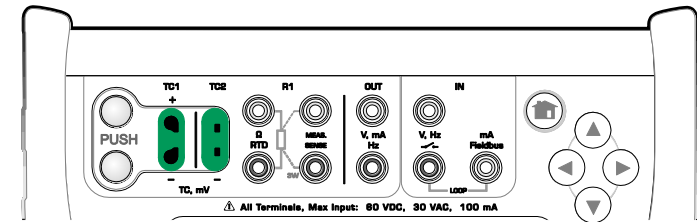

*Thermocouple measurement terminals.
Range depends on sensor type*

Note.

Thermocouple measurements are error prone. There may be faulty connections, wrong (extension) cables and settings in MC6. If unsure, see chapter **Thermocouple Connections** on page 28 and study thermocouple literature.

TEMPERATURE MEASUREMENT (RTD)

Check the **sensor type**. Make sure you select the same sensor type as is connected to MC6. Otherwise your measurement results are unreliable.

For R1 terminals:

The two leftmost terminals are used in 2-wire systems. MC6 automatically checks the connection and displays the found wiring system.

For R2 terminal:

Beamex offers, as an option, an adapter for the R2 terminal. Please contact Beamex for details. R2 terminal always uses 4-wire measurement.

See also: **RTD Sensor Simulation** on page 25, **Resistance Measurement** on page 20 and **Resistance Simulation** on page 26.

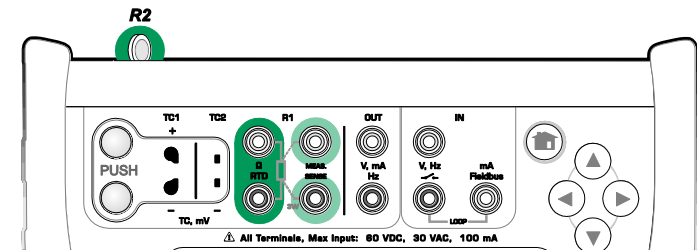

*RTD measurement terminals.
Range depends on sensor type*

Note.

If you get "+OVER" or "-OVER" error messages, check the connections. If necessary, use 2-wire ohm measurement to check the wiring.

Note.

To ensure good contact between the device under test and the test leads, we recommend using the alligator clips provided with MC6.

RESISTANCE MEASUREMENT

For R1 terminals:

The two leftmost terminals are used in 2-wire systems. MC6 automatically checks the connection and displays the found wiring system (2-wire, 3-wire or 4-wire).

For R2 terminal:

Beamex offers, as an option, an adapter for the R2 terminal. Please contact Beamex for details. R2 terminal always uses 4-wire measurement.

See also: **Resistance Simulation** on page 26 and **Temperature Measurement (RTD)** on page 19.

Note.

To ensure good contact between the device under test and the test leads, we recommend using the alligator clips provided with MC6.

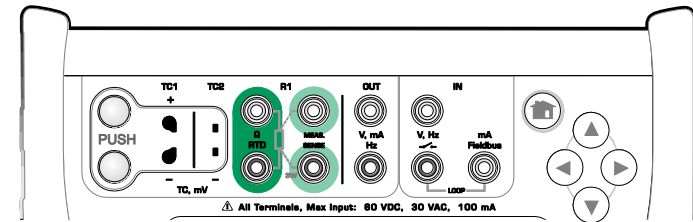

*Resistance measurement terminals.
Range -1 ... 4040 ohm*

Note.

If you get "+OVER" or "-OVER" error messages, check the connections. If necessary, use 2-wire ohm measurement to check the wiring.

FREQUENCY MEASUREMENT

In frequency measurement, be sure you select a suitable **trigger level** setting. To do it, tap on the button with the arrow pointing on a rising ramp and the current trigger level voltage. From the opened pop-up window: Select a suitable trigger level.

See also: **Frequency Generation** on page 26, **Pulse Counting** on page 21 and **Switch Sensing** on page 21

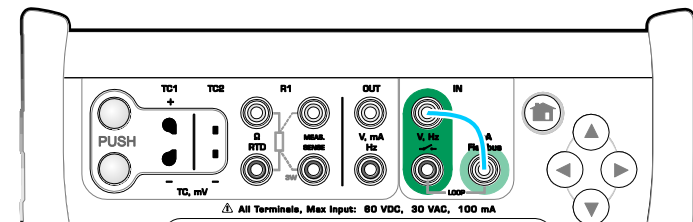

*Frequency measurement terminals.
Range 0.0027 ... 51000 Hz*

Note.

There is a trigger level choice for (dry) contacts with no external potential. 24V supply may also be used. Connect as light blue line shows in picture above.

PULSE COUNTING

Pulse counting has three settings that should be checked before (re)starting a pulse count:

- **Trigger level.** Select a level that suits your signal.
- **Trigger edge.** Select either rising or falling edge.
- **Zeroing.** A possibility to zero the pulse count.

See also: **Pulse Generation** on page 27,
Frequency Generation on page 26 and
Frequency Measurement on page 20.

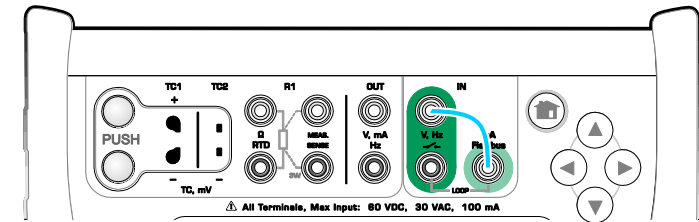

*Pulse counting terminals.
Range 0 ... 9 999 999 pulses*

Note.

There is a trigger level choice for (dry) contacts with no external potential. 24V supply may also be used. Connect as light blue line shows in picture above.

SWITCH SENSING

Switch Sensing has three settings:

- A possibility to **invert** switch's open/close state indication.
- **Trigger level.** Select a level that suits your switch. See note to the right.
- **Sound setting.** Define whether MC6 emits a sound when the switch's state change and if yes, when it is emitted.

See also: **Pulse Counting** on page 21 and
Pulse Generation on page 27,

You can also use Switch Sensing for binary signal detection. For normal switch state detection: an open switch equals **1 / True** and a closed switch **0 / False**.

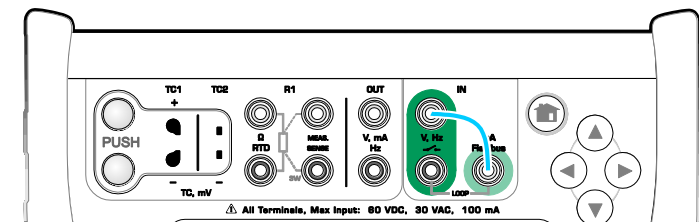

Switch sensing terminals.

Note.

There is a trigger level choice for (dry) contacts with no external potential. 24V supply may also be used. Connect as light blue line shows in picture above.

GENERATIONS/SIMULATIONS

Generations and simulations are supported in **Calibrator**, **Documenting Calibrator** and **Data Logger**.

Note.

The **Meter** is not capable of performing generations and simulations.

CHANGING THE GENERATED/SIMULATED VALUE

There are several ways of changing the generated/simulated value. The following subchapters present the available utilities.

USING THE SOFT NUMERIC KEYPAD

This utility is useful when a generated/simulated value (or any numeric field in MC6) is either empty (displaying dashes) or when a new and different value is needed. The soft numeric keypad opens when you tap on the generated/simulated value (see picture to the right). Tap on numbers to enter a value. Additional functions:

- Use the "**C**" key on the right to clear the entered value.
- Use the "**Left Arrow**" key to delete the number to the left of the cursor.

The entered value is taken into use when you close the window using the "**Accept**" button. Note that MC6 may use the entered value as a source for the value's resolution. Enter trailing zeros to ensure useful resolution.

When applicable, the minimum and maximum limit of the entered value is shown above the entered number. If you enter a value above/below the limits, and try to accept it, MC6 stays in the soft numeric keypad window and replaces the entered value with appropriate limit value and highlights the replaced value.

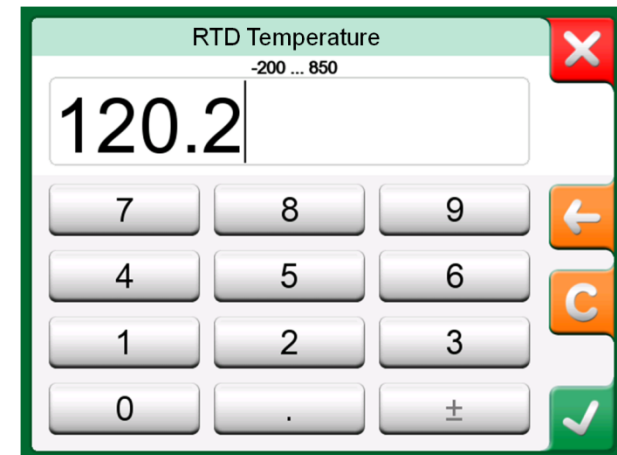

Soft Numeric Keypad.

SPINNING

Spinning is a tool that is available in **Calibrator** and **Documenting Calibrator**. It is useful when making small changes to an existing numeric value, one digit at a time.

Non-empty numeric fields in Calibrator's generation/simulation windows have a button with both "Up" and "Down" arrows to the left of the actual numeric value. That is the **Spinner** button. Tap the **Spinner** button to activate spinning.

When spinning is active, one of the digits is highlighted. Change its value by tapping the "**Up**" and "**Down**" arrows in the active spinner. To move the highlight to another digit, use the "**Left**" and "**Right**" arrows.

To stop spinning, tap the **Spinner** button again.

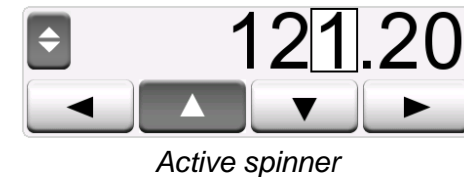

Notes.

Any changes in the numeric field are immediately reflected in the generated/simulated signal.
You cannot exceed the minimum/maximum limits of a Function when spinning.
The spinned value follows the resolution properties of the generated/simulated Function.
If a numeric field is empty (displaying dashes), first use the soft numeric keypad to enter a value. Then you are able to utilize the spinning tool.

CURRENT GENERATION (SOURCE OR SINK)

MC6's current generation can be done using one of two available methods:

- MC6 provides a 24 volt loop supply voltage (source mode).
Setting: **Supply: On**.
- An external device provides the loop supply voltage (sink mode)
Setting: **Supply: Off**.

Connection depends on the loop supply setting. See pictures to the right.

See also: **Current Measurement** on page 18.

Note.

If the connected instrument utilizes digital communication and MC6's 24 volt supply voltage is in use, the following battery symbol is shown in the user interface of **Documenting Calibrator** and **Data Logger**: 

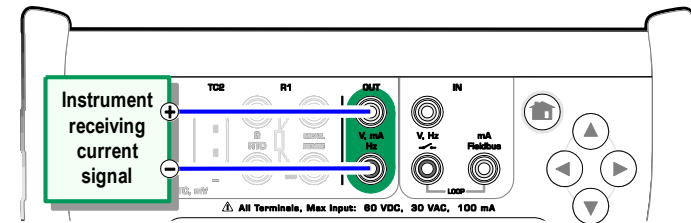

*Current generation terminals. Internal supply.
Range 0 ... 55 mA*

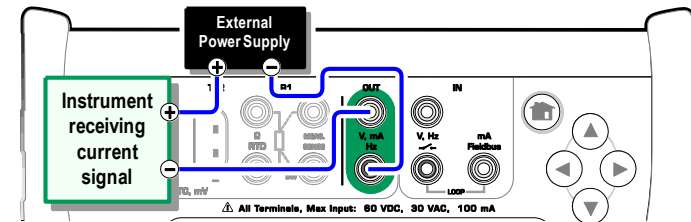

Current generation terminals. External supply

VOLTAGE GENERATION

MC6 has two voltage generation terminals. They are listed below (top to bottom) as they are shown in the adjacent picture (left to right):

- **TC1**, generation range: -1 to +1 VDC.
- **OUT**, generation range: -3 to +24 VDC.

Note that you may simulate non-supported thermocouple signals using **TC1** port. Since you actually generate (milli)volts, you need a data table to convert desired temperatures to millivolts.

See also: **Voltage Measurement** on page 18 and **Thermocouple Simulation** on page 25.

Note.

It is advisable to enter 0 V output before connecting the circuit.

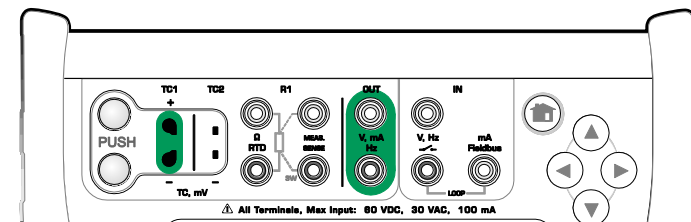

*Voltage generation terminals.
For ranges, see chapter to the left.*

Warning!

Short circuiting the voltage output may result in damage to MC6 and/or the connected instrument.

THERMOCOUPLE SIMULATION

Thermocouple simulation is available from TC1 terminals only.

Check the **Sensor Type**. Your simulations are unreliable unless you select the same sensor type as is connected to MC6. Also select a suitable **Reference Junction** compensation method. Wrong Reference Junction setting yields useless results. See chapter **Thermocouple Connections** on page 28.

See also: **Temperature Measurement (Thermocouple)** on page 19.

Warning!

When using a thermocouple or an RTD sensor connected to MC6 to measure the external reference junction temperature: Keep in mind that there is no isolation between the instrument to be calibrated and the sensor measuring the reference temperature.

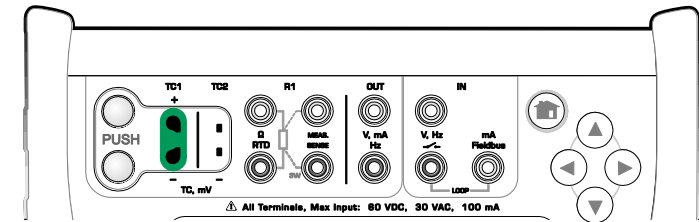

*Thermocouple simulation terminals.
Range depends on selected sensor type*

Note.

Thermocouple measurements are error prone. There may be faulty connections, wrong (extension) cables and settings in MC6. If unsure, see chapter **Thermocouple Connections** on page 28 and study thermocouple literature.

RTD SENSOR SIMULATION

RTD simulation is available from R1 terminals only.

Use of 2-, 3- or 4-wire connection is up to the receiving instrument. Connect the possible third and fourth wire according to the requirements of the connected instrument, but **use only the two leftmost R1 terminals in MC6**. See adjacent picture.

Check the **Sensor Type**. Make sure you select the same sensor as the instrument receiving the simulated signal requires. Otherwise your simulations are unreliable. See also note in next chapter.

See also: **Temperature Measurement (RTD)** on page 19 and **Resistance Simulation** on page 26.

Note.

To ensure good contact between the device under test and the test leads, we recommend using the alligator clips provided with MC6.

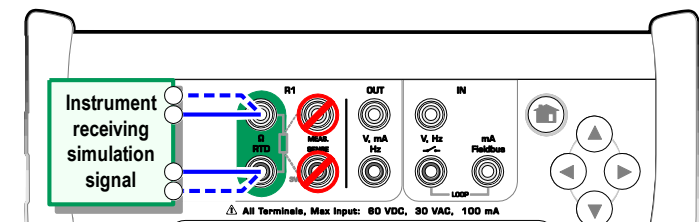

*RTD simulation terminals.
Range depends on selected sensor type*

Notes.

AC measurement current from the instrument under test is not supported. With pulsed measurement current, set a wait time of few milliseconds before the resistance is measured.

RESISTANCE SIMULATION

Use of 2-, 3- or 4-wire connection is up to the receiving instrument. Connect the possible third and fourth wire according to the requirements of the connected instrument, but **use only the two leftmost RTD1 terminals in MC6**. See adjacent picture.

MC6 monitors the resistance measurement current. If the current is too high, MC6 cannot simulate the right resistance value and displays an error message.

See also: **Resistance Measurement** on page 20 and **RTD Sensor Simulation** on page 25.

Notes.

When simulating resistance or an RTD sensor, using R1 port, MC6 does not support measuring the simulated signal using R2 port.

To ensure good contact between the device under test and the test leads, we recommend using the alligator clips provided with MC6.

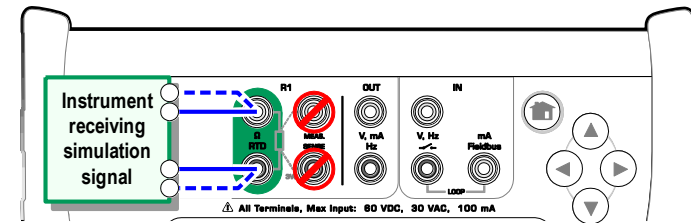

*Resistance simulation terminals.
Range 0 ... 4000 ohm*

Notes.

AC measurement current from the instrument under test is not supported. With pulsed measurement current, set a wait time of few milliseconds before the resistance is measured.

FREQUENCY GENERATION

Before generating frequencies, the following settings should be checked:

- **Amplitude.** Defined from the button with the "V" value.
- **Waveform and Duty Cycle.** Set together from the rightmost button.

Duty Cycle is the ratio of the output high time to the total cycle time. Due to technical reasons, the entered Duty Cycle is not always realized with relatively high frequencies. When the realized Duty Cycle differs from the desired Duty Cycle, the realized Duty Cycle is shown with an asterisk (*) in front of it, e.g.:

 *8 %

See also: **Frequency Measurement** on page 20 and **Pulse Generation** on page 27.

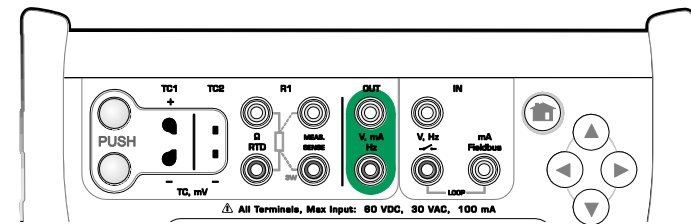

*Frequency generation terminals.
Range 0.0005 ... 50000 Hz*

PULSE GENERATION

Before generating pulses, the following settings should be checked:

- **Frequency.** To set the frequency, tap on the button with the "Hz" value.
- **Amplitude.** Defined from the button with the "V" value.
- **Waveform and Duty Cycle.** Set together from the rightmost button.

Duty Cycle is the ratio of the output high time to the total cycle time. Due to technical reasons, the entered Duty Cycle is not always realized with relatively high frequencies. When the realized Duty Cycle differs from the desired Duty Cycle, the realized Duty Cycle is shown with an asterisk (*) in front of it, e.g.:

 *8 %

See also: **Pulse Counting** on page 21 and **Frequency Generation** on page 26.

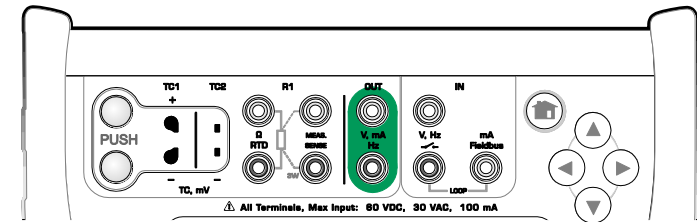

*Pulse generation terminals.
Range 0 ... 9 999 999 pulses*

THERMOCOUPLE CONNECTIONS

With thermocouples, connections and reference junction settings are crucial for getting accurate results. Reference Junction Modes available:

Internal is the simplest. Use suitable thermocouple, extension or compensation wires to connect to MC6. MC6 takes care of the Reference Junction compensation. The upper picture to the right presents the connection to TC1 terminals. You may optionally also use the TC2 terminals.

External R1 and **External R2** use an external RTD sensor measuring the Reference Junction temperature, connected to selected terminal. The lower picture to the right presents the connections to TC1 and R1 terminals.

Fixed (0°C) and **Manual** are used when a compensation box, a temperature controller or similar method is utilized for fixing the Reference Junction temperature. **Manual** allows you to enter any temperature. **Fixed (0°C)** is a quick way of "entering" zero degrees centigrade. Connection picture to TC1 below.

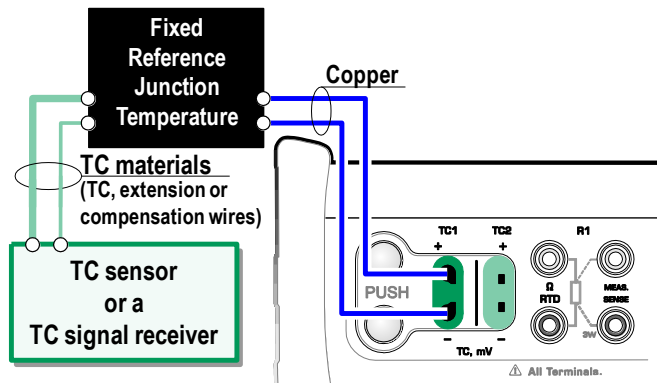

Fixed/Manual Reference Junction temperature.

Before measuring, ensure that MC6's temperature has stabilized. Temperature differences between MC6 and the environment affect the accuracy of TC measurements. In extreme conditions, wait up to 90 minutes.

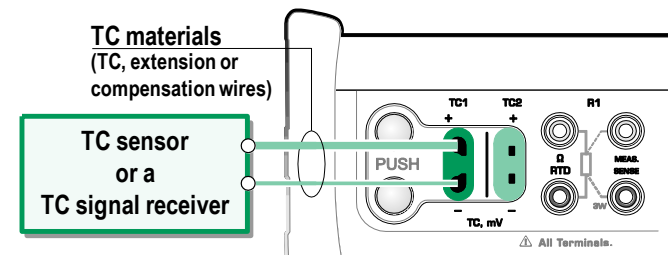

Internal Reference Junction.

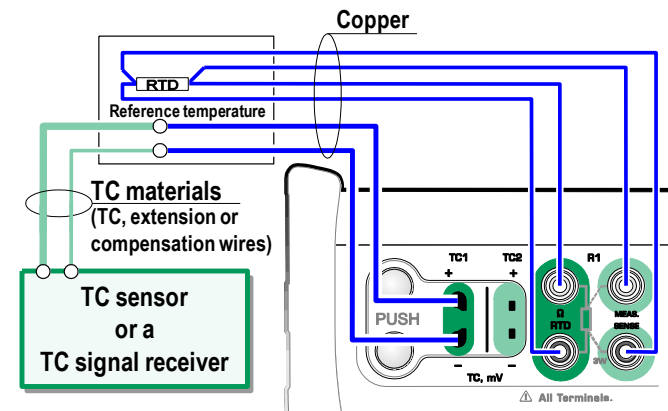

An RTD connected to R1 terminals measures the Reference Junction temperature.

Part 3

Things discussed in this part:

- Presenting the Meter and how to take it into use.

METER

ABOUT METER

The **Meter** can be used for quickly checking any device producing a signal that is measurable with MC6. For calibration needs, use one the calibration related main functions available in MC6.

Start the Meter by tapping the Meter icon in MC6's Home View (see adjacent picture). A window like the one on the lower right corner of this page opens. To measure a signal, do as follows:

- Select the **Quantity** of the signal by tapping one of the nine buttons on the lower part of the Meter window.
- Other, Quantity dependent settings appear on top of the Meter window.

For information on connections and essential settings, see **Part 2, Active Terminals and Connections**.

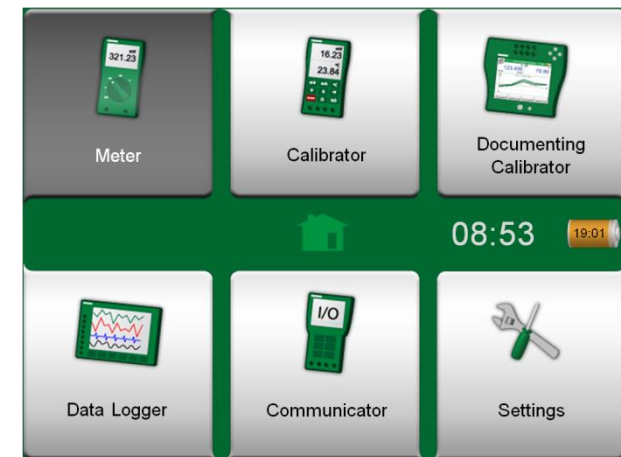

Home View with Meter selected

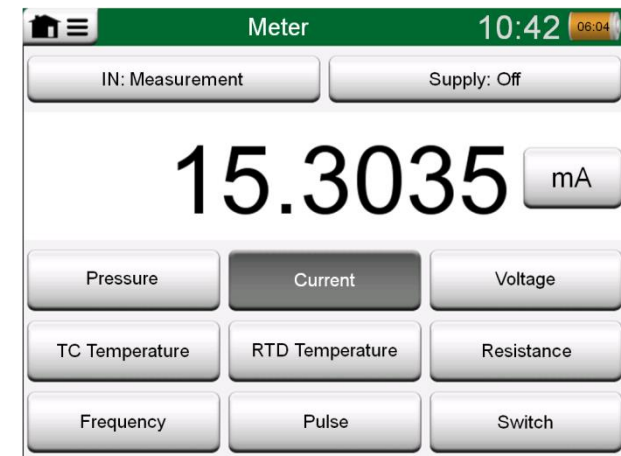

Current Measurement using Meter

Part 4

Things discussed in this part:

- How to use the Calibrator
- Presenting the available additional Tools in Calibrator



CALIBRATOR

ABOUT CALIBRATOR

The **Calibrator** can be used for calibrating instruments. It consists of two sub-windows which can be independently* configured to measure, generate or simulate a signal. One sub-window for the instrument's input and another for the instrument's output.

Start the **Calibrator** by tapping on the Calibrator icon in MC6's Home View (see adjacent picture). A window like the one on the lower right corner of this page opens. To configure a sub-window do as follows:

- Select the **Quantity** of the signal by tapping the button in the upper left corner of the sub-window. Hint: Quantity button has bold font.
- Other, Quantity dependent settings appear to the right of Quantity button. The button closest to the Quantity button defines whether you measure, generate or simulate a signal and which terminals are active.

For information on connections and essential settings, see **Part 2, Active Terminals and Connections**.

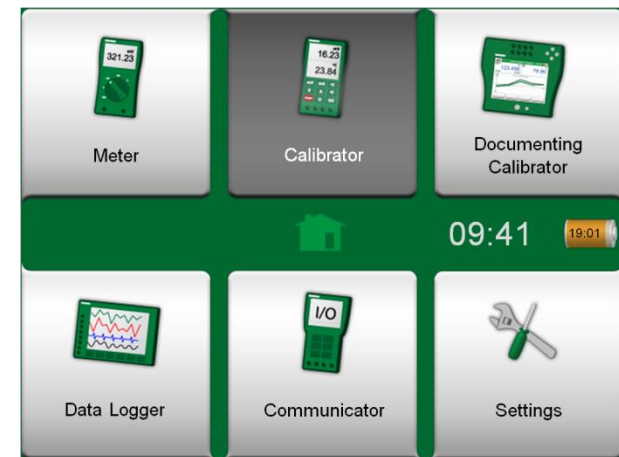

Home View with Calibrator selected

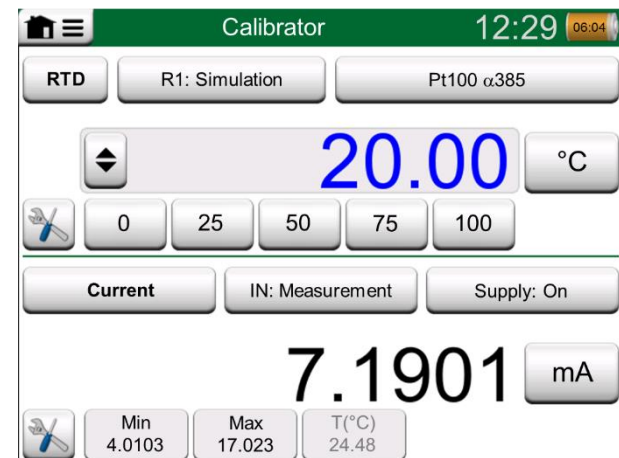

Calibrator in use

Note.

If you want to document your calibration results, use MC6's optional **Documenting Calibrator** feature or manually document the calibration data displayed in **Calibrator**.



For information on External Devices (Pressure and Temperature Controllers) used together with Calibrator, see **Part 9, Additional Information**.

*) A measurement, generation or simulation in one sub-window reserve terminals in MC6. This may affect the availability of measurements, generations and simulations in the other sub-window. To free terminals, tap on the quantity button and in the opened window, tap on the "**Stop**" button.

TOOLS

GENERAL

Calibrator window has **Tools** buttons in the lower left corner of each sub-window. See the picture to the right. The following list presents available tools. Certain tools are available for measurements only and others for generations/simulations only.

Tool	Description
Scaling 	Any signal may be scaled provided the conversion is known. When scaling is active, it is indicated with a triangle in the unit button. The true measurement value is shown in the additional info row at the bottom of the sub-window.
Alarm 	Main measurements may be assigned with four alarm limits: high, low, high and low change rate. Active alarms are shown above the main measurement. When an alarm limit is exceeded, a warning signal is heard. A button for acknowledging an alarm appears when needed.
Leak / Stability Test	<p>A leak/stability test may be assigned to main measurements. It tests the leak or stability of, e.g. a pressure measurement system.</p> <p>In the Leak / Stability Test configuration window: Enter Test time and start recording. Use the "+30 sec" button to increase the test time, when needed.</p>

Continues on next page...





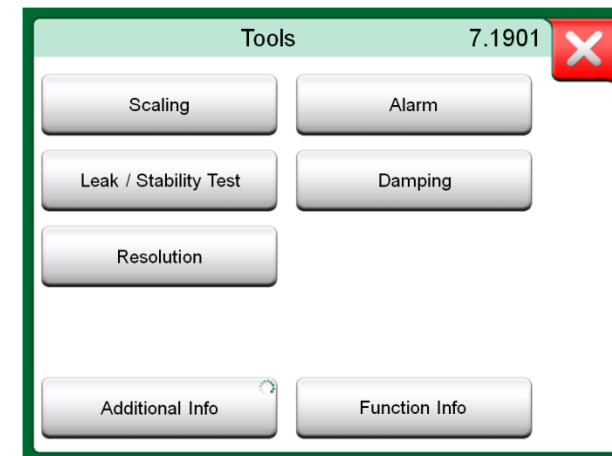



Tools button. See also note below.



Tools available for measurements.

Note.

For practical reasons, the available Tools are limited for Switches.

Tool	Description
Damping 	Use damping when a measurement signal contains unwanted noise. Select one of the available options. When Damping is used, a funnel appears to the left of the main measurement. When damping is active, the following symbol is shown above the unit button:  .
Resolution 	Any signal's resolution may be increased or decreased. Altered resolution is indicated in sub-window, e.g. "-.2" equals two less decimals.
Additional Info 	Including additional information fields at the bottom of a sub-window is always available. The available fields, however, depend on the quantity/settings. Up to four fields may be added to both sub-windows. The additional information row settings are saved for future needs. See also notes to the right.
Function Info	Always available. Opens a pop-up window with information of current function (measurement range, uncertainties etc.).
Step 	Available for generations/simulations: Opens a window for defining a step function for the generated/simulated signal.
Ramp 	Available for generations/simulations: Opens a window for defining a ramp function for the generated/simulated signal.
Quick Access 	Available for generations/simulations: Opens a window for defining five shortcuts to user configurable generation/simulation values. Quick Access buttons appear at the bottom of the sub-window, taking over the space of possible additional info data.

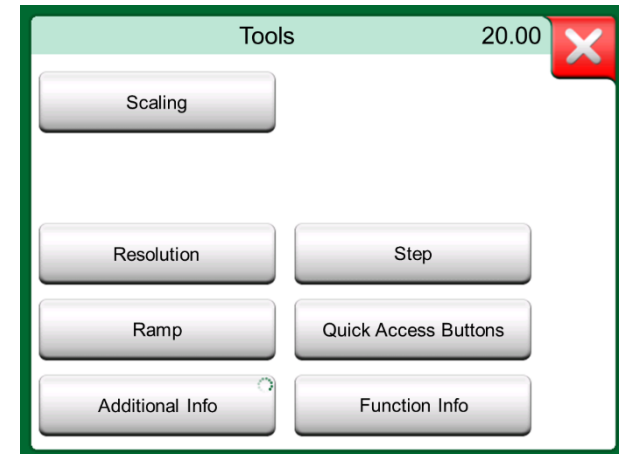

Tools available for generations and simulations.



Quick Access Buttons in use

Notes.

Several Tools have a **"Stop"** button in the pop-up window the Tool is configured in. To stop, e.g. Damping, open the Damping configuration window and tap the "Stop" button. Then MC6 reverts to default damping settings.

Changing the Quantity of a sub-window revert all Tools, except Additional Info settings, to their default settings for that particular Quantity.

In **Calibrator** window: the additional info fields with black text may be zeroed "on the fly". Zeroing options are available in **Additional Info** window's menu.

Some of the tools presented here are also available in **Documenting Calibrator** and **Data Logger**.

Part 5

Things discussed in this part:

- An introduction to calibration
- How to calibrate instruments using MC6's Documenting Calibrator
- How to do a Group Calibration
- How to view calibration results
- How to read instrument data from devices using digital communication

DOCUMENTING CALIBRATOR

GENERAL

MC6's **Documenting Calibrator** is an optional, more advanced tool than the "plain" **Calibrator** that is also available in MC6. If your MC6 does not have this option installed, the **Documenting Calibrator** icon is disabled.

Documenting Calibrator saves instrument data and presents them in a list. Instrument data consists of input and output quantities and ranges as well as other data that defines the instrument. Starting to calibrate an instrument is fast, since all the required data are immediately taken into use.

Instruments to be calibrated may be received from calibration software communicating with MC6. Alternatively, instruments may be created in MC6 itself.

Calibration results are saved and they can be viewed in MC6 and also sent to calibration software for further analysis.

Open **Documenting Calibrator** by tapping on the **Documenting Calibrator** icon in MC6's Home View (see adjacent picture).

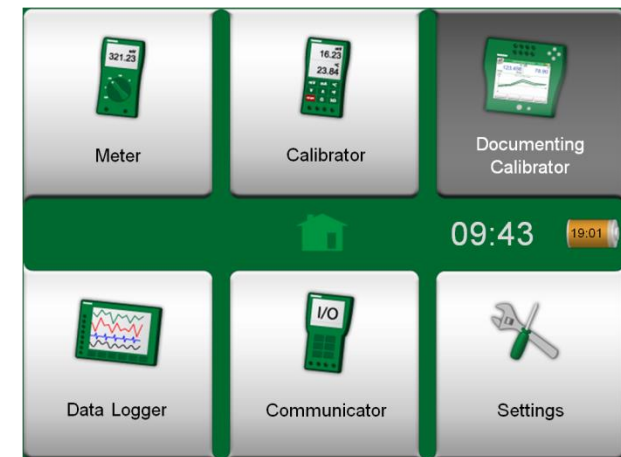

Home View with Documenting Calibrator selected.

CALIBRATION SOFTWARE

When this manual was printed, the following calibration software supported communication with MC6:

- **Beamex CMX Calibration Software**, version 2, revision 2.7 and later versions of CMX Light, Professional and Enterprise editions.
- **Beamex LOGiCAL**, a cloud based tool for handling calibration results.

Note.
Older Beamex calibration software do not support MC6.

CALIBRATING INSTRUMENTS

Instruments are typically calibrated following the procedure shown in the adjacent picture.

In MC6, you first select (or create) the instrument to be calibrated. Then perform the As Found calibration – as many repeats as is required - and decide whether or not adjustment is needed. Often you then do the required amount of As Left repeats to document the instrument's state after the possible adjustment.

A calibration procedure using MC6 is presented in the following pages.

GENERATING/SIMULATING THE INPUT VALUE

How you change the generated/simulated value is explained in **Part 2, Active Terminals and Connections**, chapter **Changing The Generated/Simulated Value**.

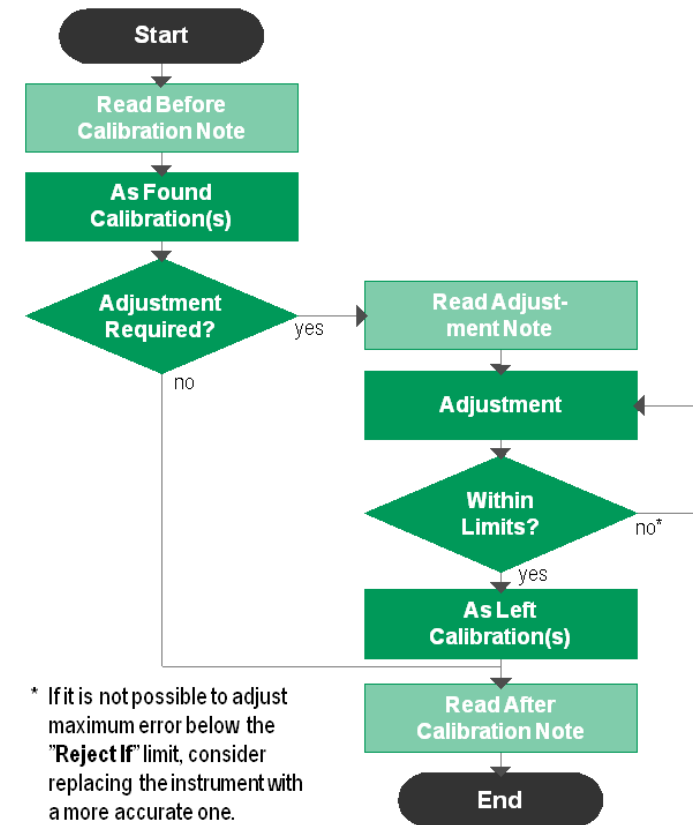

Typical calibration procedure

Note.

Although MC6 assists you in doing the calibration, you need to know how instruments are calibrated; be, e.g. a calibration technician. **MC6 is a tool for calibration professionals.**

INSTRUMENT LIST

When you start the Documenting Calibrator, you arrive in **Instrument List** window. See adjacent picture for an example of an Instrument List.

MC6 allows you to hierarchically organize your instruments into a Plant Structure. The Instrument List window may contain both instruments (gray items) and Plant Structure Levels (yellow items). The following sub chapters present features available in Instrument List window and its menu.

See also **Work Order View Mode** on page 40.

INSTRUMENTS

Instruments have a gray background in the Instrument List window. The instrument's upper text row displays the contents of one of the following fields: **Position ID, Name, Device ID** or **Device Serial Number**. The first non-empty of the aforementioned fields, in presented order, is displayed. The second row displays (possible) Function Name and Calibration Due Date data.

If the instrument has been calibrated, the rightmost end displays an icon. The displayed icon depends on whether the **instrument's** latest calibration "**Passed**", i.e. the found maximum errors were smaller than the instrument's "**Reject If**" error limit, or did it "**Fail**". See pictures to the right.

To **select** an instrument for calibration, tap on it. Then the **Instrument Overview Window**, presented on page 41, opens.

To create a **new instrument**, tap the "Create New Instrument" button. See picture to the right. Then several pages of instrument configuration data opens. Note that by default only basic pages are shown. View all pages by selecting **Show, All Pages** from the menu available when creating/editing an instrument.

To **delete** an instrument, select it and use the delete command available in the menu of opened **Instrument Overview Window**, presented on page 41.

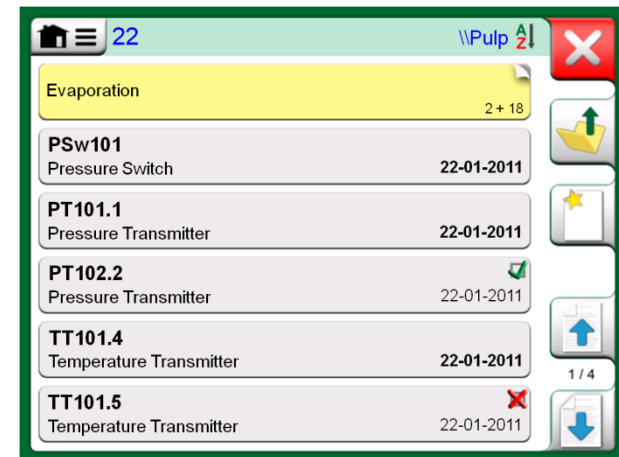

Example of an Instrument List.

Note.

The Instrument List may be several pages long. Remember to use the page browse buttons available on the right side of the window.

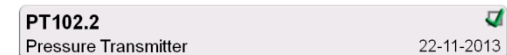

Instrument's latest calibration "Passed"



Instrument's latest calibration "Failed"





"Create New Instrument" button

INSTRUMENT LIST WINDOW MENU

The Instrument List window's menu contains a lot of useful tools:

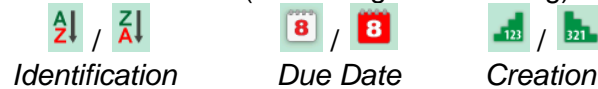
- **Create New** for creating a new Instrument etc. (See adjacent picture.)
- **Sort** for sorting the list contents alphabetically etc.
Sorting icons shown in status bar (ascending / descending):



- **Show** to display all or filter to a selected group of items in the list. The group can be, e.g. all calibrated instruments. When filtering is active, the following icon is shown in the status bar: 
- **View Mode** for defining whether the **Plant Structure** or **Work Order** list is shown.
- **Browse** to jump to start/end of list or finding instruments. When find is in use, the following icon is shown in the status bar: 
- **Manage** for deleting all Instruments/Results/Plant Structure levels and also for moving/renameing Plant Structure levels.

PLANT STRUCTURE LEVELS

The name of the current Plant Structure Level is shown on the status bar. Tap on the bar to see the full Plant Structure path. Plant Structure Sub Levels have yellow background and the upper right corner is folded. The Level's name is displayed and on the lower right corner, the amount of further Sub Levels + the amount of instruments found on the next Sub Level.

To **select** a Plant Structure Level, tap on it. Then the contents of that level are displayed. To **return** to the previous level, tap on the "Back" button found on the right side of the Instrument List window.

Creating and managing **Plant Structure Levels** is presented in chapter **Instrument List Window Menu** above.

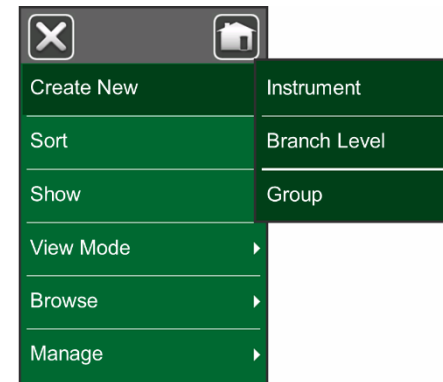

Instrument List Window's menu

Warning!
Once an item is deleted, there is no way to retrieve it.

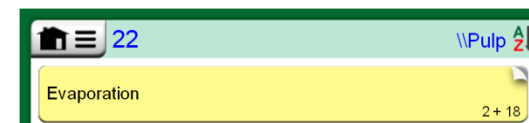

Current Plant Structure Level is called "Pulp".
A total of 22 instruments are located on this Level and all its Sub Levels. Sub Level "Evaporation" has two Sub Levels and 18 instruments.



"Back" button

Notes.
Deleting a branch level also deletes all instruments and calibrations found on that level and all its sub levels.
You cannot delete the structure root level.

WORK ORDER VIEW MODE

Work Order View Mode is an optional way of viewing the instruments. This option is of use, when instruments have been sent from Beamex CMX Calibration Software together with Work Orders in their Calibration Procedure. See adjacent picture on how to activate Work Order View.

If Work Order View is active, a list of Work Orders are shown. Work Orders have green background, the upper right corner is folded and the left side has a blue line. The data in a Work Order are as follows:

- **Work Order Number** in upper left corner.
- **Start Date** and **End Date** below the Work Order Number.
- **Amount of Instruments** included in the Work Order are shown on the lower right corner.

Any instruments not belonging to a Work Order are listed below the Work Orders.

Tapping on a Work Order opens a list of instruments belonging to that Work Order. To indicate that you are in Work Order View Mode, the instruments also have a blue line in their left side. Work Order's Start Date and End Date are presented in Instrument's lower right corner.

When a Work Order is selected, the menu allows you to delete the results of the current Work Order or delete the whole current Work Order.

Calibrating an instrument being part of a Work Order is done exactly as calibrating any other Instrument.

Note.

In **Instrument Overview Window**, presented on page 41, the possible Work Order is shown among Instrument's general data and on a separate page among instrument data. All basic data of Work Orders (Work Order Number and dates) are read only data in MC6.

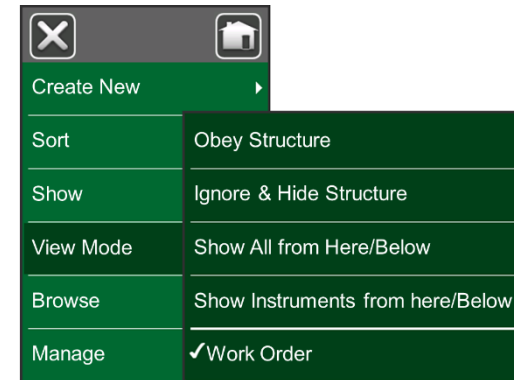

Activating Work Order View Mode.

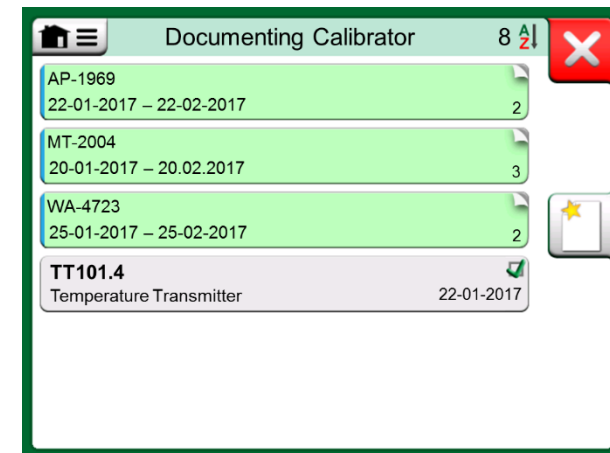

List of Work Orders.



Instrument in Work Order View Mode.

Note.

When Work Order View Mode is active, Plant Structure is not shown and instruments may not be copied or moved within the structure.

INSTRUMENT OVERVIEW WINDOW

When an instrument is selected, the **Instrument Overview** window opens and general data of the selected instrument is presented. See adjacent picture.

With the help of the buttons on the right side of the window, you may

- edit/check the instrument data,
- view calibration results for this instrument (if applicable) or
- start calibrating the selected instrument and open the calibration window (from the check mark on green background).

The bulleted list above is presented in the same order as the icons are in **Instrument Overview** window.

Note that the menu contains some useful instrument related tools.

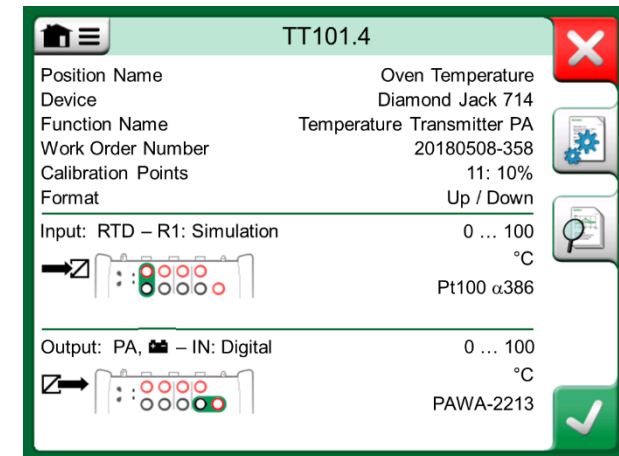

Instrument Overview Window

CALIBRATING AN INSTRUMENT USING MC6

When you start calibrating an instrument, the **Calibration** window opens. See adjacent picture. Note that a possible **Before Calibration Note** window may open before the **Calibration** window is shown.

Before you tap the **Start** button, ensure that the signals are "live", i.e. measurements and the required connections are as they should. If unsure, use the connection diagrams found in the Instrument Overview Window. It opens from the **Info** button.

If gauge pressure modules are used in the calibration, remember to zero them before starting the calibration.

Tap the **Start** button to begin calibration. The rest depends on the instrument setting: **Automatic Acceptance**.

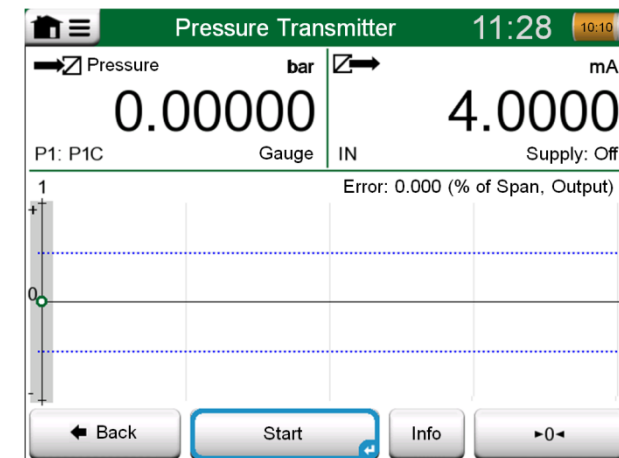

Button for zeroing a pressure module in the lower right corner.

When **Automatic Acceptance** is in use (checked), MC6 accepts calibration point automatically as follows:

1. MC6 uses the **Max. Point Deviation** value to see if the input signal is close enough to the next calibration point.
2. When close enough, MC6 checks the signal stability to decide whether the readings can be saved or not.
3. When signal stability is reached, a timer counts down as set in **Point Delay** and then the readings are saved only if the signal stability is still valid. See hourglass in adjacent picture. If a signal becomes unstable, MC6 returns to phase 2.

Use the **Force Accept** button to manually accept points when, e.g. the calibration does not advance because of an unstable input and/or output signal.

When **Automatic Acceptance** is not in use, every calibration point is manually accepted. Then tap the **Accept Point** button seen in the Calibration window. See lowermost picture to the right.

As the calibration advances, the graph is drawn from point to point. A grey column indicates where next target point is. The width of the grey column is based on **Max. Point Deviation** setting. Numeric values for the next target point can be seen in the lower right corner. If any of the points exceed the error limits (blue dotted lines), the graph is colored red.

The **Pause (||)** button allows you to reject a calibration or undo a point. The button with the "speech bubble" allows you to add notes to each calibration point. For further options, open the menu.

If you need to change the Pressure Module during the calibration, see chapter **Changing the Pressure Module During Calibration** on page 43.

Note.

Certain tools available in **Calibrator** are also available in **Documenting Calibrator**. To see the tools, open **Calibration** window menu, select either **Input** or **Output** and from the opened window, tap on the **Tools** button. The available tools depend on the Quantity and Port selected for the input/output. The same tools are also available when editing the instrument data.

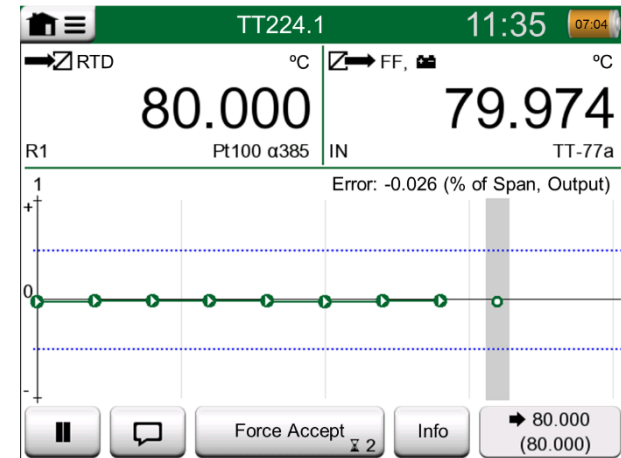

Calibration with Automatic Acceptance in use.

Note.

Opening the menu during calibration pauses the calibration for as long as the menu is open.

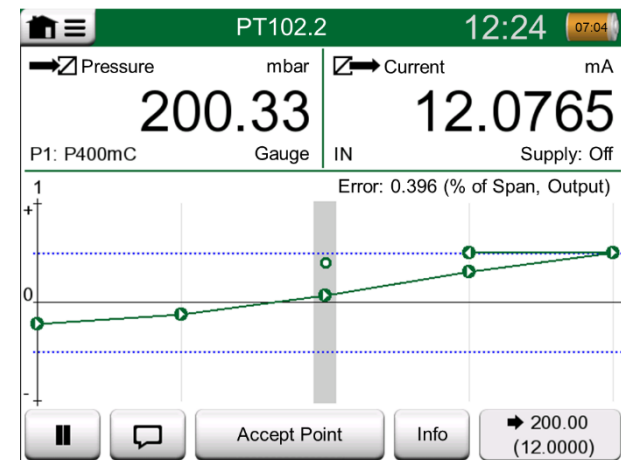

Calibration with manual acceptance.

When the calibration is completed, the first of Calibration Result window's pages open telling you whether the calibration **Passed** or **Failed**. Browse through the pages to get an overview of the calibration results. Note that the amount of pages shown depends on the setting found in the window's menu. To see the basic pages only, open menu and select **Show, Basic Pages**. To see all pages open menu and select **Show, All Pages**.

Save or delete the results using the buttons available on the right side of the window. When saving: In the following window: Tap on the **Combine with Previous Result** check box, if you want to combine the most recent result with previous results. When checked, calibration software treats all combined results as one calibration event containing several repeats.

After saving the results, you are brought back to the **Calibration** window where you may either start another calibration repeat or choose the **Back** button, to end calibration for this instrument.

CHANGING THE PRESSURE MODULE DURING CALIBRATION

If a calibration requires the use of several Pressure Modules, the Pressure Module has to be changed "on the fly". To do it, open **Calibration** window menu, select either **Input** or **Output** (depending on where the Pressure Module is connected). In the opened window:

- If the module to be used is internal or you are changing from an Internal Pressure Module to an already connected External Pressure Module, just tap the button below **Port/Function** text and select it from the available Pressure Modules.
- If you want to change the External Pressure module in use to another External Pressure Module connectable to the same port as the one currently in use, tap on the button seen in the adjacent picture. Continue with the change as explained on MC6's display.

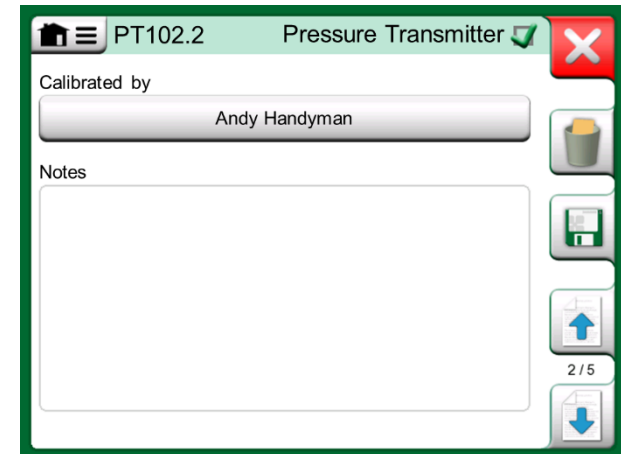

Calibration results page for entering calibrating technician's name, and possible notes.

Input [mbar]	Output [mA]	Error [% of Span]	Significance [%]
0.00	3.9650	-0.2191	43.8
50.00	5.9725	-0.172	34.4
100.00	7.9800	-0.125	25.0
150.00	9.9950	-0.031	6.2
200.00	12.0100	0.062	12.5
250.00	14.0300	0.188	37.5
300.00	16.0500	0.313	62.5
350.00	18.0600	0.375	75.0
400.00	20.0700	0.438	87.5

Numeric calibration results page. For results including more than nine calibration points, use the scroll buttons or scroll bar to view hidden data.

ABOUT FIELDBUS AND HART DEVICE SPECIFICS

Detailed information of fieldbus and HART device specifics are discussed in **Part 7, Communicator**. However, here are some hints on where fieldbus and HART device related features appear in Documenting Calibrator.

Adding fieldbus and HART Instrument to MC6's database

When adding a fieldbus instrument or a HART instrument's digital output to MC6's database, select **HART**, **FOUNDATION Fieldbus H1** or **Profibus PA** as the output quantity. See adjacent picture and note below.

See also chapter **Digital Communication and MC6's Instrument Data** on page 49.

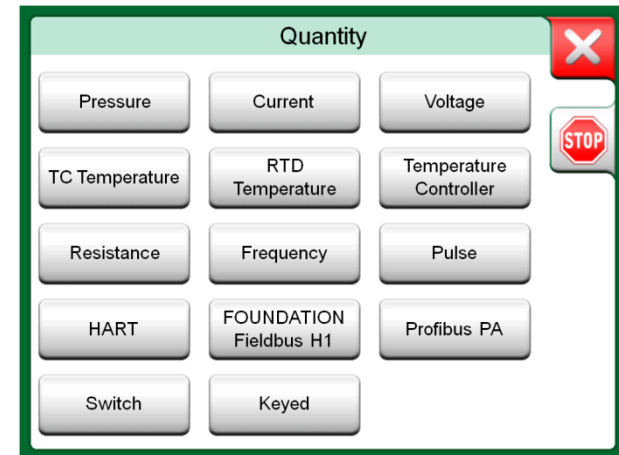

Documenting Calibrator's quantity selection window

Note.

For HART instrument's **analog output**, select **Current** as the output quantity.

Additional utilities during calibration

During Calibration, MC6's menu has additional menu options available: For both HART and fieldbus instruments: a possibility to invoke the communicator to edit instrument data and when needed, start a HART trim method. For fieldbus instruments, an additional menu option for trimming the instrument is also available.

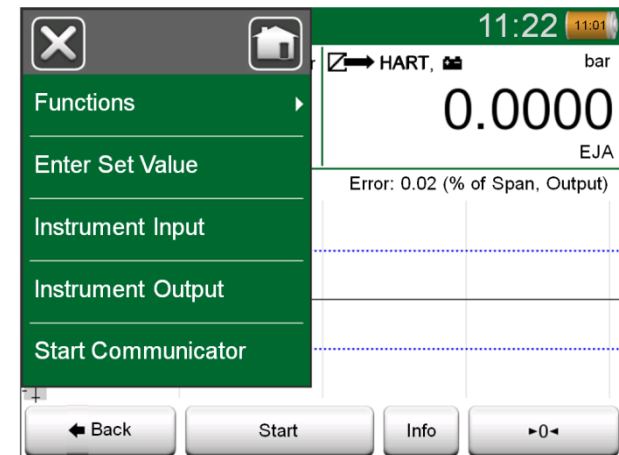

Menu in Documenting Calibrator when calibrating a HART instrument.

GROUP CALIBRATION

MC6's **Group Calibration** allows you to simultaneously calibrate several Instruments/Functions. This is practical, e.g. when calibrating Instruments/Functions that are part of a loop, or when input generation takes time (temperature) and there are several devices to be calibrated.

Note.
Switches are not supported in group calibration. All other type of instruments/functions can be included in a group.

COLLECTING INSTRUMENTS/FUNCTIONS FOR GROUP CALIBRATION

To start collecting Instruments/Functions to a group, open the **Documenting Calibrator's Instrument List** window: Open the menu and tap on **Create New** to see the sub-menu where Grouping can be activated. See adjacent picture.

Collect Instruments/Functions by tapping on each Instrument/Function you want to add to the group. In the **Instrument Overview** window, tap on the **Add to Group** button to add another instrument to the group. See picture below. The Hardware Focus Indicator is on the **Add to Group** button.

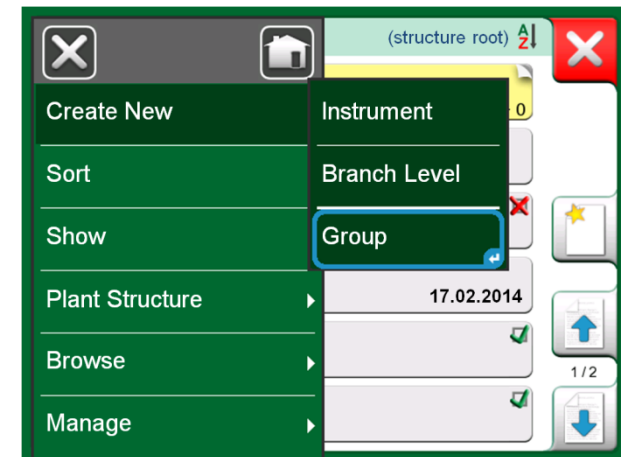

Activating a Group.

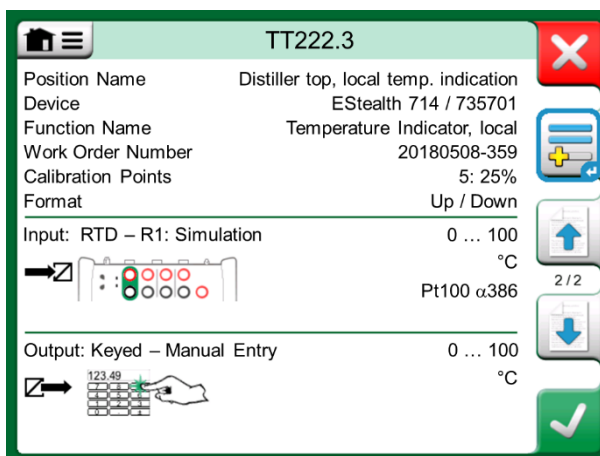

Hardware Focus Indicator on "Add to Group" button.



Instruments/Functions selected in a group have blue background in the Instrument List.

EDITING A GROUP

By default, the Instruments/Functions are calibrated in the order they were included in the group. However, the **Instrument Overview** window's menu includes a possibility to sort the group according to your own needs. The same menu also includes a possibility to cancel the Group or to remove the current Instrument/Function from the Group (in the **Instrument** menu option's sub-menu).

Menu item **Instrument Order, Optimize** sorts the items automatically so the first instrument to be calibrated has the smallest/lowest calibration point of all instruments in the group.

Notes.

The **Instrument Overview** window's buttons change when Group Calibration is active. In addition to **Add to Group** button you have browse buttons for browsing through the Instruments/Functions selected to the Group. **Instrument Settings** and **Calibration Results** are moved to the **Instrument Overview** window's menu.

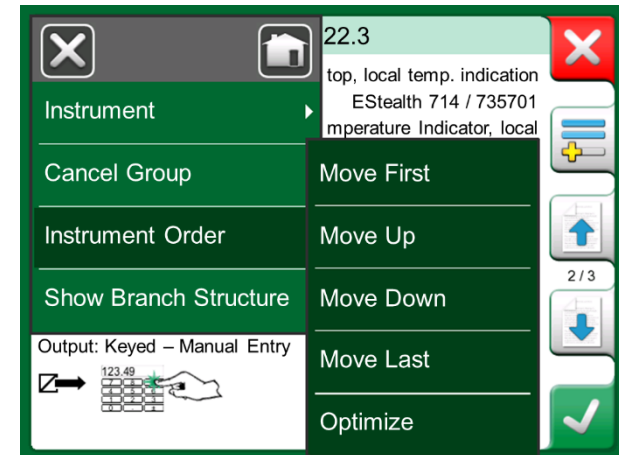

Sorting the Instruments/Functions in a group.

CALIBRATING A GROUP

Calibration is started the same way as the calibration of a single Instrument/Function; by tapping the **Instrument Overview** window's **Accept** button. The **Calibration** window opens displaying the Group's first Instrument/Function.

The text in the **Calibration** window's **Info** button has changed to indicate which Instrument/Function is currently shown in the window (**1/3** in the adjacent picture). The functionality of the button is the same:

Before starting, check the settings in the **Calibration** window's menu: **Settings** include the possibility to show the **Function Name** in the Title Bar. It may be a more descriptive text when calibrating a group of Instruments/Functions belonging to a loop.

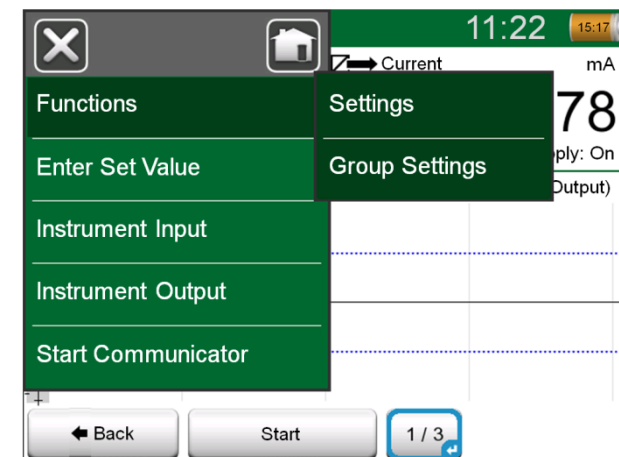

Settings and Group Settings

GROUP SETTINGS

In **Group Settings** you can define two things:

- **Calibration Point Sequence**, i.e. how the calibration points are run through. More details below.
- When the **Instrument Overview** (Instrument Info) window appears during Group Calibration.

Calibration Point Sequence options:

- **By Group**: Suitable when all instruments selected into the group have the same input span. The instruments may have different amount of calibration points as long as the input span is the same.
- **By Value**: The instruments selected into the group may have a span of any size. The only important thing is: **The group's first instrument has to have the smallest/lowest calibration point of all instruments in the group**. When necessary, use the sorting tool presented in chapter **Editing a Group** on page 46.

PERFORMING THE CALIBRATION

The actual calibration is done from point to point similarly as a non-Group Calibration. You may change the default calibration order of Instruments/Functions by tapping the Info button (see adjacent picture) and selecting another Instrument/Function by browsing the Instrument Overview window.

After all points of all Instruments/Functions are done, the calibration result pages open one by one and you have the chance to save (or not) the calibration results for each Instrument/Function in the Group.

When the results of all Instruments/Functions are saved (or not), MC6 returns to the **Calibration** window. Now you may do another calibration run or return to the instrument list to, e.g. remove Instruments/Functions from the Group that did pass in the As Found test and leave the Instruments/Functions in the Group that require As Left calibration.

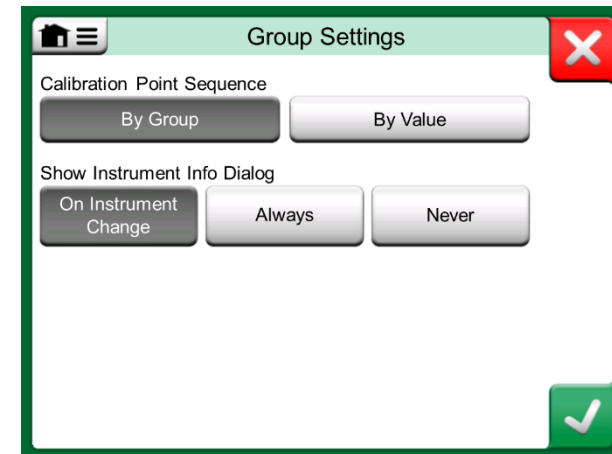

Group Settings Window.

Note.

Remember to change connections (if necessary) when the Instrument/Function changes during the Group calibration.

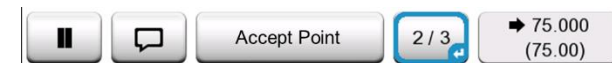

*Info button highlighted.
(2nd instrument of a group of three @ 75 °C)*

Hint.

Examples of Instruments/Functions suited for Group Calibration:

- A measurement loop, including a temperature transmitter, a local temperature indicator and a temperature indicator in the control room.
- A set of temperature sensors calibrated simultaneously using, e.g. a dry block.

CALIBRATION RESULTS

Once an instrument has been calibrated, you may view saved calibration results as follows:

- When viewing the **Instrument Overview Window**, select the **Calibration Results** button.

The most recent saved calibration is presented. If you want to see older results, open the menu in **Calibration Results** window and select **Results History**. Then a list presenting all saved results opens. See adjacent picture.

To separate calibration events from each other, they have a different shades of gray background colors. If the instrument's settings have changed, a field with blue background is seen. Tap it to see the settings as they were before that date/time.

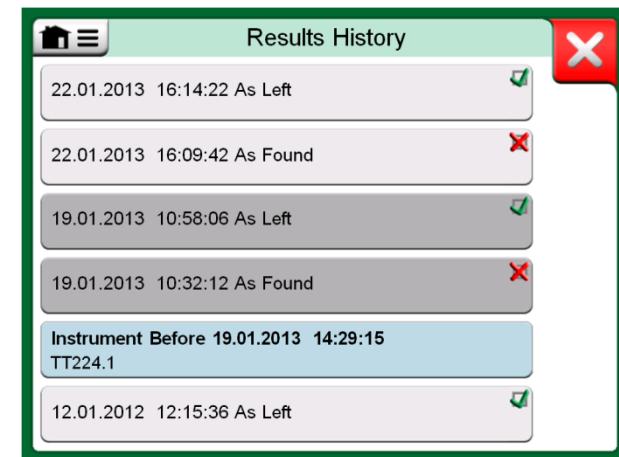

Calibration results history window

Note.
Saved calibration results cannot be edited.

DELETING CALIBRATION RESULTS

When viewing the results of a calibration, you may delete the currently viewed result (menu option **Delete This Result**) or remove all results related to current instrument (menu option **Delete All Results**).

You may also remove all results related to current instrument in **Results History** window: Select menu option **Delete All Results**.

Warning!
Once the results are deleted, there is no way to retrieve them.

DIGITAL COMMUNICATION AND MC6's INSTRUMENT DATA

With this feature, you may add instrument data to MC6 from Instruments using Digital Communication:

- **HART®** instruments,
- **FOUNDATION Fieldbus H1™** instruments and
- **PROFIBUS PA™** Instruments

All you need is connect the instrument to MC6, select a communication protocol and receive data of the Instrument using Digital Communication to MC6's Instrument Data. No error prone manual entry of Instrument Data.

MC6 has pre-entered default mappings (which Digital Communication Instrument field goes to which field in MC6) but you may customize the mapping for each instrument model you use.

Notes.

Utilizing this feature requires that your MC6 has the Documenting Calibrator option as well as the option to communicate with the smart instrument type (Fieldbus option) you want to add to MC6's instrument data.

You may easily populate CMX's Instrument database by first mapping instrument data to MC6 and then transferring the instruments to CMX.

More of Instrument's utilizing Digital Communication can be found in Part 7 of this manual.

GETTING AND EDITING MAPPED DATA

PREPARATIONS

The data mapping can be done to a new instrument or to an existing instrument in MC6. The Instrument's Output has to be one of the following:

- Current (measurement),
- HART®,
- FOUNDATION Fieldbus H1™ or
- Profibus PA™.

Note.

With Current Measurement as the Instrument's Output, the communication is available for the HART transmitter found in address 0 only.

GETTING DEFAULT MAPPINGS

On any of the instrument data pages, open the menu and tap **Get Mapped Values**. Then MC6 starts reading data from the connected instrument to MC6's Identification and Device fields, according to **Mapping** settings.

That's all you need to do, provided the mappings suit your needs. If not, see chapter **Customizing the Mappings** below.

However, you should anyhow always check all the instrument settings after the data is read, before continuing with your work.

Note.

For HART® Instrument's, the input setting is also read from the transmitter. For other instruments, you need to manually add the Instrument's input data.

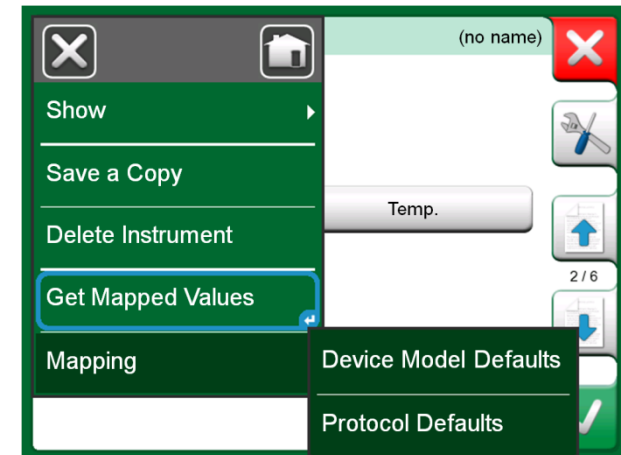

Mapping menus on instrument pages.

CUSTOMIZING THE MAPPINGS

The menu option, **Mapping**, has in its submenus options on how to define general mappings on protocol level (**HART**, **FOUNDATION Fieldbus H1** or **Profibus PA**) and also default mappings on device model level.

MC6 uses the **Protocol Defaults** if no default mappings are defined for the connected device model. If **Device Model Defaults** exist for the connected device model, they are used instead of **Protocol Defaults**.

In the adjacent picture you can see a sample of the mappings. The left side lists the fields in MC6 (target fields) and the Mapping Mode of the field (Generic in all cases of the sample picture). The right side lists the value and name of the field in the device.

Tap on one of the buttons to edit the mapping. You may also add new mappings using the **New** button, the button with blank sheet and a star on its upper right corner. New mappings are defined similarly as existing mappings are edited.

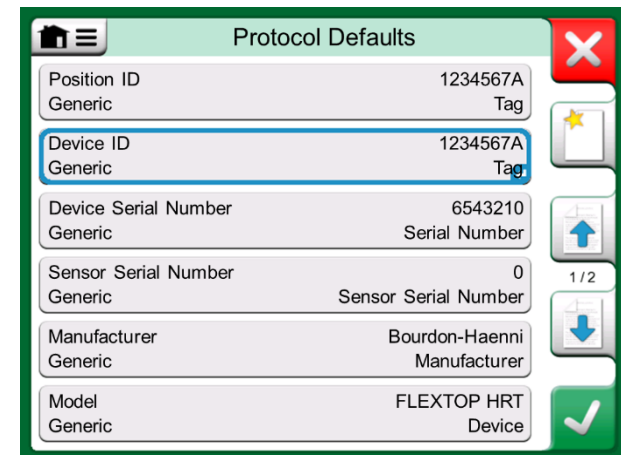

Sample of default mappings for HART protocol.

Creating a new mapping or editing an existing mapping is done in a window like the one to the right.

Target Field is the field in MC6, **Value** is the field and its value in the connected device. Mapping Mode defines how the mapping is done.

- **Generic**, gives you a list of protocol's common fields.
- **Text**, assigns a fixed text to the selected MC6 field.
- **DD Field**, gives you a list of all fields etc. available in the device model's Device Description. Note that this option is not available for the **Protocol Defaults**, only for **Device Model Defaults**.

Notes.

It is possible to map the same transmitter field into several MC6 fields. In the picture on previous page, device's **Tag** is mapped both to **Position ID** and **Device ID** in MC6's instrument data.

When adding or editing mapping, the target fields that are already being used are disabled (gray).

When you change the mapping, it will be saved as the default mapping for future use.

After changing the mapping, you need to read the data again using the **Get Mapped Data** menu command.

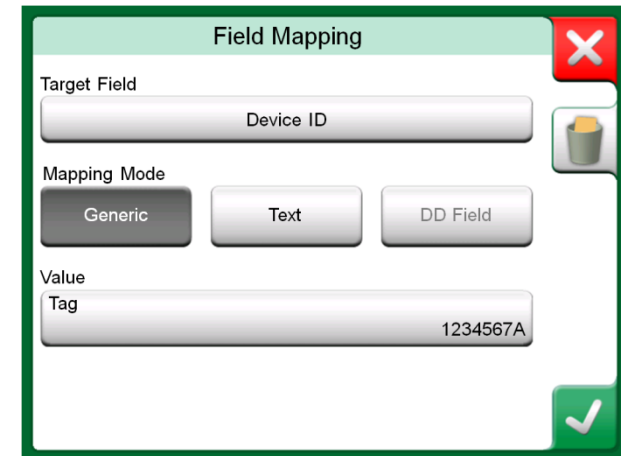

Sample of default mappings for HART protocol.

Note.

You can remove a single mapping line by opening it and touching the "Trash Can" icon.

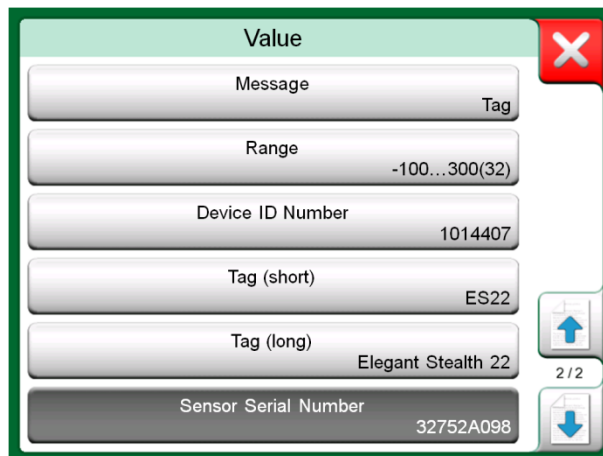

Generic Fields when Mapping Mode is "Generic".

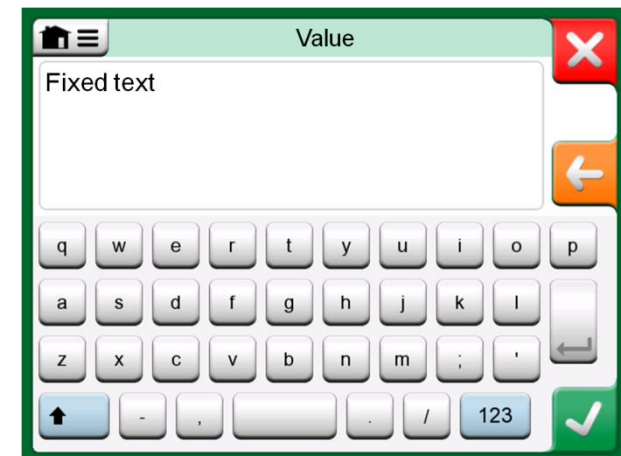

Text editing when Mapping Mode is "Text".

Part 6

Things discussed in this part:

- An introduction Data Logger option and its capabilities.
- How to configure and start a Data Log.
- How to view, save and delete Data Log results.
- How to transfer Data Log results to a personal computer (PC).

DATA LOGGER

GENERAL

The **Data Logger** is an optional tool that allows you to collect data with MC6. If the Data Logger option is purchased, the collected data may then be viewed, transferred to a personal computer (PC) and printed using a utility called **Beamex MC6 Data Log Viewer**. It is shipped together with MC6.

If your MC6 does not have the option installed, the **Data Logger** icon in MC6's Home View is disabled.

If applicable, open the main configuration window of the Data Logger by tapping on the **Data Logger** icon in MC6's Home View (see adjacent picture).

Data Logger supports logging up to nine measurement/generation/simulation channels at the same time. However, the amount of available measurements/generations/simulations depends on how your MC6 is equipped.

The window on this page's lower right corner is the **Data Logger's** main configuration window when no data log channels have been configured. Typically, you see some previously configured channels, since MC6 remembers the latest data log configurations.

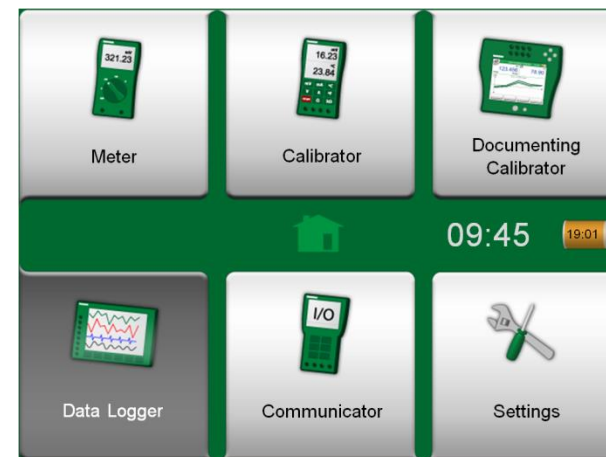

Home View with Data Logger selected

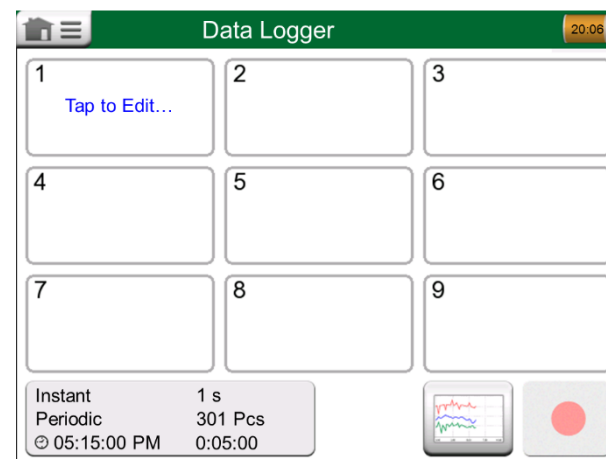

Main configuration window

DOING A DATA LOG

CONFIGURING

In the main configuration window: Tap on one of the numbered areas to configure a channel.

Each channel have individual configuration pages as follows:

- A page for defining the measured/generated/simulated quantity and its additional settings.
- Another for defining the range of the graph, giving the measurement/generation/simulation a descriptive name (optional) and selecting plot color.
- A third page is available for measurement channels only: You may define a trigger that invokes the Data Log. When triggering is configured, a symbol indicates it. See channel three in the adjacent picture.

Remember to check/edit the general settings of your Data Log. Tap on the area in the lower left corner of Data Logger's main configuration window. There you may, among other things, define how the logging is performed, what value is saved and the duration of the logging.

SAVING AND OPENING CONFIGURATIONS

In addition to MC6 remembering the latest Data Log configurations, you may save useful configurations for future use. Saving and opening previously saved configurations is available in the menu of Data Logger's main configuration window.

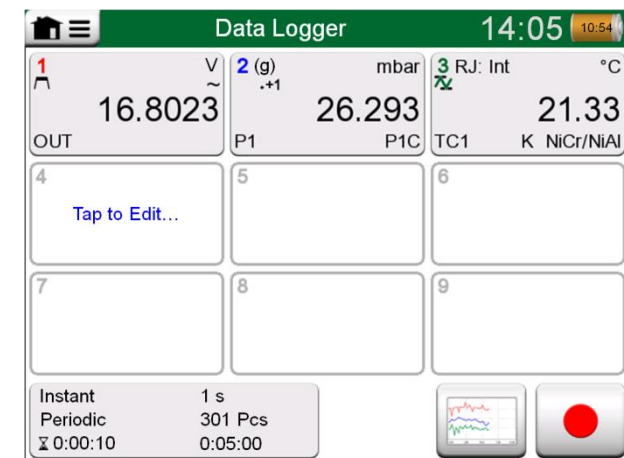

Three configured channels in main configuration window.

Note.

For pressure measurements:

The main configuration window's menu includes a possibility to zero gauge pressure modules. Zeroing is also possible in channel setup windows (when applicable).

STARTING THE DATA LOG

Start the Data Log by tapping on the red **"Record"** button in the main configuration window's lower right corner. The button changes to a black **"Stop"** button allowing you to interrupt you Data Log, when necessary.

The actual start of Data Logging depend on general settings as follows:

- If you have defined a delay in the **Delayed Start** field, an hour glass with a down counter appears for as long as the delay requires. The delay may be either a defined wait time, e.g. 5 minutes, or a specific time of the day, e.g. 5:15 PM.
- If your **Logging Method** is **"Key Press"**, a camera button appears for you to take "snap shots" of the measurements.

When the possible delay defined in general settings has expired, possible triggers defined for individual channels delay the start of the Data Logging. Any channel that triggers, starts the Data Log. See also note below.

You may change the view from the main configuration window to the graph view (lower picture on this page) and back using the button to the left of the Record/Stop button.

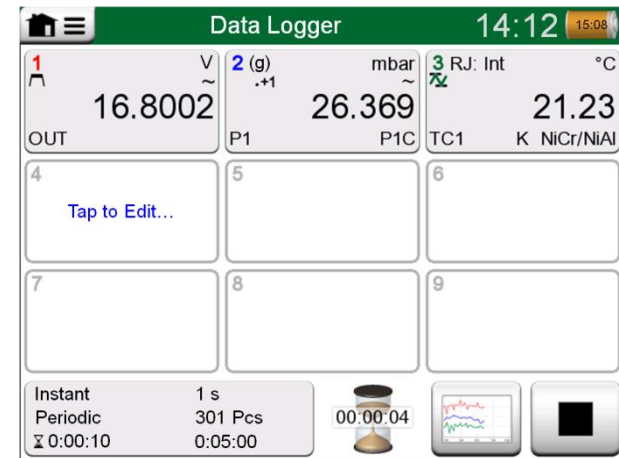

Counting down the delay

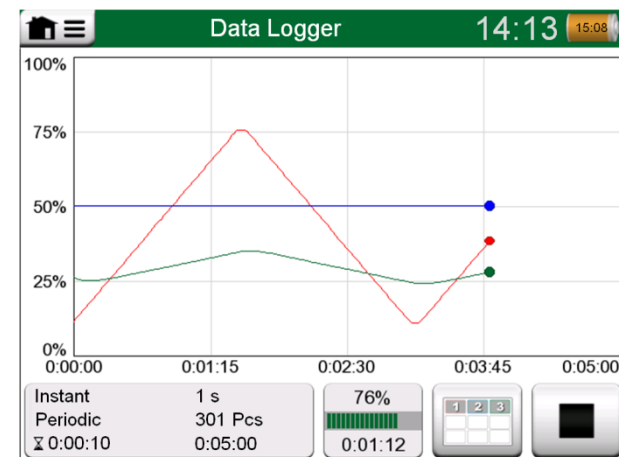

Graph view during Data Log.



Snap shot button

Notes.

If, in general settings, the **Logging Method** is **"Key Press"**, none of possible triggers defined for individual channels are valid. The snap shot is saved immediately each time the snap shot button is tapped on.

A generation/simulation value may be changed during the data log as follows:

In the main configuration window, tap on the channel where a generation/simulation is configured. In the opened window, locate the output value field and tap on it to edit the numeric value.

VIEWING AND SAVING OR DELETING THE RESULTS

When Data Logging is finished, or stopped, the results are shown on three pages: general information page, graph page and a table of numeric results. If the table of numeric results is large, use the scroll buttons or the scroll bar to see hidden rows/columns.

All pages include a possibility to either save or delete the Data Logging results.

When saving, you have the possibility to give a descriptive name to the Data Logging results. MC6 automatically adds date and time to the Data Logging results.

Results Preview			
Time	OUT (V)	P1 (mbar)	TC1 (°C)
25.11.2013 14:14:12	Instant	Instant	Instant
14:14:58	9.19420~	26.295	187.97~
14:14:59	9.32233~	26.295	189.54~
14:15:00	9.57961~	26.294	190.83~
14:15:01	9.77181~	26.295	192.66~
14:15:02	9.96403~	26.297	194.09~
14:15:03	10.1562~	26.294	195.65~
14:15:04	10.3484~	26.295	197.16~
14:15:05	10.5406~	26.295	198.84~
14:15:06	10.7328~	26.295	200.57~

Results Preview

VIEWING SAVED DATA LOG RESULTS

If you have saved Data Logs, they may be viewed as follows:

- From the menu of the Data Logging's main configuration window. Select menu option **View Data Log Results**.

Each saved Data Log result has the time/date it was saved and the entered result name on the first row in bold font. On the second row you can see information of Data Log's size and possibly the name of the configuration used for doing the Data Log.

Note.

When viewing the list of saved Data Log results, the menu includes the possibility to **Delete All** saved Data Log results. If you select one of the existing results for viewing, the menu includes a possibility to either **Delete** or **Rename** the viewed Data Log results.

Data Log Results	
22-02-2011 15:01:51 61 rows 1.06 kB	Just Testing 2 Signal Test Configuration
07-02-2011 09:12:22 1201 rows 18.7 kB	No Smoke Without Fire Temp. Measurement config.
29-01-2011 13:55:21 301 rows 14.0 kB	Blowin' Free Available press. modules config.
25-01-2011 15:02:35 43201 rows 674 kB	Argus All 9 channels in use config.
24-01-2011 10:23:15 22156 rows 345 kB	Elegant Stealth Signal disturbance search
22-01-2011 18:15:00 61 rows 1.06 kB	Just Testing Signal Test Configuration

Data Log Result list.

TRANSFERRING DATA LOG RESULTS TO A PERSONAL COMPUTER

Beamex MC6 Data Log Viewer (executable file: "MC6DataLogViewer.exe") reads data log results to a Personal Computer. The software works in any 32 bit or 64 bit Windows® 7 ... Windows® 10 operating system. Installation software for Beamex MC6 Data Log Viewer is downloadable from Beamex's web site <https://www.beamex.com>. Look for **Download Center**.

Before you read data from MC6, you must connect MC6 to your PC using the USB cable provided. Then install the driver as presented in **Part 1, Introduction**, chapter **USB Communication Driver**.

After the driver is installed, the software can be used for downloading the results from MC6 and viewing the results. The data can be saved in viewer's native format (.LG6) or saved as **CSV** files. The latter format can easily be imported into spreadsheet software.

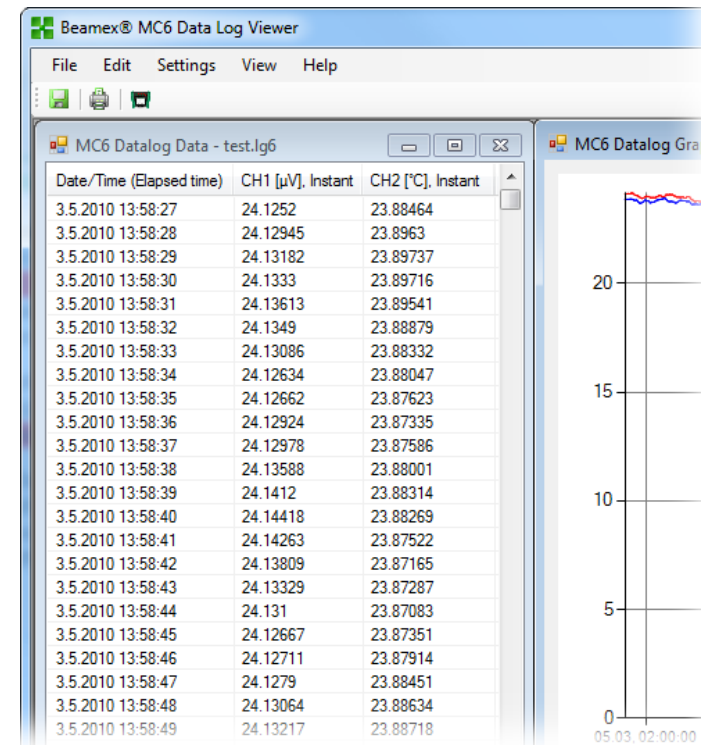

Screen shot of Beamex MC6 Data Log Viewer

Part 7

Things discussed in this part:

- An introduction MC6's Communicator and how it can be started.
- How to connect to an instrument capable of digital communication.
- Instructions on how to quickly select a variable/parameter for use in Calibrator, Documenting Calibrator or Data Logger.
- How to edit instrument parameters.
- About how to trim a Fieldbus/HART instrument.

COMMUNICATOR

GENERAL

MC6's **Communicator** option allows you to connect to the following Instruments utilizing Digital Communication:

- **HART®** instruments^(*)
(<https://www.fieldcommgroup.org/>)
MC6 can be used as a primary or secondary master of a segment.
- **FOUNDATION Fieldbus H1™** instruments
(<http://www.fieldbus.org/>).
MC6 is seen as a guest device (visitor) and, when necessary, as a Link Active Scheduler (LAS, segment's master device).
- **PROFIBUS PA™** Instruments
(<https://www.profibus.com/>).
MC6 takes the role of PROFIBUS Master when connected to a PROFIBUS segment.

When **Communicator** is started, a list of communication protocols available for MC6 is shown. See lower picture to the right.

Notes.

Each communication protocol is a separate option in MC6, so all protocols are not necessary enabled in your MC6.

This manual is not an introduction to HART and Fieldbus instruments. Get the know-how and terminology from books dedicated to HART and Fieldbus instruments and technology.

The Communicator's user interface may include text in another language than what MC6's user interface language setting is. This happens when the language of the instrument's fields etc. differ from MC6's.

^{*)} MC6 supports HART instruments using HART Protocols 5, 6 and 7.

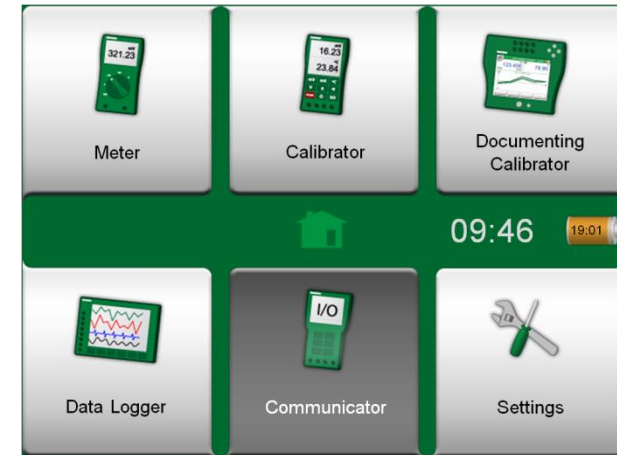

Home View with Communicator selected

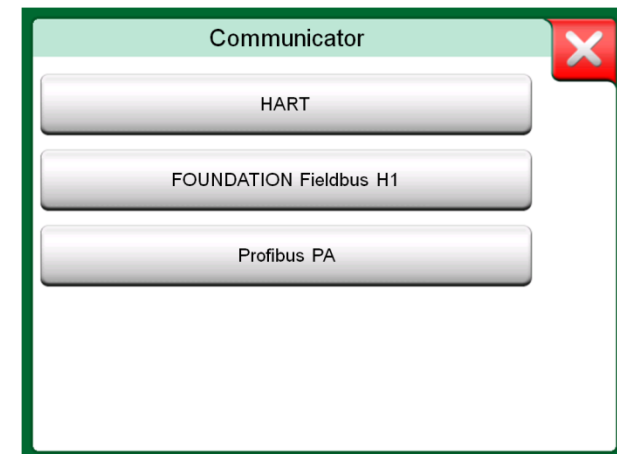

Communication protocols.

Communication may also be started from the following main functions in MC6:

- **Calibrator**,
- **Documenting Calibrator** and
- **Data Logger**.

Depending on active/inactive options, some communication protocols may be disabled (grayed).

MC6's **Communicator** is primarily meant for viewing and editing the configuration of Digital Communication Instruments. However, when invoking communication from **Calibrator**, **Documenting Calibrator** or **Data Logger**, you most likely plan to **select a Variable or Parameter** (e.g. Primary Value) for calibration or data logging instead of doing full configuration for the instrument. MC6, of course, supports this functionality too.

See also **HART Device Description Specifics** on page 69.

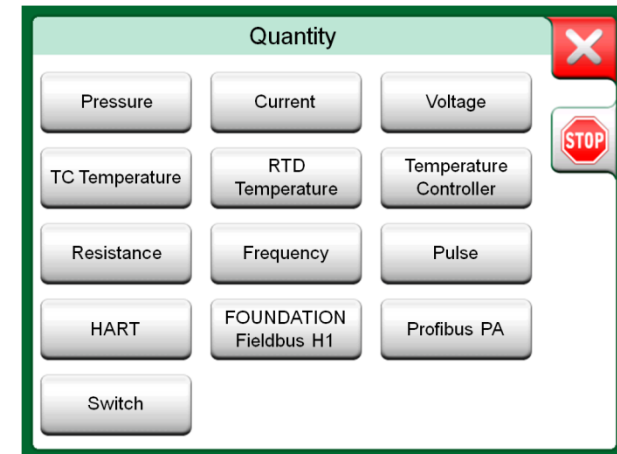

*Selecting a communication protocol in **Calibrator**, **Documenting Calibrator** and **Data Logger**.*

WARNINGS

Configuring/calibrating an instrument that is part of a live segment is possible in HART and FOUNDATION Fieldbus only. When working in a live segment, first make sure, the control loop the instrument is part of is set to manual. Follow the guidelines available in the instrument's own manual.

Beamex cannot be held responsible for any damages caused by connecting MC6 to a live factory fieldbus segment.

Using MC6 to change the parameters of an instrument may result in discrepancies: A fieldbus host control system may mirror all instrument parameters in its permanent database. In such a case, when returning an instrument with changed parameters to a live segment, ensure that the parameters are also available in the control system's permanent database. Also verify that the new parameters do not result in an unstable control loop.

CONNECTIONS

When communicating with Digital Communication Instruments, the connection differs depending on whether MC6's internal power supply is used or not.

The upper picture to the right presents the connections when **MC6's internal power supply is used**. MC6's power supply can safely provide supply power to a single instrument. If connecting to a HART/fieldbus segment containing several instruments, consider using an external power supply as presented further on.

The lower picture to the right presents the connections when **an external power supply is used**. Then, to ensure communication, there may be need to include an external resistor (250 ohm for HART and 50 ohm for fieldbuses). However, when using a fieldbus compliant power supply, there is no need for an external resistor. See also warning below.

Notes.

The connection between MC6 and the instrument/fieldbus may be done using pair of standard measurement cables. However, when using longer connecting cables there may be need for fieldbus terminators.

Warning!

When working in PROFIBUS PA: Do not connect two master devices (e.g. MC6, a Field Communicator or a control system) at the same time to the same segment! They clash and make the fieldbus segment unstable. Remove the instrument to be calibrated from the live segment for calibration.

See also **Warnings** on page 61.

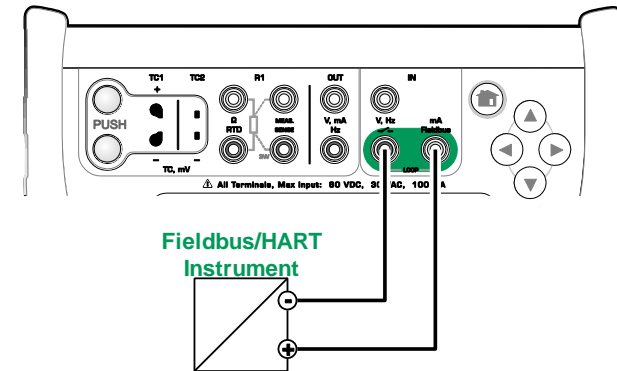

Using MC6's internal power supply.

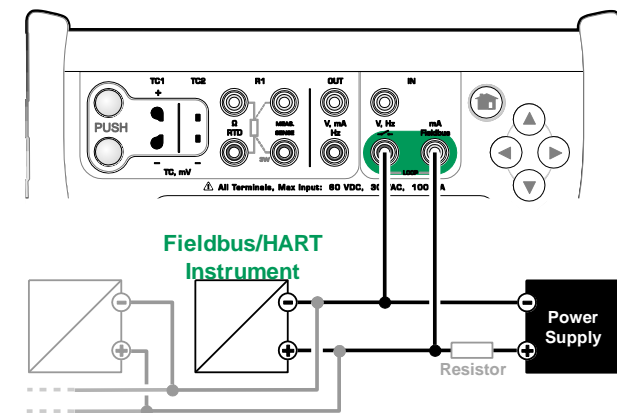

Using an external power supply.

SELECTING THE INSTRUMENT

When a communication protocol is selected, a window opens for choosing **whether MC6's internal 24 V supply is used or not**. When using an external supply, ensure communication by using either a Fieldbus/HART compliant power supply or add a suitable resistor between the power supply and the fieldbus. See chapter **Connections** on page 62 and consult your power supply's manual.

There is also a button for editing/checking the **Protocol Settings**. The default settings should apply, so do not make changes unless you are sure. Consult the fieldbus instrument's manual, in case of communication problems.

See also **HART Device Description Specifics** on page 69.

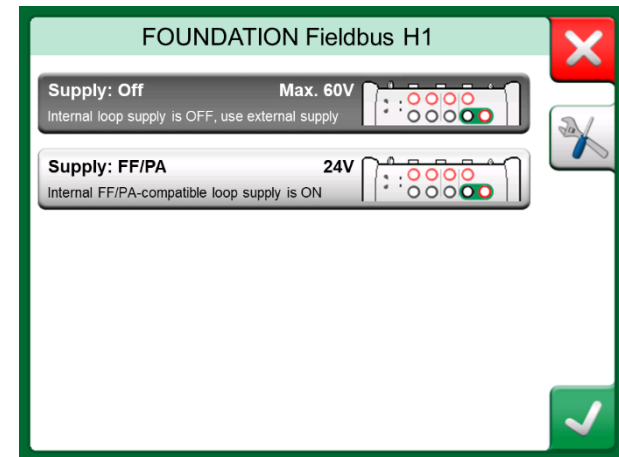

Supply voltage setting

LIST OF FOUND DEVICES

When continuing, MC6 searches (monitors) for connected instruments and a window with a list of found devices opens. The window also includes a "refresh" button (two "rotating arrows") to retry the search for connected instruments. The button with the cogwheels allows you to quickly edit the tag and address for the listed instruments. When edit mode is on, the button backgrounds change to blue.

When not editing tag and address, select the instrument for calibration by tapping on its name in the displayed list. Then MC6 uploads the instrument's data into its memory and when ready, displays it.

Note.

If MC6 does not have the Device Description file for the selected instrument, a window opens informing you of the situation. Look for new Device Description files at Beamex's web site: <https://www.beamex.com>. Install a downloaded Device Description file using the Device Description Installer software available at Beamex's web site: <https://www.beamex.com>. Look for **Download Center**.

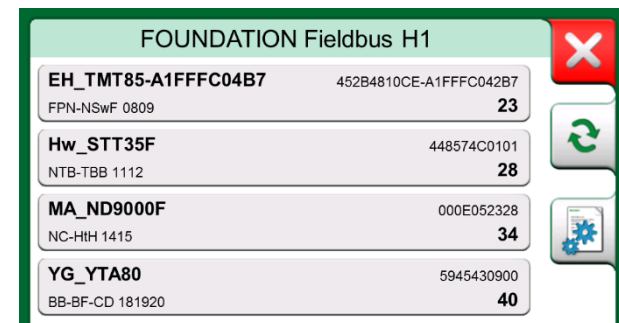

A list of found devices.

IMPORTANT!

When the calibrator is monitoring a fieldbus/HART segment, **DO NOT** disconnect/reconnect the calibrator to/from the segment. The segment may become unstable.

ABOUT INSTRUMENT PARAMETERS

INSTRUMENT PARAMETERS IN GENERAL

This chapter briefly presents how **Blocks**, **Records** and **Parameters** of Digital Communication Instruments are viewed in MC6 and how you may browse through them. Elements seen while viewing/configuring an instrument:

- **Blocks** and **Records** have yellow background where the upper right corner is folded. They may contain sub-blocks, sub-records, editable parameters and read-only parameters. Tap on the block/record to see its contents.
- Different types of **Parameters**:
 - **Editable Parameters** have gray background. They may be numeric, text, single select, multi select or date fields. Tap to edit the field data.
 - **Read-Only Parameters** are data that you may view/read but they cannot be edited. They have gray background with a "lock" in the upper right corner.
 - **Value Parameter** is actually a special case of the Read-Only Parameter. The value is a result of a measurement and cannot be edited, but it can be opened for viewing and selected for use in the **Calibrator**, **Documenting Calibrator** or **Data Logger**. Value Parameters have green background. See also note to the right and hint below.
 - **Methods** look like parameters, but are actually automated procedures for e.g. calibration in HART instruments. For details, see instrument's user manual.

Hint.

Since value parameters are often of high interest, the menu contains a possibility to view value parameters (measurable variables) only.

See also **HART Device Description Specifics** on page 69.

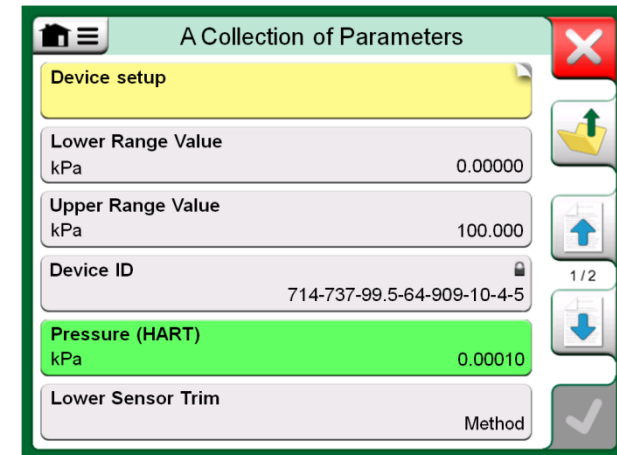

Blocks and Parameters, an example view.

Notes.

If you select a Value Parameter and you started communication from the **Communicator**, the value is taken into use in **Calibrator**. If communication is started from any other supported main function, e.g. **Data Logger**, the chosen Value Parameter is taken into use in that particular main function.

CALIBRATING OR DATA LOGGING HART INSTRUMENTS

Usually, when calibrating or logging, you need to locate a **Value Parameter**, a Process Variable, in the HART instrument's instrument data. Remember that Value Parameters have green background.

Unfortunately the structure of data and naming conventions in HART instruments vary between different makes and models. Thus there is no single path from selecting the instrument in MC6 to locating the parameter. Refer to your instrument's manual to find the blocks where the parameters are located. Use the information presented on the previous page to browse the instrument data. See also hint on previous page.

Once the parameter is located, tap on it. In the opened window (a picture similar to the one at bottom right): Tap the **Accept** button to start calibrating or logging that parameter.

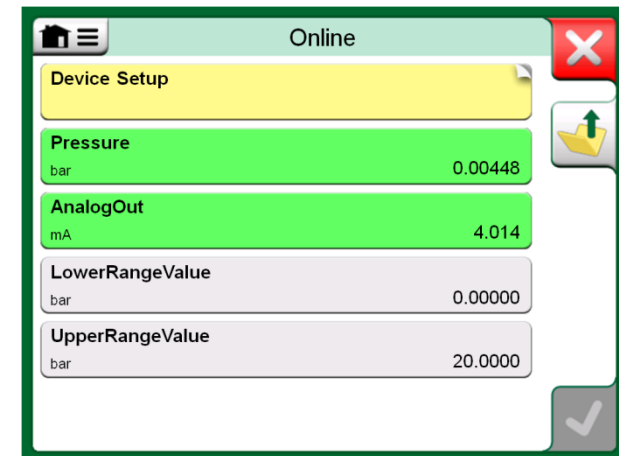

Example of a variable list in a HART Transmitter

CALIBRATING OR DATA LOGGING FIELDBUS INSTRUMENTS

This is a quick guide for selecting a **FOUNDATION Fieldbus** or **Profibus PA instrument's Parameter** for calibration/data logging. If you want to make more extensive configurations, refer to chapter **About Instrument Parameters** on page 64 and the manual of your instrument at hand.

1. First you must select either **FOUNDATION Fieldbus** or **Profibus PA** as your communication protocol and select the instrument as presented in chapter: **Selecting the Instrument** on page 63.
2. **Transducer** is the typical name of the **Block** (folder) where measurement parameters are located. When applicable, tap on it. Note that the **Block** name depends on the instrument, so when uncertain, refer to your instrument's user manual.
3. Browse the opened list of blocks, records and parameters. Tap the one you select for use in MC6, e.g. **Primary Value**.
4. Accept the selection by tapping on the **Accept** button.

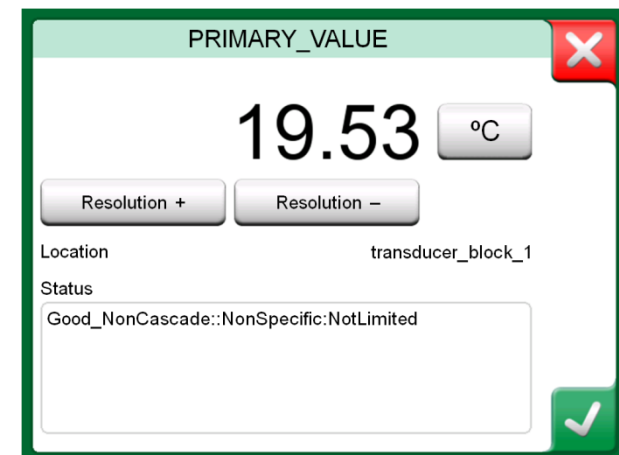

Accepting a parameter.

EDITING PARAMETERS

With "editing parameters" we mean changing any editable parameter in the instrument's memory, e.g. selecting the type of process connection fitted to the instrument.

Editing a Parameter is started by tapping on it. A window opens for editing the data. The type of window depends on the type of parameter that is edited, e.g. a selection list, text or a numeric value.

When editing a stand-alone parameter (stand-alone in this context means it is not part of a record that contains several parameters), the edited value is sent to the instrument immediately when the accept button is tapped on.

In a **HART** instrument: If a parameter is part of a **record**, i.e. several parameters together as in the example picture to the right, each parameter may be edited separately. However, the edited values are not sent to the instrument until the accept button of the record window is tapped on. Prior to sending, edited parameters have a blue background.

See also **Warnings** on page 61.

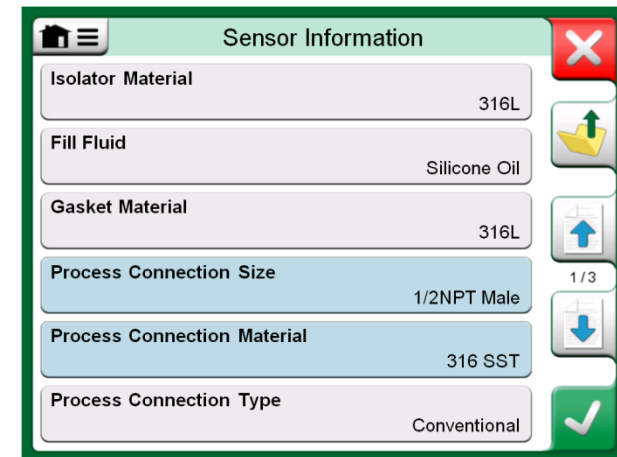

Example of a record: Sensor Information.

Notes.

This manual explains how the parameters are accessed using MC6. For detailed information of instrument data, refer to the manual of the instrument itself.

Beamex cannot be held responsible for any damages caused by changing instrument parameters.

TRIMMING A FIELDBUS INSTRUMENT

Trimming a **FOUNDATION Fieldbus** or a **Profibus PA** instrument can be initiated from the **Documenting Calibrator**, provided the relevant communicator option is enabled and the instrument's Device Description contains information of parameters needed for trimming. See picture to the right.

Menu option **Start Trimming** opens a window similar to the lowermost picture to the right. The list of Blocks and Parameters depends on instrument's Device Description. The lower part of the window has areas where the instrument's input (1) and output (2) readings are shown.

Refer to the instrument's user manual for detailed information on how the trim procedure progresses. Usually you first set the **Mode Block** to OOS (Out Of Service) and then start editing the other data.

The actual trim is done by tapping on **Trim 0 %** or **Trim 100 %** values after a valid input signal is generated/simulated/measured. A window for editing the numeric value opens. The window includes a button for copying the input reading as the correct value.



Copy button

Notes.

Some fieldbus instrument manuals and user interfaces use the term "calibration" when they actually mean a trimming procedure. Be aware of this pitfall when trimming a fieldbus instrument.

Be careful during the trimming procedure. Follow the instructions in the instrument's user manual. Skipping a step in the procedure may result in an unsuccessful trim.

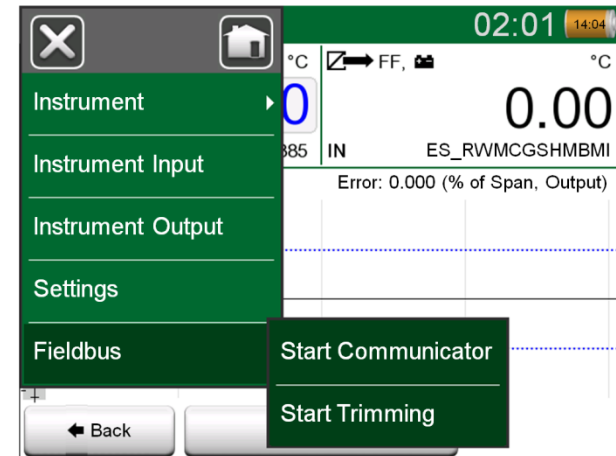

Menu in Documenting Calibrator when calibrating a fieldbus instrument.

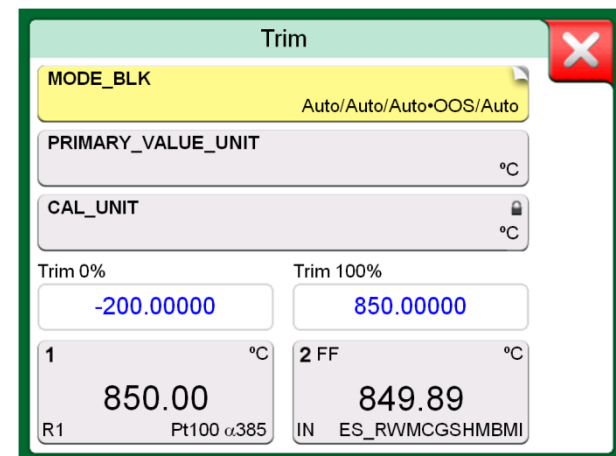

Fieldbus instrument's trimming window, example.

TRIMMING A HART INSTRUMENT

Trimming a **HART** instrument can be started from the **Documenting Calibrator's** menu and also from other MC6's main functions where HART communication may be started. When calibrating a HART instrument, the Documenting Calibrator's menu contains the option **HART Communicator**.

When trimming, refer to the instrument's user manual to locate and start a trimming method, either for the analog or the digital signal / sensor. When the method is located follow its instructions. At some point during the method, you need to apply an applicable input signal. See lowermost picture to the right.

- If the trimming procedure was invoked from Documenting Calibrator, the lower part of the window has areas where the instrument's input (1) and possibly also the output (2) readings are shown. Use the input signal area to check what the correct reading is.
- If the trimming procedure was invoked from another MC6 main function, e.g. Communicator, tap on either of the areas reserved for calibrator readings and select a suitable Quantity for measurement.

In both cases: When the input signal is as required, enter the correct value to the numeric field that is made available at this stage. Optionally, use one of the **Copy** buttons seen on the right side of the window to copy the reading available in the areas reserved for calibrator readings.

To finalize the trim, continue as the trim method describes on MC6's display.

Notes.

Just as in fieldbus instruments, the user interface and manuals of HART instruments are sometimes using the misleading term "calibration" although it is actually a trim that is performed. Be careful during the trimming procedure. Follow the instructions in the instrument's user manual. Skipping a step in the procedure may result in an unsuccessful trim.

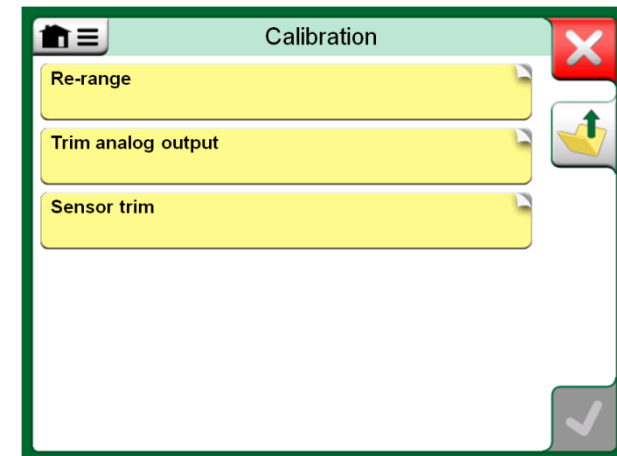

Sensor trim method.

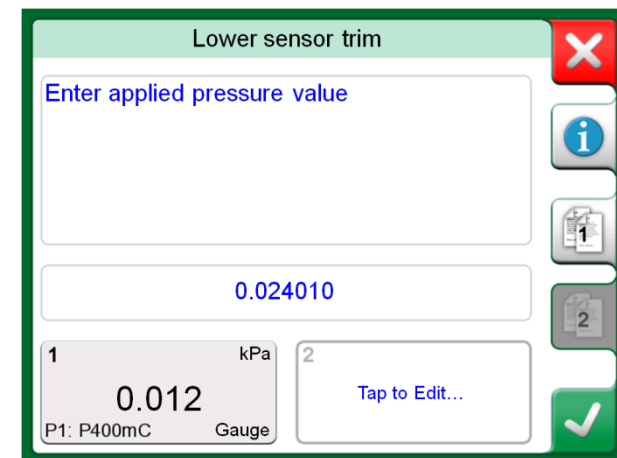

Trim method in progress.

Note.

Typically, the correct order for trimming is: digital output first, then analog output.

HART DEVICE DESCRIPTION SPECIFICS

GENERAL

MC6 supports the use of three kinds of Device Descriptions for HART instruments:

- **Device Specific**, i.e. custom Device Descriptions for the HART device at hand, available in MC6. Full instrument data is available.
- **Generic**, i.e. a library of common Device Descriptions applying to most HART devices. Only a standard set of instrument data is available for instruments containing additional, device specific data.
- **Basic View**, a simplified Device Description available in MC6. It presents the instrument's value parameters only in addition to basic Device Setup and Process Variable Settings.

The default setting of Active Device Descriptions in MC6 may be defined in **MC6's Settings** (see picture on the top right). Also: When connecting to a HART device and selecting the supply, the tools button on the right opens HART settings where you can select the Active Device Descriptions (see picture at the bottom right). This is available in **Calibrator**, **Documenting Calibrator**, **Data Logger** and **Communicator**.

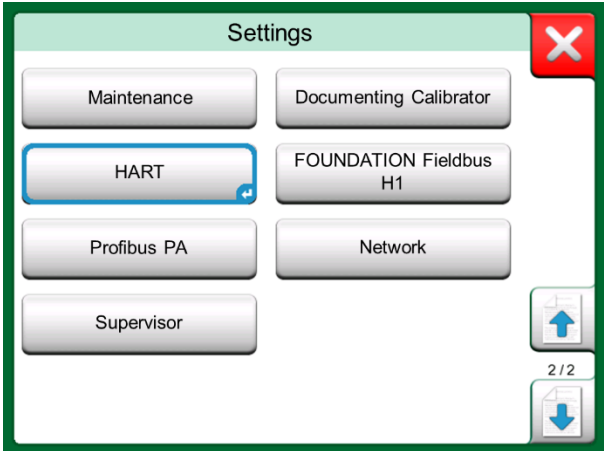

HART in MC6's Settings.

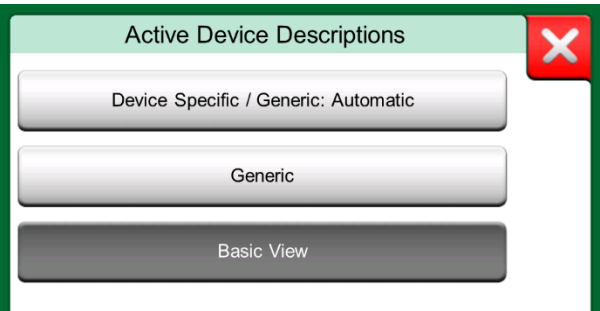

Window for Selecting a Device Description for Use.

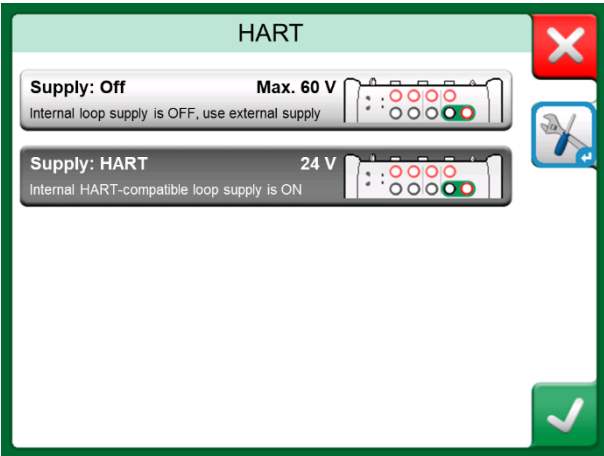

HART Tools elsewhere (note the Hardware Focus Indicator).

BASIC VIEW

MC6's Basic View simplifies the use of HART instruments, since all that is seen are the instrument's value parameters in addition to basic Device Setup and Process Variable Settings. Select any value parameter you like for calibration, data logging etc.

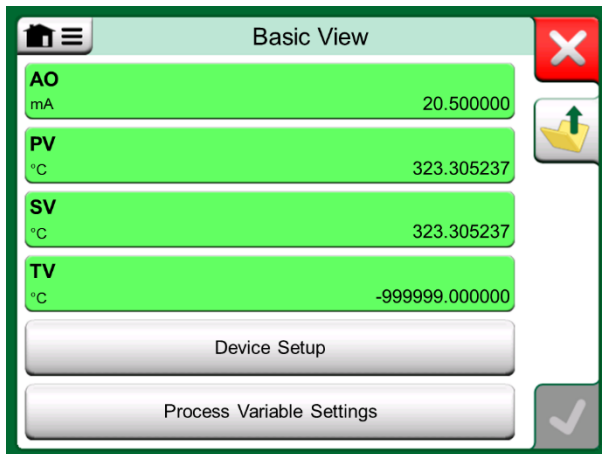

Example of HART Basic View.

The pictures to the right present fields that are available for editing in Device Setup window (top right) and Process Variable Settings window (bottom right).

Note.

HART trimming is not supported when using MC6's Basic View. Use another Device Description when trimming a HART instrument.

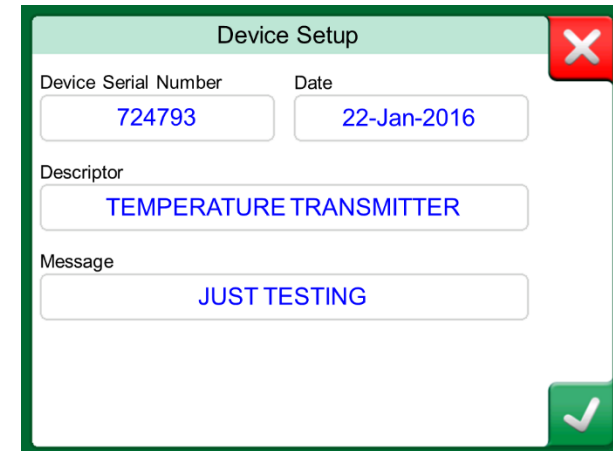

Example of a HART Device Setup Window.

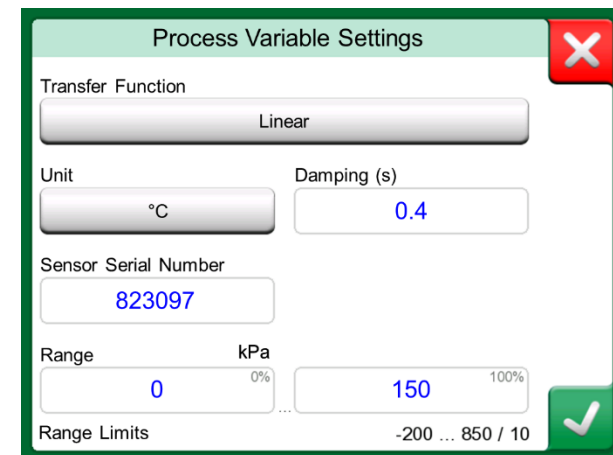

Example of a Process Variable Settings Window.

MANAGING SMART TRANSMITTER CONFIGURATIONS

GENERAL

Beamex offers a possibility to manage smart transmitter configurations using MC6 and a free tool for personal computers: **Beamex MC6 Fieldbus Configuration Viewer**. If applicable, the configurations may also be sent to **Beamex CMX Calibration Software**, as linked documents for a position.

Note.

To be able to utilize this feature you need to have one or more of the necessary options installed (HART®, FOUNDATION Fieldbus H1™ or Profibus PA™).

TOOLS IN MC6

SAVING CONFIGURATIONS

When connected to a smart transmitter, open the menu to locate the **Configuration, Save As** menu option. When selected, MC6 downloads all configuration data and after downloading it, prompts you to give the configuration a name. The default name is the transmitter's Tag name.

This feature is handy especially for customers that have analog DCS system and HART transmitters in the field. They can use this functionality to create a database with all the settings of their transmitters. If a transmitter breaks, all settings are stored in MC6 (alternatively on a PC's hard disk) for easy configuration of the new transmitter replacing the broken one.

Note.

Please note that a saved configuration file cannot be written from MC6 back to a transmitter.

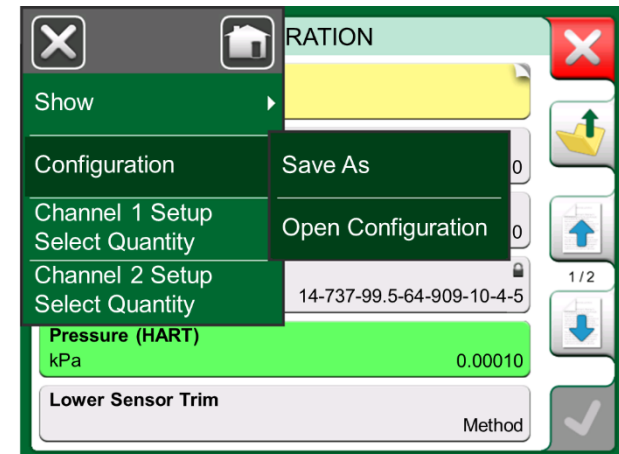

Configuration menu open.

VIEWING/MANAGING CONFIGURATIONS

Opening a list of saved configurations can be opened anywhere in **Communicator**. Open configurations option can be seen in the picture on the previous page and on this page where no protocol is selected yet.

Selecting **Open Configuration** shows a list of saved configurations. The list shows the following information of each saved configuration file:

- The name of the file,
- Manufacturer / Model,
- Date / Time when saved and
- Protocol name.

You can sort the list of configurations according to your own needs with the help of the sorting tools available in the menu. Tap on a configuration to view the saved configuration data. Note that the data cannot be edited.

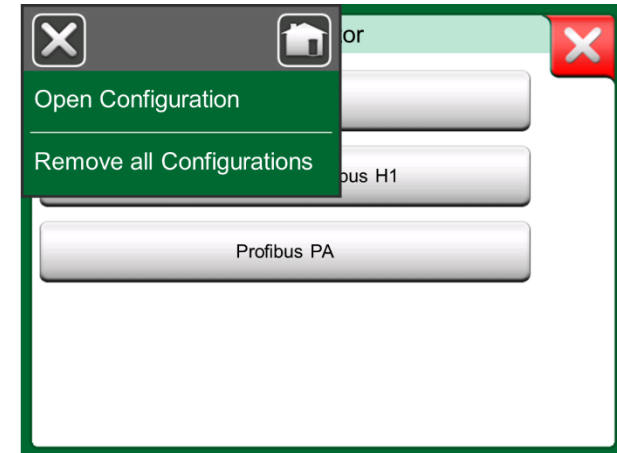

Configuration options in protocol selection window.

BEAMEX MC6 FIELDBUS CONFIGURATION VIEWER

Beamex MC6 Fieldbus Configuration Viewer is a free tool for personal computers with Windows® operating system. Download the Configuration Viewer software from Beamex's web site: <https://www.beamex.com>. Look for **Download Center**.

UPLOADING CONFIGURATIONS

With **Beamex MC6 Fieldbus Configuration Viewer**, you can:

- Read configuration files from MC6
- View the configuration files
- Save the configuration files in PC (e.g. proprietary *.fc file).
- Print the configuration files

LINKING CONFIGURATIONS TO CMX

CMX includes a possibility to link documents to Positions/Devices etc. Use this feature to link the *.fc files to CMX. Double click the link to open it in the viewer.

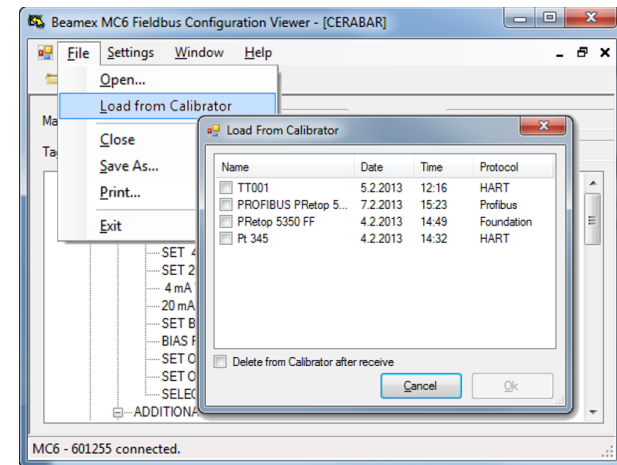

Beamex MC6 Fieldbus Configuration Viewer.

Part 8

Things discussed in this part:

- How to configure MC6 to suit your own needs
- Briefly about re-calibrating/adjusting MC6
- Optional security tool



SETTINGS

SETTINGS

This main function allows you to configure MC6 according to your own needs and also, recalibrate MC6. The following settings/configurations are available:

- **Language** for selecting user interface language.
- **About.** Information about installed modules, firmware options etc.
- **Power Management** for defining auto-off delays and display brightness.
- **Sound Volumes** for setting volumes for different sounds MC6 emits.
- **Date & Time**, including Time Zone selection and activating Daylight Saving Time. See also chapter **Optional Security Tool** on page 75.
- **Regional Settings** for setting local net frequency and default values. See also chapter **Optional Security Tool** on page 75.
- **Owner** for entering owner information, shown in Home View.
- **Controller Presets.** Enabled if you have purchased controller communication options. More in **Part 9, Additional Information.**
- **Maintenance** for re-calibrating/adjusting MC6 and setting calibration date. Also, the possibility to align the Touch Screen. **Important:** Use a stylus when aligning the Touch Screen.
- **Documenting Calibrator.** Settings related to instrument calibration, e.g. is "Save as Both" allowed ("Save as Both" means a single calibration run may be saved both as As Found and As Left calibration.)
- **HART, FOUNDATION Fieldbus and Profibus PA** for defining communication parameters to Digital Communication Instruments.
- **Network** for setting local area network parameters. Future expansion.
- **Supervisor.** Part of **Optional Security Tool.** Read more in chapter **Optional Security Tool** on page 75.

Each setting/configuration is self-explanatory once you have familiarized yourself with MC6's user interface. Configuration screens often have a menu option for recalling factory settings.

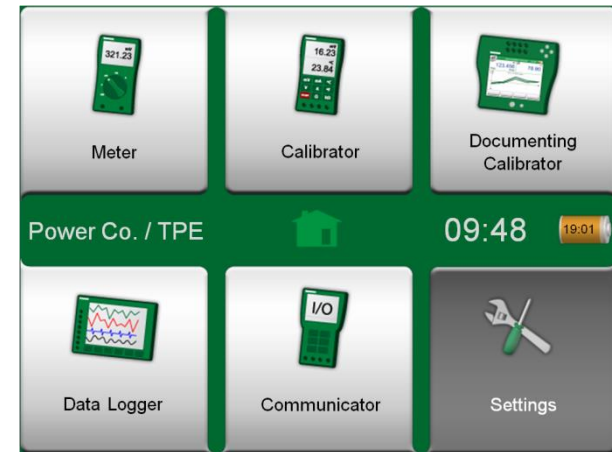

Home View with Settings selected and Owner information defined.

Notes.

MC6's auto off functionality is disabled in the following cases:

- When charger is connected,
- when adjusting MC6's own measurement/generation/simulation ranges,
- when a data log is in progress and
- when an instrument calibration is in progress.

PIN code for setting MC6's calibration date is **2010**. PIN code for MC6's adjustment is device dependent and was shipped together with MC6.

OPTIONAL SECURITY TOOL

GENERAL

Beamex CMX Calibration Software version 2, revision 2.11 and later include an optional tool called **Mobile Security Plus**. It is a tool that enforces security related settings in mobile devices, including MC6. For detailed information about Mobile Security Plus functionality, please see **CMX User Guide**.

The following restriction options are available in Documenting Calibrator's **Supervisor Window** (for a user defined as **Mobile Supervisor** in CMX):

- **None**. No restrictions.
- Mobile Supervisor's **PIN Code** or **User ID & password**. These admin credentials need to be entered before restricted functionalities in Documenting Calibrator are allowed.
- **Blocked**. Restricted functionalities are blocked, i.e. not allowed at all, in Documenting Calibrator.

APPLIED RESTRICTIONS

The following Documenting Calibrator functionalities are either restricted with admin credentials or blocked, depending on the setting in **Supervisor Window**:

- **Skipping** or **undoing** a calibration point,
- **Rejecting** (exiting) an incomplete calibration without saving the results,
- Changing the **calibration date and time** of a keyed calibration,
- **Deleting** calibration results and
- **Deleting** an instrument with calibration results.

Additionally, Changing Regional Settings, Date and Time require admin credentials.

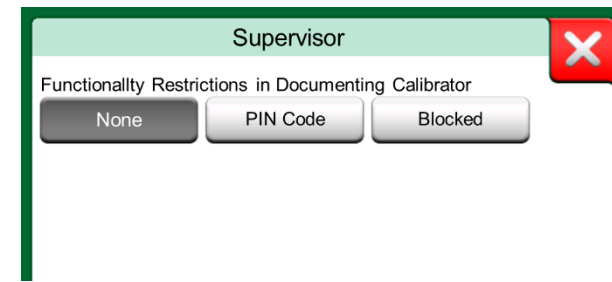

Supervisor Window.

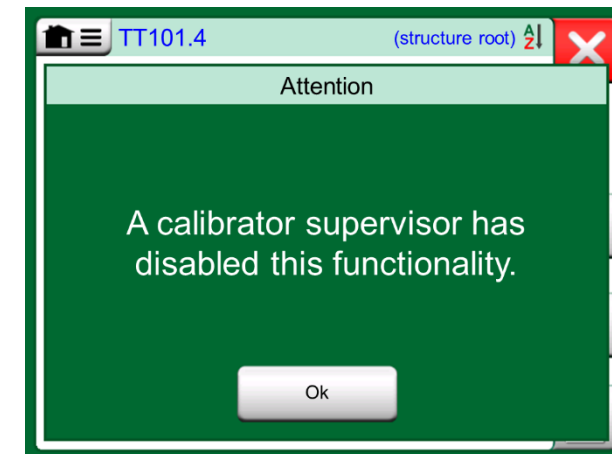

Calibrator's Message When a Functionality is Blocked.

SUPERVISOR WINDOW

To access the **Supervisor** window, you need an admin PIN code. If the necessary option was purchased, the PIN code was shipped together with your calibrator. For increased security, you should change the default admin PIN code to a personal one once you have entered the Supervisor window.

Notes.

When changing the admin PIN code, save the new code in a safe place. There is no way to retrieve the PIN code.

After three wrong attempts, the admin PIN code is locked. Resetting the PIN Code requires contacting Beamex support.

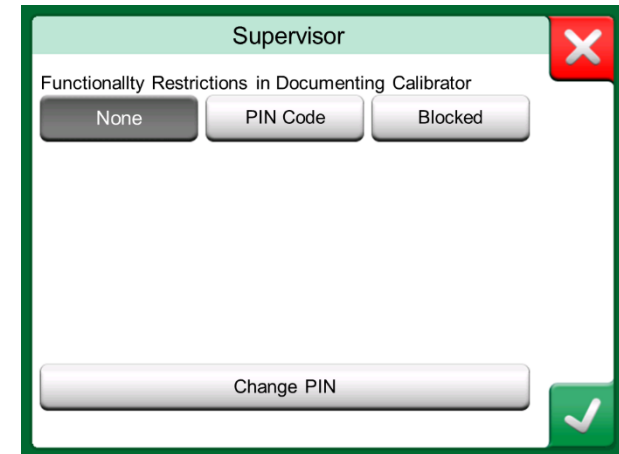

Supervisor Window.

Part 9

Things discussed in this part:

- How to create custom pressure units, PRT sensors and transfer functions.
- Basic Information on how to connect external devices like pressure controllers or temperature blocks to MC6.

ADDITIONAL INFORMATION

ADDITIONAL INFORMATION

This section contains detailed information of some of MC6's more extensive features. The ones presented here are:

- **User Defined Pressure Units**, on page 79,
- **User Defined PRT / RTD Sensors**, on page 80,
- **User Defined Transfer Functions**, on page 84,
- **User Defined Steps / Calibration Points**, on page 85 and
- **Controller Communication**, on page 86.

Pages, where new user defined items can be created, contain a button as seen to the bottom right of this page. Add as many items as is needed; more pages are added when the previous page is full.

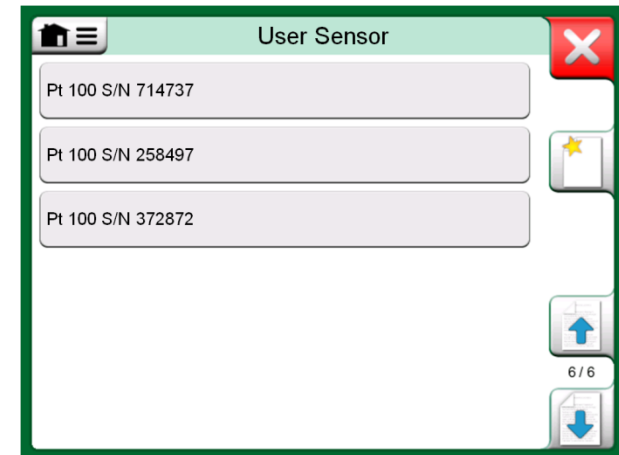

An example of a list of custom PRT sensors entered into MC6.



Create New button

Notes.

These features are meant for experienced calibration technicians familiar with calibrators, especially MC6.

Deleting a user defined item stops a measurement/generation/simulation that was using it.

USER DEFINED PRESSURE UNITS

Wherever in MC6, when you use pressure as the **Quantity**, you may choose a pressure unit from a wealth of already available pressure units, divided into several pages. User defined pressure units may be added to the subsequent page(s).

In the configuration page, see picture below right, give the unit a descriptive name, select a **Reference Unit** and enter the **Factor**. The **Factor** is the relationship between the **Reference Unit** and the custom pressure unit. The **Reference Unit** may be any of the pre-entered pressure units available in MC6.

When a user defined pressure unit is in use, the unit button displays a warning symbol (triangle with an exclamation point inside) together with the name of the user defined pressure unit. See an example below on how a user defined pressure unit is shown in **Calibrator**. Other MC6's main functions display the user defined pressure unit similarly.



User defined pressure unit in **Calibrator**.

Note.

If you need to enter very small or big number into **Factor** field, open the menu available in **Soft Numeric Keypad**. When applicable, the menu contains a possibility to insert an exponent. This allows entering numbers in scientific notation, e.g. 5.775E-07.

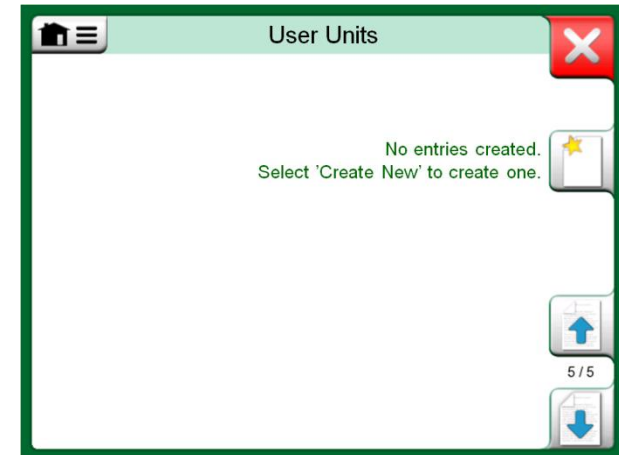

Page 5 of pressure units is reserved for user defined pressure units.

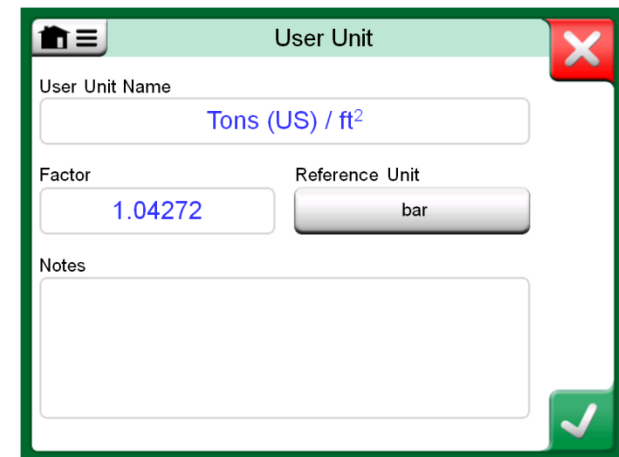

Configuration page.

USER DEFINED PRT / RTD SENSORS

GENERAL

Just as pressure units, MC6 has a wealth of pre-entered standard Platinum Resistance Temperature (PRT) type RTD sensors. They are available wherever you may select **RTD Temperature** as the **Quantity**. However, when using a PRT sensor as a reference sensor, the available standard sensors aren't necessary of use. This is because reference sensors often have custom coefficients in, e.g. their **Callendar - van Dusen** equation .

After the pages with pre-entered PRT sensors, there is room for user defined PRT sensors.

When a user defined PRT sensor is in use, the sensor button displays a warning symbol (triangle with an exclamation point inside) together with the name of the user defined PRT sensor. See an example below on how a user defined PRT sensor is shown in **Calibrator**. Other MC6's main functions display the user defined PRT sensors similarly.



User defined PRT sensor in **Calibrator**.

When defining custom sensors, the **Sensor Calculation Formula** on the first configuration page is important. It affects what is available on further configuration pages. The following chapters present the use of different formulas.

1st configuration page.

Sensor Calculation Formula options

Notes.

For further information about **Sensor Calculation Formulas**, refer to literature related to calibrating Platinum Resistance Temperature sensors.

If you need to enter very small or big number into any of the numeric fields, open the menu available in **Soft Numeric Keypad**. When applicable, the menu contains a possibility to insert an exponent. This allows entering numbers in scientific notation, e.g. -5.775E-07.

CALLNDAR VAN DUSEN FORMULA FOR PRTS

When **CvD RTD (R0, A, B, C)**, i.e. Callendar van Dusen formula is selected, one additional configuration page is added. See adjacent picture.

Callendar van Dusen formula for PRTs can be defined using one of two equations, each with their own coefficients: A, B and C or alpha, delta and beta (α , δ and β). Additionally, a constant, R_0 , is needed to define the sensor.

MC6 supports the use of the equation using coefficients A, B and C only. If your PRT's calibration certificate includes coefficients α , δ and β , use the following equations to convert them to A, B and C:

$$A = \alpha \cdot \left(1 + \frac{\delta}{100}\right), \quad B = \frac{-\alpha \cdot \delta}{10^4} \quad \text{and} \quad C_{T<0} = \frac{-\alpha \cdot \beta}{10^8}$$

Converting coefficients α , δ and β to coefficients A, B and C.

ITS-90 PRT SENSOR

If your calibration certificate includes coefficients for ITS-90 deviation function (International Temperature Scale of 1990) PRT sensor, select **ITS 90 PRT (Rtpw,...)** as the **Sensor Calculation Formula**. Then you may enter the constant, R_{tpw} , and one or more coefficients: a_x , b_x ..., where the subscript x is 4 to 11, depending on the deviation formula used in the calibration.

If the coefficients in your calibration certificate miss the subscripts, use the following table to find which coefficients you have been given.

The screenshot shows a configuration window titled "User Sensor" with a close button (red X) in the top right. It contains four input fields for sensor parameters:

- R₀ (Ω)**: 100.221
- A**: 0.00389561
- B**: -5.6798E-07
- C**: -4.2045E-12

Navigation controls on the right include an up arrow, a "2 / 2" indicator, a down arrow, and a checkmark button at the bottom right.

Example of configuration page for Callendar van Dusen constant and coefficients.

Note.

The definition of coefficient notations for the ITS-90 subranges is described in the NIST Technical Note 1265 "Guidelines For Realizing the International Temperature Scale of 1990".

Calibration ranges, corresponding coefficients and examples of calibration points:

Calibration Ranges*	Corresponding Coefficients	Example of fixed calibration points [#] , °C			
Negative (sub-)ranges:					
-189 ... 0 °C	a₄, b₄	-189.3442,	-38.8344,	0.01	
-38 ... 30 °C	a₅, b₅ ^(†)	-38.8344,	0.01,	29.7666	
Positive (sub-)ranges:					
0 ... 30 °C	a₁₁	0.01,	29.7666		
-38 ... 30 °C	a₅, b₅ ^(*)	-38.8344,	0.01,	29.7666	
0 ... 157 °C	a₁₀	0.01,	29.7666,	156.5985	
0 ... 232 °C	a₉, b₉	0.01,	156.5985,	231.928	
0 ... 420 °C	a₈, b₈	0.01,	231.928,	419.527	
0 ... 660 °C	a₇, b₇, c₇	0.01,	231.928,	419.527,	660.323
0 ... 962 °C	a₆, b₆, c₆, d	0.01,	231.928,	419.527,	660.323, 961.78

†) sub-range 5 is presented twice since it needs to be entered separately both for negative and positive sides.

When selecting **ITS 90 PRT (R t_{pw},...)** as the **Sensor Calculation Formula**, the **Sensor Range** entered in the 1st configuration page defines how many additional **User Sensor** pages is added to MC6. If the range includes temperatures below zero, the total amount of configuration pages is four:

1. First page for general settings. See page 80.
2. Second page for entering the **R t_{pw}** constant value.
3. Third page for selecting the deviation formula for **negative** temperature sub-range and entering the coefficients (a₄ and b₄ or a₅ and b₅).
4. Fourth page for selecting the deviation formula for **positive** temperature sub-range and entering the coefficients (a₅, a₆, a₇ ... etc.).

When no negative sub-range is included in the calibration, the third page mentioned above is not included and the total amount of configuration pages is three.

Note.

If your calibration certificate include two sets of coefficients. One for zero current and another for 1 mA current, enter the latter ones into MC6.

*) The range limits in the adjacent list are rounded and shown as they are on MC6 User Interface.

#) Not all calibration laboratories necessarily use the same points. These are for reference only.

Examples of coefficients a₇, b₇ and c₇.

FACTOR

The third way to customize a RTD sensor (not just PRTs but all types of RTDs) is using the **Factor**. This applies for sensors with the same relative error throughout the sensor's span, a sensor with an "offset" in its output.

How to Configure a User Sensor using Factor:

Select a standard **Sensor Type**. Then enter a **Factor** that offsets the standard temperature curve. A simple way of doing it is taking a standard RTD sensor with a 1 ohm resistance @ 0 °C, e.g. Pt1. Then enter the real resistance @ 0 °C as the **Factor**.

Configuration page for Factor

CHECK SENSOR CONVERSION

MC6 has a possibility to test sensors in the window presenting pre-entered and custom RTD sensors. The menu has an option: **Test Sensor Conversion**.

The adjacent picture presents the first of the **Test Sensor Conversion** pages. It allows you to select a sensor, the unit to be used and a possibility to test a single point. This is handy when you have entered coefficients of a custom sensor and want to test if the coefficients were entered correctly. Enter, e.g. a temperature that is in the calibration certificate and check if the calculated resistance in MC6 is the same as on the calibration certificate. If yes, the entered coefficients in MC6 are correct. If not, check the coefficients you entered.

The lower part of the first page allows you to define step sizes for tables seen on the second and third page. There you can see the sensor's temperature vs. resistance correlation (and vice versa) in table format.

Sensor test configuration and single point test page.

USER DEFINED TRANSFER FUNCTIONS

Transfer Functions are available in Calibrator's **Scaling Tool** and in **instrument definitions** found in Documenting Calibrator.

When creating/selecting a user defined transfer function, tap on the **Transfer Function** button and browse to the **User Transfer Function** page.

The configuration consists of two (or more) pages as shown in the pictures to the right of this text. The first page is for general definitions and the second for entering known transfer function points. If you enter more points than can be shown on one page, a further page is automatically added.

There are some "rules" on how to enter the transfer function points:

- The first point is always pre-entered and the values are not editable. They are the ranges' 0 % values.
- Manually entered points must be in increasing order.
- Last point must be exactly or greater than the range's 100 % value.

Also:

- The row number is a button. It opens a window where you may delete the current point or optionally add a row either before or after the current point.
- An added point gets default values: average values of preceding and following point.

1st configuration page.

	Input (bar)	Output (mA)
1.	0.00000	4.00000
2.	1.00000	4.05000
3.	3.00000	4.78800
4.	5.00000	6.82000
5.	7.00000	11.0440
6.	Tap to Edit...	Tap to Edit...

2nd configuration page.

USER DEFINED STEPS / CALIBRATION POINTS

These are available for instruments in **Documenting Calibrator** and also in **Calibrator's Step** tool. Use either **Calibration Points** or **Step Definition** button to modify its setting. In the opened window, browse to **User Test Points** page.

The configuration consists of two (or more) pages as shown in the pictures to the right of this text. The first page is for general definitions and the second for entering steps / calibration points. If you enter more points than can be shown on one page, a further page is automatically added.

There are no "rules" in what kind of values are entered. They may be outside given point data entry range and need not to be in any strict order. See the lower picture to the right.

Also:

- The row number is a button. It opens a window where you may delete the current point or optionally add a row either before or after the current point.
- An added point gets a default value: Average value of preceding and following point.

1st configuration page.

#	Point Data (V)	=%
1.	1	0%
2.	0.95	-1%
3.	1	0%
4.	1.05	1%
5.	1	0%
6.	Tap to Edit...	

2nd configuration page.

CONTROLLER COMMUNICATION

MC6's communication with External Controllers (Pressure and Temperature) connected to the USB-A ports is optional. Check what options your MC6 has from the **Settings** window. Tap on the **About** button and browse to page with **Installed Options** information.

WHAT CAN BE DONE WITH CONTROLLER COMMUNICATION

Ways of using an External Controller with MC6:

- Controller (full use).**
 MC6 uses the External Controller to set and measure the signal. Controller can be taken into use in MC6's Port/Function list in MC6's **Calibrator**, **Documenting Calibrator** and **Data Logger**. See example in uppermost picture to the right. In **Beamex CMX Calibration Software**, this corresponds to *Input Method Controlled and Measured*.
- Measurement (only).**
 The External Controller acts like an external measuring device (comparable to an EXT External Pressure Module). This feature needs to be activated in MC6's **Controller Presets** window. More of **Controller Presets** window further on. When activated, Measurement is available in Port/Function lists in MC6's **Calibrator**, **Documenting Calibrator** and **Data Logger**. Again, see uppermost picture to the right.
- Control (only).**
 MC6 uses the External Controller to set calibration points. It is measured by some other means, e.g. MC6's Pressure Module. This is available in MC6's **Documenting Calibrator** only. See lowermost picture to the right. In **CMX**, this corresponds to *Input Method Controlled*.

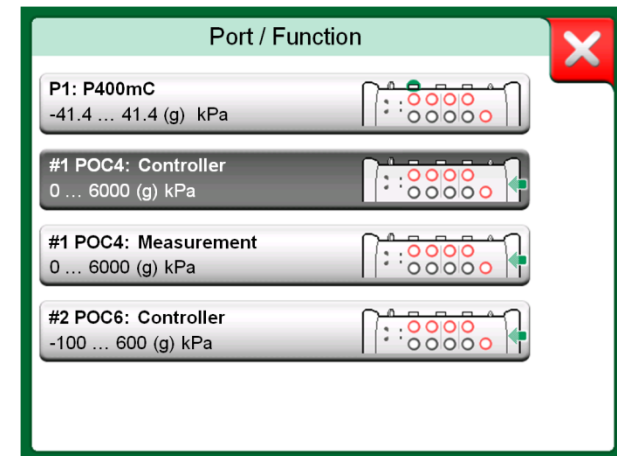

Pressure Port / Function list with **Controller** and **Measurement** available.

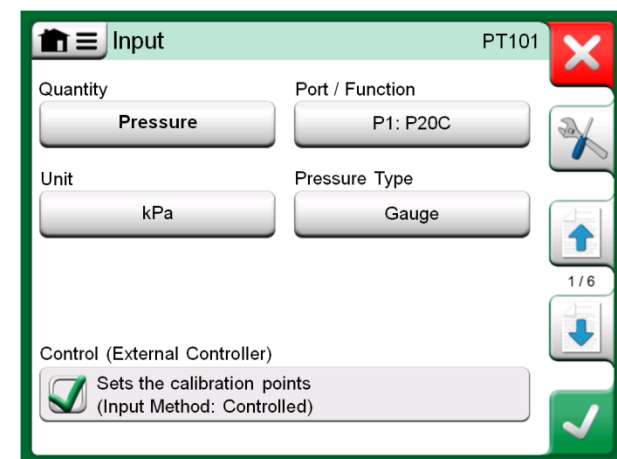

Instrument input settings with **Control (only)** selected.

Important!

When connecting a Beamex FB or MB Temperature Dry Block to MC6, ensure that both devices are up and running before connecting a communication cable and invoking communication between them.

CONFIGURING CONTROLLER COMMUNICATION

Before utilizing External Controllers, both the communication cable / driver and the controller itself need to be configured in MC6. We recommend this to be done using the **Controller Preset** window available in MC6's main function **Settings**. MC6 supports up to four presets. Each of the presets create a pair of a **Connection Interface** (communication cable / driver) and a **Controller Type**. See adjacent picture.

The menu in a **Controller Preset** window contains further tools for defining the communication. One of the menu items is **Enable Measurement Port**, defining if the is controller also used as a measuring device. Menu selections may be individual for each preset.

When an External Controller is connected and configured, it is available as any port in MC6's user interface.

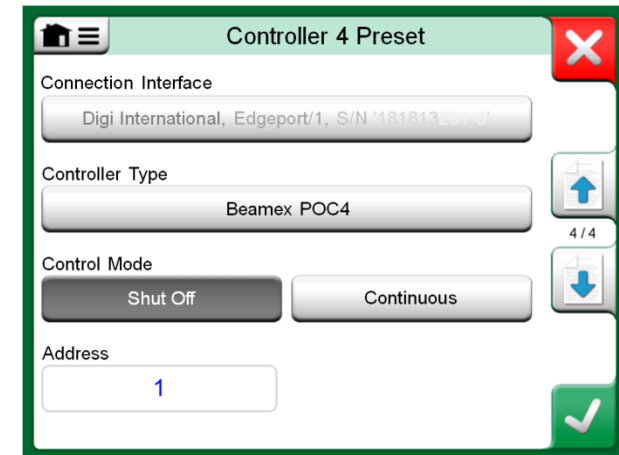

Example of a Controller Preset.

CHANGING CONTROLLER DURING CALIBRATION

In Documenting Calibrator, you may need to change the controller during calibration. This, e.g. because a temperature controller's span is not useful throughout the measurement span of the instrument to be calibrated.

Change the controller as follows:

1. During calibration, open the **Documenting Calibrator's** Menu.
2. Select option **Instrument Input**.
3. In the **Instrument Input** window, tap on the button that invokes the controller change procedure.
4. Follow the instruction on the screen.

Notes.

If you run into communication problems, check the communication settings of the connected controller. They may have been changed from the controller's default values. MC6 always uses the controller's default values.

The Controller Preset window's menu includes an option to view the **Communication Log**. In the Communication Log window you may choose the log format: binary or textual.



Appendix

Things discussed in this part:

- Safety Issues and Warnings
- Disposal of Waste Electrical and Electronic Equipment
- Servicing MC6
- Statements and Warranty
- Index

APPENDIX

SAFETY

MC6 has an IP65 water/dust proof case. The materials of MC6's case withstand normal industrial conditions. MC6 endures shocks with the help of the built in impact protectors.



Internal pressure modules with a measuring range of 6 bar (90 psi) or less are overpressure protected. If the measurement pressure of a pressure module exceeds the module's maximum pressure value, the overpressure protector vents excess pressure through a hole in the rear of the case.

APPROVALS

Safety	Directive 2006/95/EC, EN 61010-1:2001
EMC	Directive 2004/108/EC, EN 61326-1:2006
Ingress protection	IP65, Standard: IEC/EN 60529
Drop/Shock/Vibration	IEC 68-2-32

SYMBOLS USED

The following symbols concerning electrical safety are used in MC6.

	Alternating current, AC
	Direct current, DC
	Caution! See manual for further information

SAFETY PRECAUTIONS AND WARNINGS

MC6 is a precision tool that should be used by skilled people who have read and understood this manual. Working with MC6 involves the usage of pressure and/or electrical instruments. Be sure to know how to work with these instruments and how to safely connect/disconnect pressure hoses as well as electrical test leads clips, etc.

Sometimes it is necessary to use a portable radio transceiver while working with the calibrator. To prevent calibration errors caused by the radio frequency interference, keep the radio far (at least 1 meter) from the calibrator and the circuit under calibration while sending.

OPERATING CONDITIONS

Temperature	-10 ... 45 °C (14 ... 113 °F)
Humidity	0 to 80 % R.H. non condensing
Max. altitude	3000 m (approx. 9,800 ft)

See also storing conditions in chapter: **Storing**, on page 93 and charging conditions in chapter **Charging the Lithium Polymer Battery Pack**, on page 93.

GENERAL WARNINGS

Do not use MC6 in any other way than as described in this User Manual. If this equipment is used in a manner not specified by the manufacturer, the protection provided by it against hazards may be impaired.

Use MC6 only if you are certain of that it can be used safely. Safe use of MC6 is no longer possible if one or more of the following cases are true:

- When the case of MC6 is evidently damaged
- When MC6 is not functioning as expected
- After prolonged storage in unfavorable conditions
- After serious damage during transport

Do not tap the touch screen with sharp or hard objects or press hard on the display, especially with fingernails. Instead, tap lightly using your fingertips.

WARNINGS CONCERNING THE LITHIUM POLYMER BATTERY PACK

Lithium-Polymer (LiPo) batteries require very careful handling. To prevent accidents or damage to persons or property, follow all safety precautions and warnings presented here.

Always use battery pack delivered by Beamex. Use of battery packs not meant for MC6 is dangerous. When replacing a battery make sure the polarity is correct. Never short circuit the battery pack. Not observing these warnings may result in an explosion.

Do not leave the battery pack in a car on a hot day, in direct sunlight or close to any heat source. Heat causes loss of performance and the battery pack may even ignite and explode. See Operating Conditions, on page 91 as well as charging and storing conditions on next page.

Do not use the battery pack, if in any situation, the battery emits an unusual smell, heats up, is deformed or is otherwise behaving unusually. Remove and check the condition and behavior of the battery pack especially after MC6 has for some reason been knocked or dropped.

Never disassemble the battery pack. The battery pack contains safety and protection electronics. If the electronic is damaged, it may cause the battery to warm up, or even ignite and explode.

If the battery pack leaks and fluid comes in contact with your skin, carefully wash with soap and water. If fluid gets in your eyes, flush with plenty of cold water and seek immediate medical care.

Never extinguish a Lithium Polymer fire with water. Do not expose battery to water or salt water, or allow the battery to get wet.

DISPOSAL OF BATTERY PACK

First you must discharge the battery pack, using MC6 normally. Then remove battery pack as described in chapter Removing Replacing the Batteries in Part 1, Introduction. To avoid short circuiting the terminals, insulate them with adhesive tape. Finally, place battery pack in a fire proof container and dispose according to local regulations.

Do not transport the Battery Pack to be disposed as cargo or freight.

Replace the Battery Pack with a new one bought directly from Beamex or from a Beamex representative. Contact information is on the prepages of this manual.

Do not replace the Battery Pack with any other Battery Pack type than the one available from Beamex/representative! Using other type of Battery Packs may render MC6 unsafe – fire or explosion may occur. Also: Use of other Battery Packs voids the warranty.

CHARGING THE LITHIUM POLYMER BATTERY PACK

Charge the battery pack using only the charger provided with MC6. MC6 should never be left unattended while charging.

The charger operates in the following environments:

Voltage: 100 ... 240 VAC

Frequency: 50/60 Hz

Indoor use only, IP 40.

Charge within the following temperature range:

0 °C to 40 °C (32 °F to 104 °F).

Charge MC6 away from flammable items or liquids.

Use the charger in environments containing limited amounts of dust and humidity, e.g. in a laboratory or an office.

If the battery pack starts to heat up or deform, stop charging process immediately and disconnect the charger. Place MC6 in a fire proof location and wait for approx. 15 minutes. If no problems occur, try charging again, but be extra careful and oversee how the charging progresses. It is better to replace a faulty battery pack than risk serious damages.

Do not continue charging the battery, if it does not recharge within the specified charging time. Charging time is approximately 4 hours (for 4400 mAh battery pack).

After extended periods of storage, it may be necessary to charge and discharge the cells or batteries several times to obtain maximum performance.

STORING

When transporting or temporarily storing MC6's battery pack, store it in 30/40 % charged state. Storing in a fully charged or discharged state results in substantial capacity loss, or malfunction of the protection electronics.

Recommended storing temperature for the battery pack is between -20 °C to 45 °C (-4 °F to 113 °F). The lower the temperature (but well above freezing point) the better for keeping up the capacity.

Note.

When MC6 is not used for a longer period, charge MC6 in 3 month periods.

WARNINGS CONCERNING ELECTRICAL MEASUREMENT AND GENERATION

MC6's OUT section terminals are protected against over voltage and over current as far as it has been possible without affecting the accuracy. Do not however connect signals that are above the measurement range of the selected Function.

Maximum output voltage from MC6's terminals is below 30 V. If you, however, connect together voltages from the IN and OUT sections or if you connect external voltages to MC6, the resulting voltage may be high enough to be hazardous.

There is no galvanic isolation between the connectors on the right side or the internal pressure module connectors.

Although there is a galvanic isolation between MC6's IN and OUT sections, it is for functional purposes only. Do not exceed 60 VDC / 30 VAC / 100 mA between any terminals.

Functional insulation is not intended for protection against transient overvoltages. Do not connect measuring terminals to circuits where transient overvoltages are possible.

GENERAL WARNINGS CONCERNING PRESSURE MEASUREMENT

The maximum pressures of available optional pressure T-hoses:

- 20 bar at 21°C (290 psi at 70°F).
- 40 bar at 21°C (580 psi at 70°F).

Applying higher pressure than the maximum pressure can be hazardous.

We recommend the use of the optional pressure hose sets. When using other hoses and connectors, make sure they are high quality products that withstand the used pressure.

To avoid damaging the calibrator, use hand tightening only (max. torque 5 Nm) when connecting the pressure measurement hose to the internal pressure module. If the use of tools is required to secure the connection (typically an internal pressure module with a pressure range of 20 bar / 300 psi), apply the counterforce with a spanner on the connector body's hexagonal part.

Always depressurize the system before opening or connecting any pressure fittings or connectors. Use proper valves for venting the system. Ensure that all connections are made correctly and that the hose and the connectors are intact.

The allowed pressure media for internal pressure modules is inert, non-toxic, non-explosive media. External modules have the allowed media printed on the module's sticker. Using unsuitable pressure media may destroy the pressure module/calibrator.

External Pressure Modules: Use only the pressure media stated on the pressure module. Use of wrong type of Pressure Media may destroy the pressure module.

Never exceed the maximum pressure of a pressure module. The internal pressure module's maximum pressure is stated on calibrator's sticker. The maximum pressure of external modules is stated on module's sticker and mentioned in the Instruction Booklet that is provided with the external module.

Never plug a hose with your hands or put hands in front of a gas spray coming from a leakage. A gas bubble in the blood circulation can cause death.

WARNINGS CONCERNING HIGH PRESSURE

High pressure is always dangerous. Only personnel with good experience and knowledge of high pressure liquid, air and nitrogen operations are allowed to work with the module. Read carefully all these instructions and familiarize yourself with local safety instructions for high pressure operations before starting the use.

When using gas, the system must not contain any liquid, especially if you do not know how they may react under pressure. Use of clean air or nitrogen is recommended as gaseous pressure media. Liquid pressure media should be preferred when using modules with a pressure range of 60 bar (30000 psi) or more.

If you use nitrogen, minimize the leak to the atmosphere and take care of sufficient ventilation. Close the valve of the nitrogen cylinder, when the system is not in use. Increase in the percentage of nitrogen in the ambient air may cause unconsciousness and death without warning. Read carefully the safety instructions for nitrogen and make sure that the other people in the same space are aware of the danger.

Use of liquid pressure medium is recommended with pressure measurement modules at higher pressure range. Use water or suitable hydraulic oil. Check that the used liquid is not aggressive against the materials used in the transducer or tubing. When using liquid, minimize the amount of air in the system. So you can minimize the amount of spilled liquid in case of leakage.

Do not use the same tubing with different liquids or gases.

Check what the local regulations say about construction and use of pressurized vessels. The regulations normally control construction and use of systems where the product of the pressure and volume exceeds a certain limit. The volume of this system depends on the instrument connected to it.

High pressure gas is dangerous because it can break the container and the flying splinters may cause injury. Also small leaks of gas may be dangerous because the high velocity of the leaking gas jet enables penetration through skin. If a gas bubble gets into the blood circulation, it can cause death. The leak jet is particularly penetrative, if some liquid is coming with the gas.

DISPOSAL OF WASTE ELECTRICAL AND ELECTRONIC EQUIPMENT

BEAMEX AND WEEE

Beamex is an environmentally conscious company developing products with a view to ensure that they are easy to recycle and do not introduce hazardous materials into the environment.

In the European Union (EU) and other countries with separate collection systems, waste from electrical and electronic equipment (WEEE) is subject to regulations.

EU WEEE Directive 2012/19/EU (the WEEE Directive) requires that producers of electronic equipment are responsible for the collection, reuse, recycling and treatment of WEEE which the Producer places on the EU market after August 13, 2005. The objective of this regulation is to preserve, protect and improve the quality of the environment, protect human health, and conserve natural resources.

DISPOSAL OF BATTERY PACK

MC6 contains a Lithium Polymer (LiPo) battery pack. Before disposing of MC6, discharge the battery pack, then remove it from MC6 (see chapter **Removing Replacing the Batteries** in **Part 1, Introduction**). Further information of the battery pack is in chapter **Warnings Concerning the Lithium Polymer Battery Pack** on page 92.



The symbol above is engraved on the product's back side. It indicates that this product should be handed over to applicable collection point for the recycling of electrical and electronic equipment.

For more detailed information about recycling of this product, please contact your local representative or your waste disposal service.

SERVICE

SENDING MC6 FOR SERVICE

When sending MC6 for service, follow regulations related to transporting devices containing Lithium Polymer Batteries. Read also chapter **Warnings Concerning the Lithium Polymer Battery Pack**, on page 92.

For further information, contact Beamex. Contact information is on the prepages of this manual.

FIRMWARE UPDATE

The quickest way to see if a new firmware version is available is checking out Beamex's web site (<https://www.beamex.com>). Look for **Downloads Center** and see what it says about MC6 firmware versions and downloads. Also check for possible release notes accompanying the update file.

Transfer the update software to a USB Stick (USB Flash Memory). Make sure MC6 is **powered off**. Connect the USB stick to one of MC6's USB-A ports. Press and hold the **Left** and **Right** hardware arrow button and push the **On/Off** button. The update starts automatically. Follow the instructions seen on MC6's screen. The update is a multi phase process, so be patient.

Notes.

Updating MC6 firmware do not erase any user entered data (instruments, calibration results, data logs etc.). Supported file systems on USB Flash Memories are FAT 32 and FAT 16.

RESETTING MC6

Sometimes you may want to reset/restart the calibrator. To do that, press and hold the Home and Enter keys for 7 seconds.

Note.

MC6 does not lose time, date or saved data during the reset. It just resets the main processor. Possible open files may however be lost.

THE BATTERY CHARGER

The charger is not intended to be serviced. When unusable it can be disposed according to local waste disposal regulations.

RECALIBRATING MC6

As any test and measurement device, we recommend to recalibrate MC6 at regular intervals. This ensures accuracy and operating reliability throughout MC6's lifetime.

MC6 is a high-accuracy calibrator and it should be recalibrated only at laboratories being able to offer sufficient uncertainty. Please note that all calibration laboratories are not able to offer required uncertainty. It is highly recommended that the calibration laboratory is accredited (ISO 17025) and has certified quality system in place.

For advice, please contact Beamex.

By sending the calibrator to Beamex or your closest Beamex authorized service center for recalibration, you can be sure that your equipment will be cleaned, fully tested, loaded with the latest firmware/features, and recalibrated in a state-of-the-art calibration facility that meets the specifications of the calibrator.

Note.

When setting MC6's calibration date, see **Part 8, Settings**.

CLEANING MC6

If MC6 needs cleaning, use cloth soaked with a mild solution of tall oil soap (pine soap). Wait a few minutes and then clean using a cloth moistened with pure water. Never use any strong detergents.

Note.

To clean the display, use a microfiber cloth. If necessary, use a mild detergent and remove it thoroughly when ready.

STATEMENTS

DISCLAIMER

Beamex has taken great care to ensure that this manual contains both accurate and comprehensive information. Notwithstanding the foregoing, the content of this manual is provided “as is” without any representations, warranties or guarantees of any kind, whether express or implied, in relation to the accuracy, completeness, adequacy, currency, quality, timeliness or fitness for a particular purpose of the content and information provided on this manual. The content of this manual is for general informational purposes only. To the extent permitted by law, Beamex shall not be liable for any direct, indirect, special, consequential or incidental loss or damage (including but not limited to damage for third parties and loss of use, loss of profit and loss of production) in relation with the use of this manual, even if Beamex has been advised of the possibility of such damages.

Beamex reserves the right to amend this manual at any time without prior notice. Furthermore, the products this manual describes are subject to change without prior notice due to Beamex’s continuous product development process.

CE

This product conforms to the European Union directives 2004/108/EC and 2006/95/EC.

INTELLECTUAL PROPERTY RIGHTS

COPYRIGHT

The content of this manual is the property of Beamex Oy Ab and/or its subsidiaries and affiliates (referred hereinafter as Beamex). This manual and its content are protected by international copyright laws and all copyrights are retained by Beamex. All rights reserved. Reproduction, distribution, transfer or storage of the content presented in this manual, in whole or in part, is illegal and prohibited without the prior written consent of Beamex.

The Beamex MC6 is a product of Beamex and contains HCF SDC-625 technology. The HCF SDC-625 technology is owned by HART Communication Foundation (HCF), 9390 Research Blvd., Suite I-350 Austin, Texas 78759, USA, and may not be adopted, copied, reproduced, modified, licensed, sublicensed, sold or resold other than under license from HCF.

The Beamex MC6 contains licensed software which requires that its source code is available for you. Please contact Beamex to obtain it.

The Beamex MC6 is based in part on the FLTK project (<http://www.fltk.org>).

TRADEMARKS

“Beamex”, “Beamex – World-Class Calibration Solutions as well as the color combination of green and black as applied to the major part of the visible surfaces of a measurement device, are registered trademarks of Beamex Oy Ab. No content provided in this manual should be interpreted as a permission or license to use Beamex trademarks. The use of Beamex trademarks without the approval and consent of Beamex is prohibited and violates trademark laws.

FOUNDATION Fieldbus is a trademark of Fieldbus Foundation. PROFIBUS is a trademark of PROFIBUS International. HART is a registered trademark of the HART Communication Foundation. Windows is a registered trademark of Microsoft Corporation in the United States and other countries.

All other trademarks or trade names mentioned in this manual are the property of their respective holders.

INDEX

A

- About this manual.....2
- Accessories..... 14
- Additional Info 34
- Alarms.....33
- Approvals 90
- Auto-Off Settings..... 74

B

- Backlight4
- Batteries..... 10, 92
 - Charging.....93
 - Disposing.....92, 93
 - Removing/Replacing 11
 - Storing93
- Buttons.....7
 - Accept.....5
 - Check Boxes5
 - Close5
 - Hardware Focus Indicator5
 - Home4
 - Menu.....5
 - Power4

C

- Calibration..... 37
 - Changing the Pressure Module 43
 - Customizing Mapping 50
 - Deleting Results..... 48
 - Group Calibration..... 45, 46
 - Instrument Overview 41
 - Mapping Instrument Data 49
 - Saving Results 43
 - Selecting a Fieldbus Parameter..... 65
 - Selecting a HART Parameter 65
 - Viewing Results 48
- Calibration Points
 - User Defined..... 85
- Calibration software..... 12, 14, 36
- Calibrator 32
 - Inheriting Settings 16
- CE Conformity..... 99
- Changing Controller During Calibration..... 87
- Charger..... 98
- Charging the Battery Pack..... 93
- Check Boxes 5
- Cleaning MC6 98
- Communication Settings 74
- Communicator..... 60
 - Connections 62
 - Editing a Parameter 66
 - List of Instruments..... 63
 - Selecting a Variable 64
 - Selecting the Instrument 63
 - Trimming a Fieldbus Instrument 67
 - Trimming a HART Instrument 68
- Configurations (Smart Transmitters)
 - Managing 72
 - Saving 71
 - Viewing 72

Connections

- Fieldbus/HART62
- General.....16
- Thermocouple28
- Connectors
 - Ethernet.....8
 - Front side7
 - Power Supply8
 - Pressure Modules8
 - R2.....8
 - Right side7, 8
 - Top8
 - USB8
- Controller Communication 86
 - Changing Controller87
 - Configuring87
- Controller Settings..... 74
- Copyrights..... 100
- Current Generation 24
- Current Measurement 18

D

- Damping 34
- Data Logger 54
 - Configuring.....55
 - Deleting Results57
 - Saving Configurations55
 - Saving Results57
 - Selecting a Fieldbus Parameter65
 - Selecting a HART Parameter65
 - Starting56
 - Transferring Results to a PC.....58
 - Viewing Results57
- Date & Time Format..... 74
- Date/Time Fields..... 6
- Disclaimer 99
- Display 9
- Disposing MC6..... 96
- Documenting Calibrator..... 36

Inheriting Settings	16
Drop/Shock/Vibration Approval	90

E

Editable Fields	
Date/Time	6
Numeric	6
Text	6
EMC Approval	90
Entering	
Numbers	22, 23
Ethernet	
Connector	8
External Controllers	87
External Pressure Modules	17
External Reference Junction	28

F

Factory Hierarchy	38, 39
Fieldbus Instruments	44, 60
Fieldbus Settings	74
Firmware	5
Update	97
Fixed Reference Junction (Temperature)	28
FOUNDATION Fieldbus™	60
Frequency Measurement	20
Front side	
Connectors	7
Function Info	34

G

Generation (see also Simulation)	
Changing the generated value	22
Current	24
Frequency	26
Pulses	27
Voltage	24
Group Calibration	45, 46
Collecting Instruments	45
Editing a Group	46
Settings	46, 47

H

Hand Pumps	14
Hardware Focus Indicator	5
Hart Settings	74
HART®	44, 60
Headers, described	2
Home Button	4
Home View	4

I

Ingress Protection Approval	90
Inheriting Settings	16
Instrument	38
Instrument list	38
Internal Barometric Module	9
Internal Reference Junction	28

L

Language	74
Leak Test	33
LED	11
Lithium Polymer Battery Pack	92
Loop supply	18

M

Maintenance	74
Managing Smart Transmitter Configurations	72
Manual Reference Junction (Temperature)	28
Mapping Instrument Data	49
Customizing	50
MC6	
Approvals	90
Charger	98
Cleaning	98
Firmware	5
Hardware	7
Recalibrating	98
Resetting	97
Safety	90
Servicing	97
Starting	4
Warnings	90
MC6 Fieldbus Configuration Viewer)	72

- Measurement 32
 - Calibrator 32
 - Current 18
 - Frequency 20
 - Meter 30
 - Pressure 17
 - Pulse Counting 21
 - Resistance 19, 20
 - RTD 19
 - Switch Sensing 21
 - Temperature 19
 - Thermocouple 19
 - Voltage 18
- Memory 9
- Menu Button 5
- Meter 30
- Mobile Security Plus 75

N

- Numbers, Entering 22, 23
- Numeric Fields 6
- Numeric keypad 22

O

- Options
 - Security Tool 75
 - Software 13

P

- PC Communication 12, 14, 36
- Plant Structure 38, 39
- Power Button 4
- Power Management 4, 74
- Power Supply Connector 8
- Pressure Controllers 14, 86
 - Configuring 87

- Pressure Measurement 17
 - External Pressure Modules 17
 - Zeroing a Pressure Module 17
- Pressure Module
 - Zeroing 17
- Pressure Modules
 - Barometric 9
 - External 8
 - Internal 8
- Pressure Units
 - User Defined 79
- PROFIBUS PA™ 60
- PRT Sensors
 - Callendar van Dusen 81
 - Factor customization 83
 - ISO 90 81
 - Testing Custom Sensors 83
 - User Defined 80
- Pulse Counting 21
- Pulse Generation 27

Q

- Quick Access Buttons 34

R

- Ramping 34
- Recalibrating MC6 98
- Reference Junction 19
- Reference Junction Connections 28
- Regional Settings 74
- Resetting MC6 97
- Resistance Measurement 20
- Resistance Simulation 26
- Resolution 34

- Results (Calibration)
 - Deleting 48
 - Saving 43
 - Viewing 48
- Right side
 - Connectors 7
- RTD Measurement 19
- RTD Simulation 25

S

- Safety 90
- Saving Smart Transmitter
 - Configurations 71
 - Scaling 33
 - Security Tool 75
 - Servicing MC6 97
 - Settings 74
- Simulation (see also Generation)
 - Changing the simulated value 22
 - Resistance 26
 - RTD 25
 - Thermocouple 25
- Software Options 13
- Sounds 74
- Spinner 23
- Stability Test 33
- Standard Accessories 3
- Standby Mode 4
- Starting a Data Log 56
- Starting MC6 4
 - Stepping 34
 - User Defined 85
- Storing the Battery Pack 93
- Supply Voltage 18
- Switch Sensing 21
- Symbols
 - Alarms 33

T

Temperature Blocks.....	14
Temperature Controllers	86
Configuring	87
Temperature Measurement.....	19
Testing Leakage/Stability	33
Text Fields	6
Thermocouple Connections	28
Thermocouple Simulation	25
Tools	
Additional Info.....	34
Alarms.....	33
Damping	34
Function Info.....	34
Leak/Stability Test	33
Quick Access Buttons.....	34
Ramping	34
Resolution.....	34
Scaling	33
Stepping.....	34
Touch Screen Display.....	9
Trademarks.....	100
Transfer Functions	
User Defined.....	84
Transferring Data Log Results to a PC	58
Trimming a Fieldbus Instrument.....	67
Trimming a HART Instrument.....	68
Typographical conventions	3

U

Unpacking.....	3
Updating MC6's Firmware.....	97
USB Connectors	8
User Defined Calibration Points	85
User Defined Pressure Units.....	79
User Defined PRT Sensors.....	80

User Defined Steps.....	85
User Defined Transfer Functions	84

V

Viewing Smart Transmitter Configurations.....	72
Voltage Generation.....	24
Voltage Measurement.....	18
Volume of Sounds	74

W

Warnings	91
Charging the Battery Pack	93
Electrical.....	94
General	91
Lithium Polymer Battery Pack.....	92
Pressure Measurement.....	94, 95
Use of Communicator	61
WEEE	96

Z

Zeroing a Pressure Module.....	17
--------------------------------	----