

# Beamex POC8

## AUTOMATIC PRESSURE CONTROLLER



## User Manual

Dear user,

We have made every effort to ensure the accuracy of the contents of this manual. Should any errors be detected, we would greatly appreciate to receive suggestions to improve the quality of the contents of this manual.

The above notwithstanding, we can assume no responsibility for any errors in this manual or their eventual consequences.

We reserve rights to make modifications to this manual without any further notice.

For more detailed technical data about the Beamex® POC8 Automatic Pressure Controller, please contact the manufacturer.

© 2017 - 2018

**BEAMEX OY AB**

**Ristisuonraitti 10**

**FIN-68600 Pietarsaari**

**FINLAND**

**Tel +358 - 10 - 5505000**

**Fax +358 - 10 - 5505404**

**E-mail: sales@beamex.com**

**Internet: https://www.beamex.com**



This Warning symbol indicates that danger of injury for persons and the environment and/or considerable damage (mortal danger, danger of injury) will occur if the respective safety precautions are not taken.



This Caution symbol indicates danger for the system and material if the respective safety precautions are not taken.



This Notice symbol does not indicate safety notices but information for a better understanding of the facts.

# Contents

<b>General Information .....</b>	<b>1</b>
FCC Radio Frequency Emission Notice .....	1
Trademarks .....	1
Packaging for Shipment .....	1
<b>Safety Notices .....</b>	<b>2</b>
User Responsibilities .....	2
General Safety Notices .....	2
Warnings and Caution Notices .....	3
<b>General Description .....</b>	<b>4</b>
Features .....	4
Turning On .....	5
Front Panel .....	6
Power Switch .....	6
USB Port .....	6
Display .....	7
Chassis Assembly.....	8
<b>Specifications .....</b>	<b>9</b>
Measure Specification.....	9
Control Specifications .....	9
General Specifications .....	10

<b>Installation .....</b>	<b>11</b>
Unpacking the Instrument .....	11
Dimensions in mm / inches .....	12
Mounting .....	13
Rear Panel .....	13
Pressure Connections .....	13
Supply Port .....	14
Exhaust Port .....	14
Vent Port .....	14
Measure/Control Port .....	14
Reference Port .....	14
Barometric Reference Port .....	14
Remote Communication Connections .....	14
Power Up .....	14
 <b>Local Operation and Setup .....</b>	 <b>15</b>
General Operation .....	15
Setup 15	
Display Screen Features .....	15
Initial Setup .....	16
Contact and Version Information View .....	16
Language Selection .....	16
Settings Views' Parameter Inputs .....	17
Main Functions .....	18
Home View .....	18
Settings View .....	26
Control Settings .....	30
Display Settings .....	35
Programs .....	37
Favorites View .....	38
Information View .....	39
Troubleshooting View .....	40
Remote Settings View .....	41
Step Settings View .....	43
Leak Test .....	45
Burst Test .....	46
Service View .....	47
Unlocked Service View .....	48

<b>Remote Operation .....</b>	<b>49</b>
Command Set .....	49
Operation with Beamex calibrators .....	49
IEEE-488.....	50
IEEE-488.2 Commands .....	50
Ethernet .....	51
USB device (Virtual Serial Port).....	51
Serial.....	52
Serial Cable Requirements .....	52
Command and Query Format .....	53
Command Set Definitions .....	53
Output Formats .....	54
Commands and Queries .....	55
Beamex default command set .....	55
Units Command Syntax for Measurement Units.....	62
Error Codes.....	63
SCPI Commands and Queries.....	63
GPIB Capability Codes .....	66
GPIB Capability Codes .....	66
Interface Functions .....	67
USB Software Upgrade.....	68
<b>Options .....</b>	<b>69</b>
Barometric Module.....	70
Gauge Pressure Emulation.....	70
Absolute Pressure Emulation.....	70
Emulation Mode Accuracy .....	70
Calibration of the Barometric Module.....	70
Specifications of the Barometric Module.....	70
Additional measurement modules .....	71
Secondary measurement module installation .....	71
Bench Mounting Kit.....	71
Fittings .....	71
Re-calibrating.....	72
Dirt and Moisture Trap .....	72

**Maintenance..... 73**

- Removing the measurement module ..... 73
- Troubleshooting ..... 74

**Calibration..... 75**

- Environment..... 75
- Pressure Standards ..... 75
- Media ..... 75
- Service View (unlocked) ..... 76
- Calibration Data ..... 77
- One Point Calibration..... 77
- Two Point Calibration..... 78
- Linearization..... 79
- Head Pressure ..... 81

**Appendix ..... 82**

- Measurement Units ..... 82
- Conversion Factors, PSI ..... 83
- Conversion Factors, millitorr ..... 84
- Conversion Factors, Pascal ..... 85
- Installing POC8 to MCS200 Module Rack..... 86
  - Installation Procedure ..... 87
  - Connections ..... 88

# Feedback

We want to improve our products and services constantly. Therefore we'd like to know Your opinion of the product You use. Please spend a moment of Your valuable time in filling this form. All respondents will receive a surprise gift in return.

Certain questions can be answered immediately after receiving the product. Others require some use of the product before You are able to answer them. The best way to fill the form is to answer the items as it applies, and send the form to us when all items are answered. There are however no definite restrictions; fill in the form when you feel like it (all items need not be answered). Then send it to Beamex using one of the possibilities listed below.

Mail: **Beamex Oy, Ab**  
**Quality Feedback**  
**P.O. Box 5**  
**68601 Pietarsaari**  
**FINLAND**

Fax **+358 - 10 - 5505404**  
*Only the next page need to be faxed to us.*

Internet: **<https://www.beamex.com>**  
*A similar form is available as a web page*

E-mail: **[support@beamex.com](mailto:support@beamex.com)**  
*Refer to the numbered items on the next page in Your e-mail message.*

1. Name of the product you give feedback of: \_\_\_\_\_

2. Serial number and software version number (if applicable) \_\_\_\_\_

\_\_\_\_\_

3. Any comments when receiving the product. Did the package contain all required items and was it as expected?

\_\_\_\_\_  
\_\_\_\_\_

4. For how long have you been using the product? \_\_\_\_\_

5. How helpful was the manual in using the product?

*(Tick a box in the percentage scale below)*

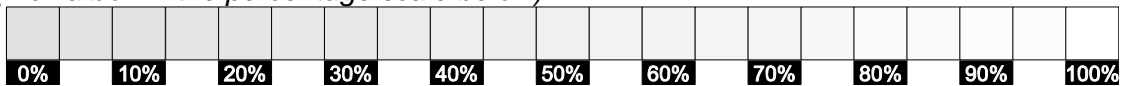

6. How well did the product suit your needs?

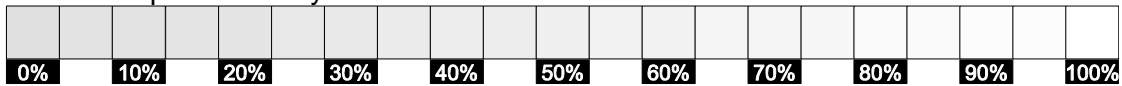

7. How satisfied are you with the product?

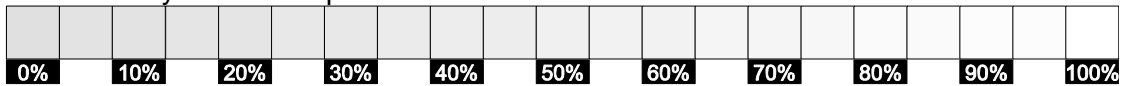

8. Did anything in the product exceed your expectations? In that case, what was it?

\_\_\_\_\_  
\_\_\_\_\_

9. Did anything in the product disappoint you? In that case, please specify.

\_\_\_\_\_  
\_\_\_\_\_

10. Any ideas You want to propose to Beamex so that we can improve our products, operations and/or services.

\_\_\_\_\_  
\_\_\_\_\_

---

Title & Name: \_\_\_\_\_

\_\_\_\_\_

Address: \_\_\_\_\_

\_\_\_\_\_

\_\_\_\_\_

\_\_\_\_\_

- Please contact me concerning the Feedback I have given.
- I want to receive more information on Beamex products.



# General Information

---

## FCC Radio Frequency Emission Notice

This equipment has been tested and found to comply with the limits for a Class A digital device, pursuant to part 15 of the FCC Rules. These limits are designed to provide reasonable protection against harmful interference when the equipment is operated in a commercial environment. This equipment generates, uses, and can radiate radio frequency energy and, if not installed and used in accordance with the instruction manual, may cause harmful interference to radio communications. Operation of this equipment in a residential area is likely to cause harmful interference in which case the user will be required to correct the interference at his or her own expense.

Use shielded cables to connect external devices to this instrument to minimize RF radiation.

---

## Trademarks

Beamex is a registered trade mark of Beamex Oy Ab.

---

## Packaging for Shipment

If the product must be shipped to a different location or returned to Beamex for any reason through a common carrier it must be packaged properly to minimize the risk of damage.

The recommended method of packing is to place the instrument in a container, surrounded on all sides with at least 100 mm / four inches of shock attenuation material such as styrofoam peanuts.

# Safety Notices

---

## User Responsibilities

To ensure safety, the user must make sure that:

- The system is used properly, no dangerous media are used and that all technical specifications are observed.
- The system is operated in perfect operating condition.
- This operation manual is legible and accessible to the user at the system's location.
- The system is operated, serviced and repaired only by authorized and qualified personnel.
- The operator receives instruction on industrial safety and environmental protection, and is knowledgeable of the operating instructions and the safety notices contained therein.

---

## General Safety Notices



**Notice**

The system should only be operated by trained personnel who are familiar with this manual and the operation of the instrument.



**Warning**

A condition for trouble-free and safe operation of this system is proper transport, proper storage, installation, assembly and proper use as well as careful operation and maintenance.

Any operation not described in the following instructions should be prohibited. The system must be handled with care required for an electronic precision instrument (protect from humidity, impacts, strong magnetic fields, static electricity and extreme temperatures). Do not insert any objects into the instrument.

The system is powered via the power cable with a voltage that can cause physical injury. Even after disconnecting the system from the power supply, dangerous voltages can temporarily occur due to capacitance.

Extreme care must be taken with pressure connections when using hazardous or toxic media.

Repairs must only be performed by authorized service personnel.



**Notice**

Additional safety notices are found throughout this manual.

---

## Warnings and Caution Notices



**HIGH PRESSURE!** High pressure gases are potentially hazardous. Energy stored in these gases and liquids can be released suddenly and with extreme force. High pressure systems should be assembled and operated only by personnel who have been trained in proper safety practices.



**NOT EXPLOSION PROOF!** Installation of this instrument in an area requiring devices rated as intrinsically safe is not recommended.



**POSSIBLE INJURY!** The tubing, valves, and other apparatus attached to the gauge must be adequate for the maximum pressure which will be applied, otherwise physical injury to the operator or bystanders is possible.



**USE THE PROPER PRESSURE MEDIUM!** Use only clean, dry, non-corrosive gases. This instrument is not designed for oxygen use.



**HIGH SOUND LEVELS!** Pressures from 70 bar / 1000 psi and up can generate sound levels above 80dbA for brief period when they are exhausted directly to atmosphere. A muffler/ snubber is installed in the vent port. Removal of muffler/ snubber will allow for sound levels to exceed 80dbA.



As with most sensitive electronic equipment, switch the power switch off before connecting or disconnecting to a power source to prevent data loss. Do not position the equipment so that it is difficult to disconnect the power jack.



**WARNING:** Detachable main power supply cord with inadequate ratings should not be used. See Section 4.0 - Specifications for power ratings.



**CAUTION! ESD PROTECTION REQUIRED.** The proper use of grounded work surfaces and personal wrist straps are required when coming into contact with exposed circuits (printed circuit boards) to prevent static discharge to sensitive electronic components.

Additional Warning and Caution notices are found throughout this manual.

# General Description

POC8 is a bench top or rack mounted Pressure Controller used for test and calibration of mechanical pressure gauges, sensors, transducers, transmitters and any pressure related devices where time to set point is a critical requirement.

POC8 can have up to two highly stable precision pressure measurement modules and an optional barometric module.



*POC8 Desk top version.*

---

## Features

- Up to two highly stable, temperature compensated, internal pressure measurement modules.
- Broad operating pressure range from -1 barg / -15 psig to 210 bar / 3 045 psig
- Accuracy 0,02% FS.
- An optional removable / interchangeable internal high accuracy barometric module providing gauge pressure emulation for absolute ranges and absolute pressure emulation for gauge ranges.
- Auto-ranging between the two measurement modules to provide seamless transition between all ranges.
- 7" Color LCD display with touch screen.
- Leak test and burst test.
- Multiple languages; change the language for on-screen text and number/date formats by simply touching one of the "national flag" icons available in the setup screen.
- Desk top or bench mount
- Local Operation, or command and read remotely.

## Turning On

Apply power to the power connector on the rear of the instrument with the included power cord, remove any plastic plugs from the rear panel pressure ports, and press the power switch to ON. The system will go through an initialization process, which takes about 30 seconds, and then a display will appear similar to the screen shown below.



*Power button highlighted.*



**Caution**

### Earth Ground!

Any power adaptors or surge protection devices that negate the protective earth ground should not be used. The power cord must be accessible and contain a protective earth ground.



**Caution**

### Ventilation!

Do not block airflow to ventilating fans located on rear of instrument.

To see information about the configuration of your new POC8, touch the Next Page Button [▶] then the Information view icon [ⓘ] on the menu and a window will appear listing the Beamex customer service contact, model number and the modules that are installed. Press the Previous Page Button [◀] then the Home view [🏠] to return to the main screen.

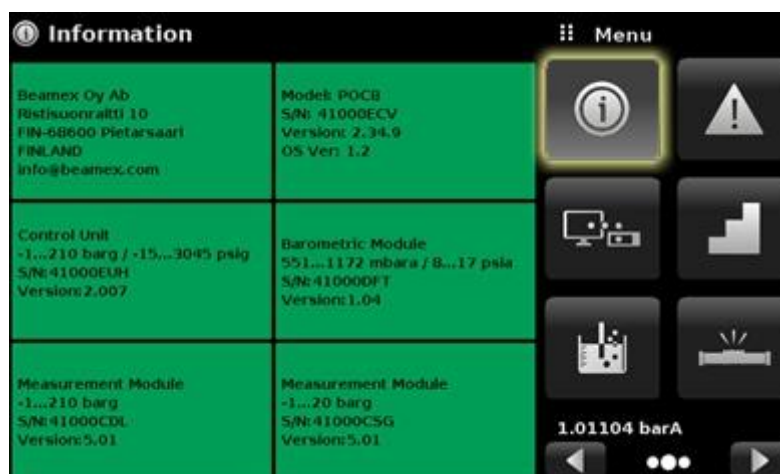

*Information view button highlighted.*

---

## Front Panel

The POC8 front panel includes a 7" color LCD display with touch screen. Operator input is accomplished by pressing the words or symbols and the button icons presented on the display. There is a single discrete on/off button and a USB port on the right hand side.



## Power Switch

The power switch is a two-state device with an action similar to that of a ball point pen. Push the button with enough force to latch it in to turn the unit ON. Push it again to release it to turn the system OFF.



**Notice**

**If power to the instrument is interrupted while ON it will shut down until the power is restored, then immediately resume operation.**

## USB Port

The front panel USB port acts like the Host USB and is intended for software upgrades.

## Display

The display is made up of two sections. In the main screen (“Home view”), the left side shows the operating screen with the control channel. The control channel displays the active pressure reading, units, mode (absolute or gauge), active range of the internal measurement module, pressure control setpoint, a bar graph (if enabled), a zero or tare button (if enabled) and any auxiliary displays that have been chosen. The right side of the screen has button icons for general instrument settings, control settings, display settings, program settings, favorites plus a “Next Page” button [ ▶ ] that, when pressed, shows a second and third page of icons for information, troubleshooting, remote communication, step setting, leak test, burst test and service applications.

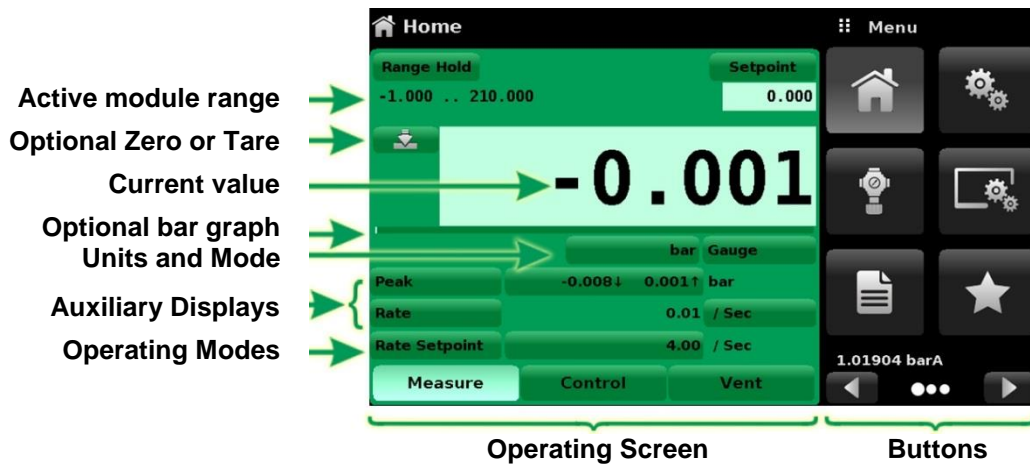

**Buttons, Labels and Windows:** The touch screen has many buttons with relevant graphic icons or text which, when pressed, will open a related window where changes can be made or information viewed. Some of these buttons will toggle from one state to another, others present choices or display a numerical data entry screen. Text or icons that are displayed, but do not respond to being touched, are called labels or windows. Operators will quickly become accustomed to the particular characteristics of the frequently used buttons.

**Main Screen:** The main screen or “Home view”, appears after power-up. This screen contains the operating screen and buttons. It will remain as configured after a power cycle.

**Operating screen:** The operating screen (left side of the screen) contains information relevant to the measurement. Up to three auxiliary displays can be shown simultaneously along with the current pressure value. The operating mode of the instrument can be selected and changed in this screen between “Measure”, “Control” and “Vent”.

---

## Chassis Assembly

The chassis assembly is the housing for the system. The pressure measurement modules are self-contained inside the chassis and can be replaced using basic hand tools. The picture below shows the top view of the chassis with the cover removed.

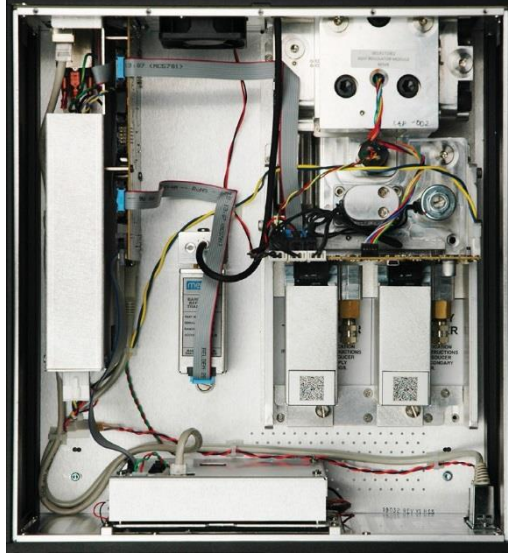

*Chassis assembly.*

The heart of the chassis assembly is referred to as the “Controller Unit”. They are available in three variations depending on the working pressure range:

- -1 to 10 barg / -15 to 150 psig
- -1 to 100 barg / -15 to 1 500 psig
- -1 to 210 barg / -15 to 3 045 psig

Each chassis includes platforms for up to two high performance pressure measurement modules, which are traceable to international standards. Both of these modules can be used in conjunction with the highly stable controller unit to produce a precise output. Each measurement module includes its own on-board compensation and calibration data so that any module can be replaced in the instrument without requiring a recalibration.



*Pressure Measurement Module.*



# Specifications

## Measure Specification

Specification	POC8
Pressure ranges / Pressure Measurement Modules	Barometric, measuring range: 552 ... 1 172 mbar abs / 8 ... 17 psi abs* ± 350 mbarg / ± 5 psig ± 1 barg / ±14.5 psig -1 to 6 barg / -14.5 to 87 psig -1 to 20 barg / -14.5 to 290 psig -1 to 100 barg / -14.5 to 1 450 psig -1 to 210 barg / -14.5 to 3 045 psig Special range within -1 to 210 bar / -14.5 to 3 045 psi  * The barometric module can be used to switch pressure types, absolute <=> gauge. With gauge pressure modules the measuring range of the module must begin with -1 bar / -15 psi in order to carry out a complete absolute pressure emulation.
1 year uncertainty*	0.02 % of span. For barometric module : 0.02 % of reading * Uncertainty includes reference standard uncertainty, hysteresis, nonlinearity, repeatability and typical long term stability for mentioned period (k=2).
Pressure types	Absolute and gauge or bi-directional ranges
Recommended Calibration Interval	365 days
Reading rate	33 readings/second
Wetted Parts	Aluminum, Brass, 316 and 316L stainless steel, Buna N, FKM/FPM, PCTFE, PEEK, PTFE, PPS, PAI, Glass-filled Epoxy, RTV, Silicone, Silicone grease, Urethane

## Control Specifications

Specification	POC8
External Source Requirements	10% over range or 1.38 bar / 20 psi over the highest measurement module, whichever is less: min. 0.34 bar / 5 psig max. 211 bar / 3 060 psig
External Exhaust Requirements	Vacuum source required for sub atmospheric control
Stability of Controlled Pressure	0.005% of full scale of the active range, typically better than 0.002% of span after 10 sec after displaying stable pressure
Minimum Control Pressure	0.05% FS or 1.72 mbar / 0.025 psi over exhaust pressure, whichever is greater
Maximum Control Pressure	Available Controller Units (one of the listed pre-installed inside the unit): -1 to 10 barg / -15 to 150 psig -1 to 100 barg / -15 to 1 500 psig -1 to 210 barg / -15 to 3 045 psig
Pressure Control Modes	Fast, medium, slow and variable
Pressure Control Rates	0.05% FS/sec to 10% FS/sec into a 50 ml volume
Stability of Rate Control	+/- 10% of rate setpoint, down to +/- 0.001% of span of active range per sec
Control Time	10 s (regarding a 10% FS pressure increase in a 50 ml test volume)
Overshoot	< 0.3% FS in fast control mode (typical < 0.01% FS in slow control mode)
Supply Consumption	< 70.8 l / < 2.5 standard cubic feet per hour in steady-state control
Test Volume	0 to 1000 ml; The controller auto compensates volumes from 0 to 500 ml

## General Specifications

Specification	POC8
Instrument Version	Standard: desktop case Optional: bench mounting kit
Dimensions	See technical drawings
Weight	Approximately 12.7 Kg / 28 lbs. with all internal options (desktop case)
Warm up Time	Approximately 15 minutes
Screen	7" color LCD display, resistive touchscreen
Resolution	4 ... 6 digits depending on range and units
Pressure units: Metric	Metric: mbar, bar, Pascal, hPa, kPa, MPa, mmH <sub>2</sub> O@4°C, cmH <sub>2</sub> O@4°C, mH <sub>2</sub> O@4°C, mmH <sub>2</sub> O@20°C, cmH <sub>2</sub> O@20°C, mH <sub>2</sub> O@20°C, mSV, mmHg@0°C, cmHg@0°C, mHg@0°C, Torr, mTorr, Dyn/cm <sup>2</sup> , g/cm <sup>2</sup> , kg/cm <sup>2</sup>  Imperial: psi, inHg@0°C, inHg@60°F, inH <sub>2</sub> O@0°C, inH <sub>2</sub> O@20°C, inH <sub>2</sub> O@60°F, ftH <sub>2</sub> O@4°C, ftH <sub>2</sub> O@20°C, ftH <sub>2</sub> O@60°F, inSW, Osi, psf, tsi tsf, ftSW, Torr, mTorr, % of range, atm
Pressure units user defined	2 (multiplier from psi or Pascal)
Languages	English, French, German, Italian, Spanish, Polish, Portuguese, Russian, Chinese, Japanese, Korean
Measurement Filters	Off, Low, Normal (default), High
Pressure ports	4 ports with 7/16" - 20 F UNF including adapters to Beamex low/high pressure hoses (vacuum and pressure supply hoses are included) Optional Barometer: 10-32 UNF female port
Filter Elements	Filter element (40 micron) included in each pressure port
Permissible Pressure Media	Clean dry non-corrosive gases (ISO8573-1:2010 Class 5.5.4 or better)
Overpressure Protection	Safety relief valves are set to protect each internal pressure module
Power Supply	100 – 120 or 200 - 240 VAC, 50 Hz / 60 Hz, 120 VA Max
Storage Temperature	0 ... 70 °C / 32 ... 158 °F
Operating Temperature / Compensated Temperature Range	15 ... 45 °C / 59 ... 113 °F
Humidity	5 ... 95 % r. h. (relative humidity, non-condensing)
Mounting Position	Horizontal
Digital Interface	Standard: Ethernet, IEEE-488, USB, RS-232. Only the USB interface is supported with Beamex products.
Response Time	100 ms
EU Declaration (CE mark)	Conformity certificate
Calibration	Accredited Calibration Certificate included



This is class A equipment for emissions and is intended for use in industrial environments. In other environments, e.g. residential or commercial installations, it can interfere with other equipment under certain conditions. In such circumstances the operator is expected to take the appropriate measures.

# Installation



**READ THESE INSTRUCTIONS BEFORE INSTALLATION!**

---

## Unpacking the Instrument

In addition to functional testing, each unit is inspected for appearance prior to leaving the factory. Upon receipt, please examine the instrument for shipping damage. Report any apparent damage to the carrier immediately.

The following items are included in the standard delivery:

- POC8 Automatic Pressure Controller
- Calibration certificate
- This User Guide
- Power Cord
- Vacuum connection hose and connectors
- Supply pressure connection hose and connectors

---

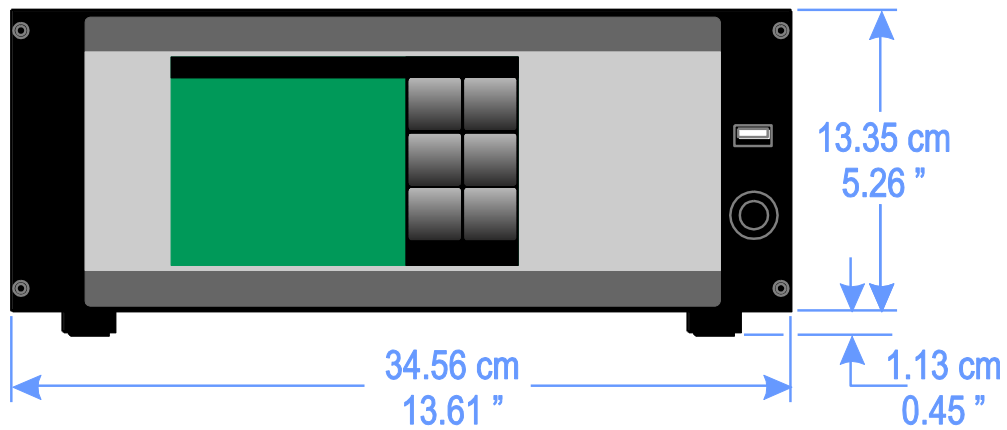
**Dimensions in mm / inches**

*Front view, standalone instrument.*

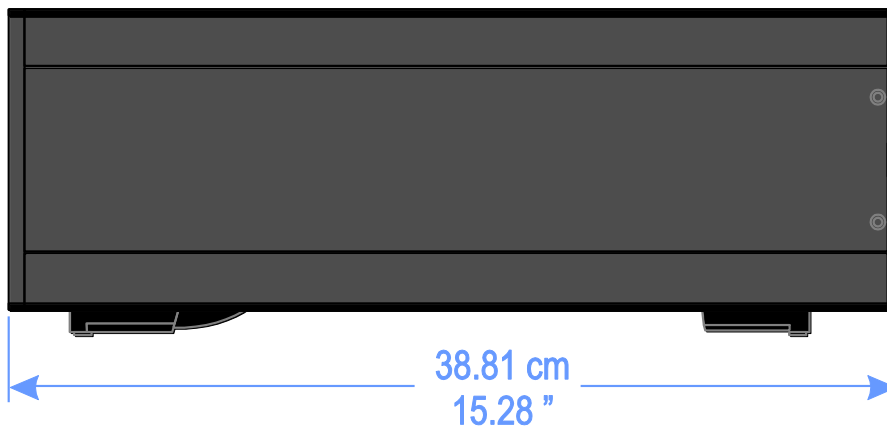

*Side view, standalone instrument.*

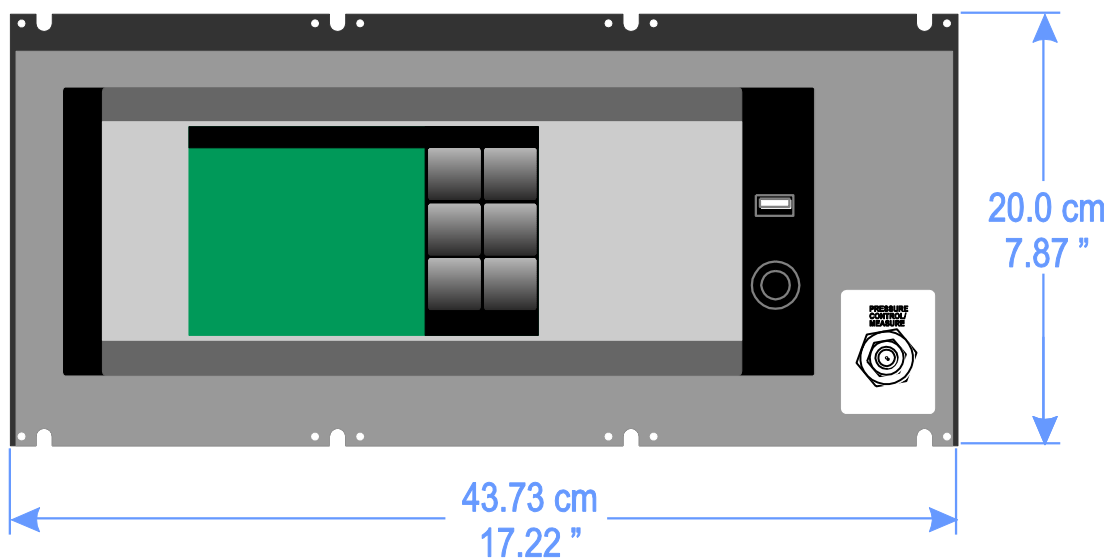

*Front view, rack mounted instrument.*

## Mounting

The instrument can be set up on a desk top or it can be rack-mounted. Rack mount hardware is optional on the POC8 (see chapter **Dimensions in mm / inches** on page 12 and **Options** on page 69).

The measurement modules are relatively insensitive to tilt and vibration. However to further assure stability and accuracy, avoid mounting the instrument on surfaces subject to excessive motor or machinery vibration.

## Rear Panel

Five pneumatic pressure ports are located across the rear panel. Any instrument containing sub-atmospheric pressure ranges needs a vacuum pump to be connected at the exhaust port. The instruments with pressures above or at atmospheric pressures will have the exhaust port open. Next to the ventilation fan is a 10-32 UNF fitting which is connected to the barometric module if installed. Positioned on the right side is a remote communication connections; RS-232, Ethernet, IEEE-488, USB along with the USB host connection.



Rear Panel.

## Pressure Connections



The pressure connections must be installed according to the following instructions, observing the relevant regulations. The installation is to be performed by trained, authorized personnel, knowledgeable in the safety regulations for working on pneumatic/hydraulic systems.

**Five pressure connections are on the rear panel. Plugged connections are not used.**

All pressure ports on the rear apart from the Vent Port are female 7/16" - 20 F UNF. Beamex provides pressure connectors and vacuum and supply hoses with the device. Pressure hoses for output pressure are optional accessories. Do not use sealant on fittings sealed with an o-ring. The integrity of each seal is particularly important since even microscopic leaks can cause errors in pressure measurements.

## Supply Port

The pressure supplied to the pressure connection labeled “Supply” should be approximately 10% higher than the full scale of the highest pressure transducer installed in the controller (see chapter **Contact and Version Information View** on page 16).

## Exhaust Port

The pressure connection labelled “Exhaust” is for the vacuum supply. In a gauge pressure version it can be left open to atmospheric pressure.

## Vent Port

The pressure connection labelled “Vent” is the exhaust port where the system pressure is vented to the atmosphere under certain conditions. This port has a breather vent installed that acts like a muffler. Leave this port open.

## Measure/Control Port

The Measure/ Control port (when in the Control mode) supplies pressure that is precisely controlled by the controller. In the Measure mode a pressure applied to the Measure/Control port is measured by the internal measurement modules.

## Reference Port

The pressure connection labeled “Reference” is the reference port, it is available to connect to the reference side of the sensor. This port is normally left open to atmosphere but may be connected to a stable reference pressure. For an absolute pressure measurement module this port can be plugged.

## Barometric Reference Port

The Barometric Reference port is connected to the optional internal barometer module and should be left open to atmospheric pressure.

## Remote Communication Connections

See chapter **Remote Operation** on page 49 for connections and commands for operation over IEEE-488, Ethernet, USB or RS-232 ports.

## Power Up

Apply power to the power connector on the rear of the instrument using the power cord included, and switch the power switch on the front of the unit ON. The instrument will go through an initialization process and system check. As soon as the system check is completed the system will default to a screen similar to the one shown in chapter **Display Screen Features** on page 15. The main screen may be configured in many different ways but initially it will be in a default configuration. Subsequently, the unit will power up in the configuration that it was in when last powered off. Allow at least 15 minutes of warm up before performing critical pressure measurements.

# Local Operation and Setup

## General Operation

This section describes the procedures for operating the POC8 from the front panel. Instructions for operating the device remotely from an external computer are covered in **Remote Operation** on page 49. By following the procedures provided in these two chapters and chapter **Calibration** on page 75, you can expect your POC8 to deliver maximum accuracy and dependability for many years of useful service.

## Setup

Configuration is achieved by changing settings accessed through the buttons on the right. Local operation is accomplished by observing the data presented in the display. The appearance and functionality of the display can be changed by pressing corresponding button for the related function. After a button/function has been chosen, a set of related parameters will appear. After choosing one of these parameters, a set of selections related to that parameter will appear on a data entry keypad. The desired selection or data can be entered here.

## Display Screen Features

The screen shown below provides an overview of the features shown on the display after initialization. The left side of the display contains the area where information is displayed (in this case the Home view) and the right side contains the buttons for settings and other functions. A zero or tare button, bar graph and auxiliary displays (rate set point, control rate, peak values & units) will appear in the Home view, if activated. All of the screen features are described in more detail throughout this manual. The active button is represented in a lighter gray color as compared to the other buttons.

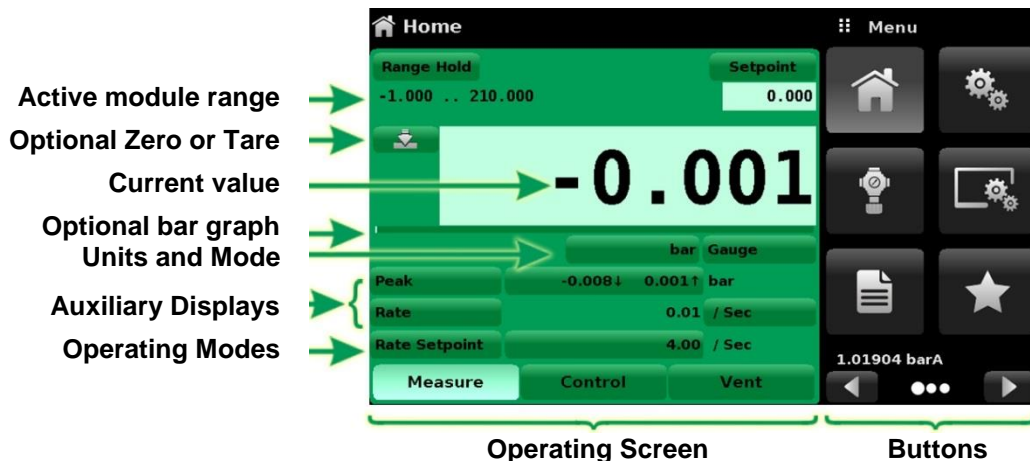



*Display Screen Features.*

## Initial Setup

Chapters **Contact and Version Information View** and **Language Selection** further down on this page are provided first so that the operator can initially check the information screen to verify the installed components and to change the language if needed.

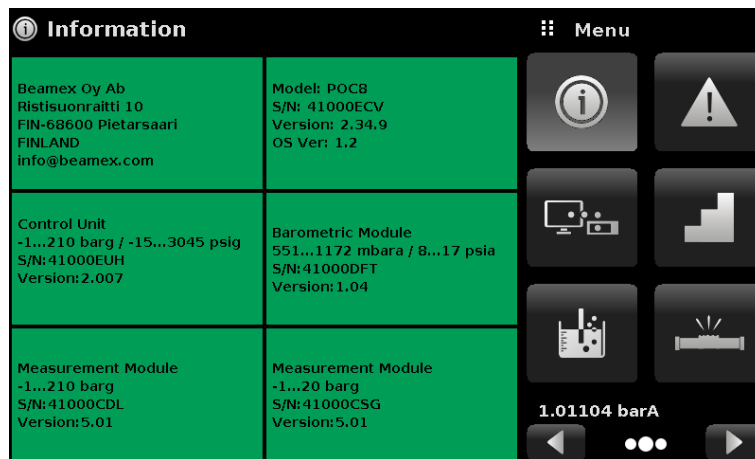

### Contact and Version Information View

Navigate to the view selection area by pressing the Next Page button [  ] at the right bottom under the buttons on the right. This gives access to the second page of the button selection area. Press the Information view button [  ] to display Beamex contact, installed pressure control unit and pressure measurement modules along with instrument and software version information.



Information.

### Language Selection

Pressing the settings button [  ] will open a screen where the language, display brightness, volume, user base units/multiplier and configuration loading/saving, can be changed. The current language selections available are shown in the table below. Additional language choices will appear on the screen after pushing the current language selection and then Next Page button [  ]:

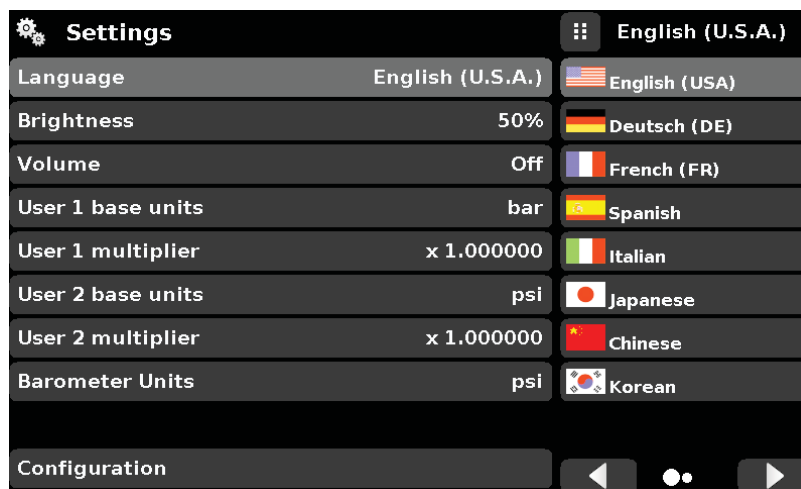

Language Selection.



## Settings Views' Parameter Inputs

The Settings view's input area on the right one fourth of the screen (see chapter **Display Screen Features** on page 15) is the area where setup, information, calibration, service and other functions can be chosen. Multiple pages of selections can be accessed by pressing the Next Page button [▶] or by pressing the Previous Page button [◀]. A series of horizontally placed circles on the bottom right represents the number of pages and indicate the active page by a larger circle. As a function is chosen, related parameters will appear on the left side of the screen along with the name of the function, and a reduced size icon in the top title section. When a parameter is chosen, related selections, sliding scales or a data entry key pad will appear in the input area on the right where the buttons were previously displayed. An example of each type of input is shown below. To return to the main view's buttons, simply press the Menu button [☰] above the input area. The purpose and use of each selection and menu is intuitively apparent and will become second nature with minimal exposure to the menu structure.

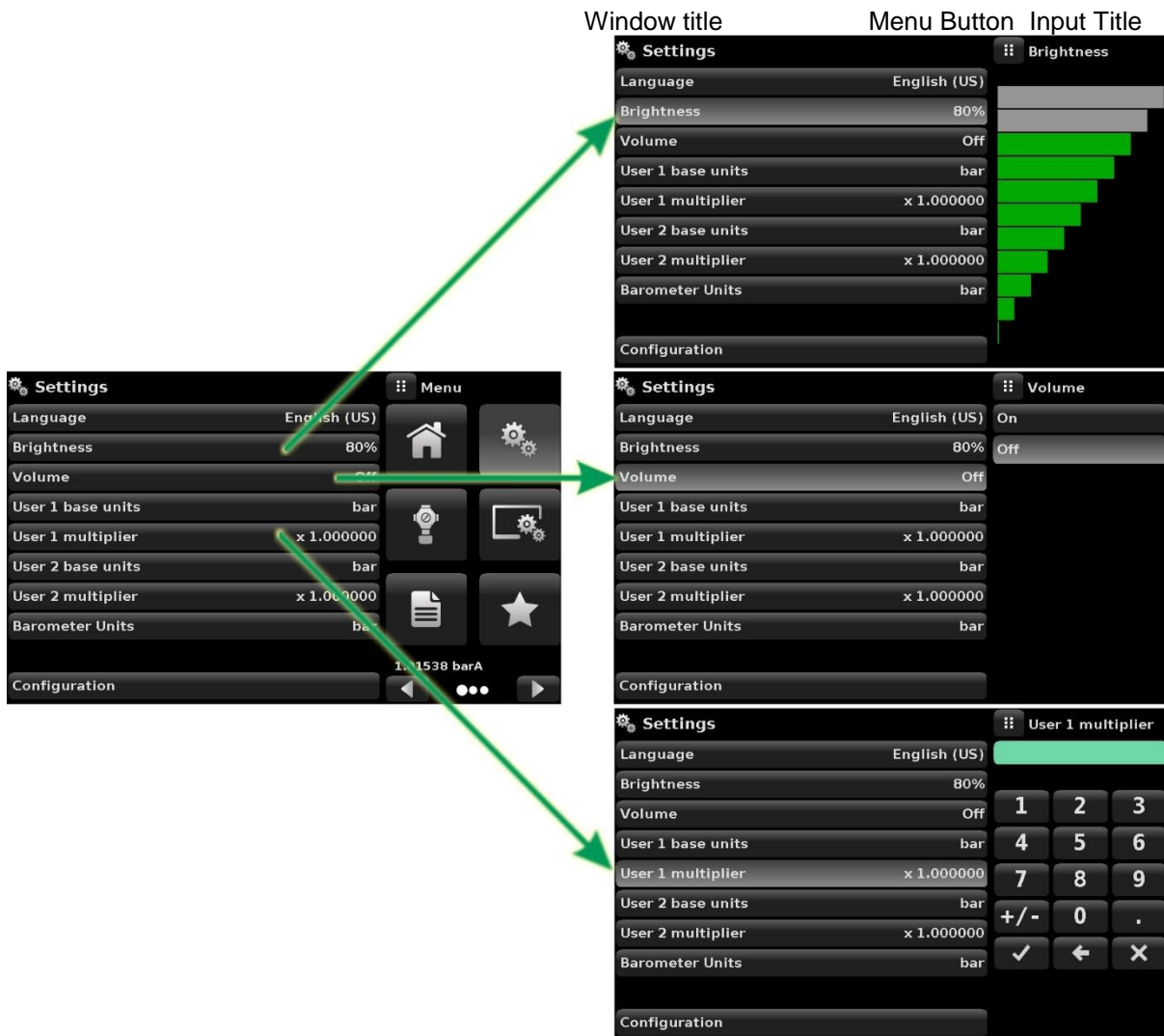

Settings Views.

## Main Functions

### Home View

The Home view [  ] is the normal operation screen. This view is different from the others in that it is not used to setup the configuration but is used to monitor the pressure applied to the installed measurement modules and the device under test through the measure / control port.

The "Home view" picture shows the basic Home view in an instrument. The user can change the display to show multiple auxiliary displays by pressing the auxiliary button on the left corner of the screen ("Single channel display" picture). The Units button is always displayed. When the Units button is pressed a selection of imperial and metric units will be displayed on the right ("Pressure units" picture); notice that the Units button has a lighter background when the selection menu is active. If a barometric reference is installed, the Mode button, described below, will toggle from Gauge to Absolute mode when pressed.

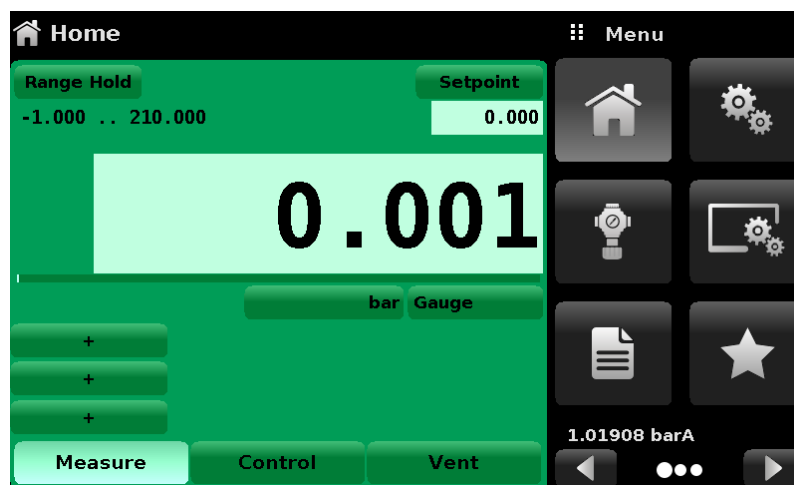

Home view.

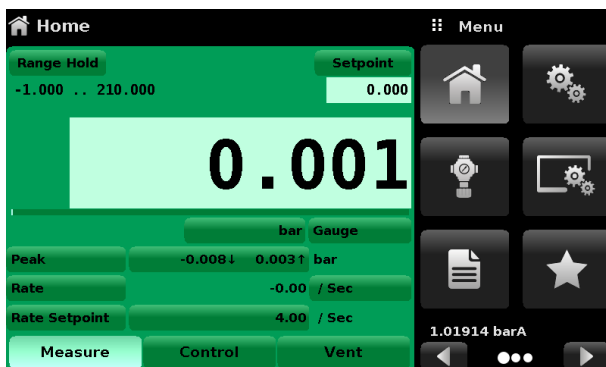

Single channel display.



Pressure units.

## Range Hold / Autorange

The Range Hold / Autorange button allows the user to select the active range. By clicking the Range Hold button, the user can select the active measurement module from the primary and secondary modules or utilize the “Autorange” feature to let the instrument automatically select the active range based on the current pressure value.

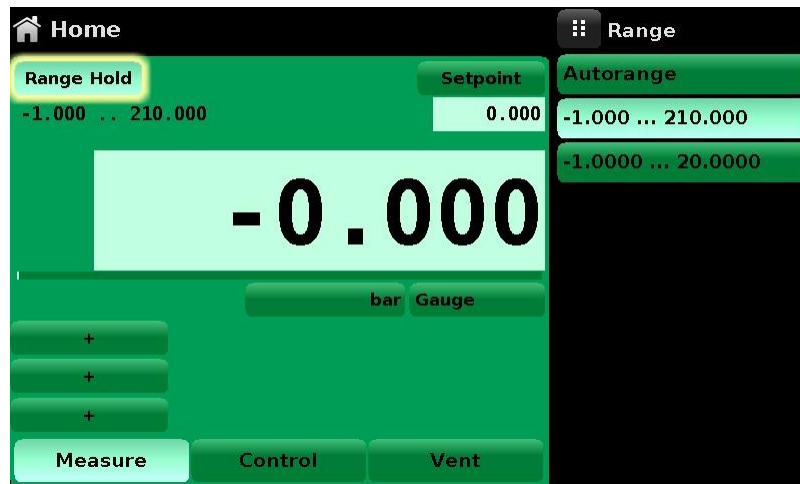

*Range Hold button highlighted.*

## Control Setpoint

The Setpoint button allows the user to enter the desired pressure value to be controlled by the POC8. There are multiple ways of entering the control setpoint; numeric keypad, step increments, percentage entry, digital step or a program data entry. These methods can be accessed by the user by pressing the “Setpoint” button and the various setpoint entry methods can be navigated with the Next Page [ ▶ ] and Previous Page [ ◀ ] buttons.



*Setpoint button highlighted.*

## Numeric Keypad

The first entry method provides 10 digits for numeric entry, plus the decimal point and a sign key (see picture below). The sign key [+/-] will toggle between positive and negative values. Each stroke on the key pad will echo in the blue input value window above the pad. A change between plus and minus values [+/-] can be entered at any time during the string entry. Pressing the Enter [ ✓ ] button will accept the value and it will become the setpoint.

If the input window holds an illegal value when the Enter button is pressed the system will respond with an error tone and the entry will turn red. When that happens determine the cause of rejection, delete the entry using the Delete [ ✕ ] button and then enter a valid number. The setpoint can only be entered within the minimum and maximum control range set in chapter **Control Limits** on page 33. These limits are shown above the numeric entry keypad.

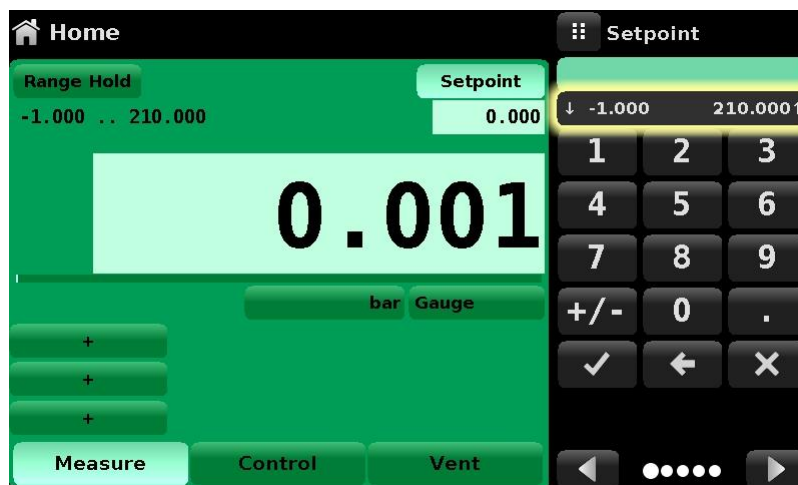

*Numeric Keypad Setpoint Entry. Min. & Max. setpoint values highlighted.*

## Step Increments

The second entry method allows the user to enter the setpoint in the same way as the Numeric Keypad by keying in the value and then pressing the Enter [ ✓ ] button. The user can then enter the desired value of step increment and press the Step Up [ ▲ ] or Step Down [ ▼ ] button, without pressing the Enter button. This number will then be used to decrease or increase the existing setpoint value. Subsequent touches of the Step Up or Step Down button will continue to increase or decrease the setpoint by the step value. If the Enter button is pressed the newly entered value will register as a new setpoint value on the Home Screen rather than a step value.

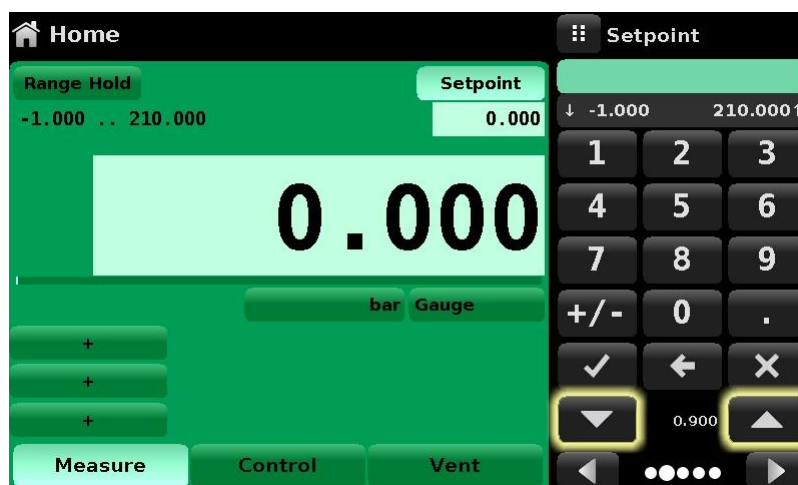

*Numeric Keypad Setpoint Entry. Step increment buttons highlighted.*

### Percentage Entry

The third entry method is the Percentage Entry method (see leftmost picture below) which allows the user to select a setpoint value as a percentage of the pressure range of device under test (DUT). The user can choose between various percentage values by clicking on the desired button. The setpoint will instantly change to the selected percentage value of the DUT. The user can also configure the minimum and maximum pressure values of the DUT by clicking the button displaying pressure range. This would take the user to the Step Settings view (see rightmost picture below) which is explained in section Step Settings.

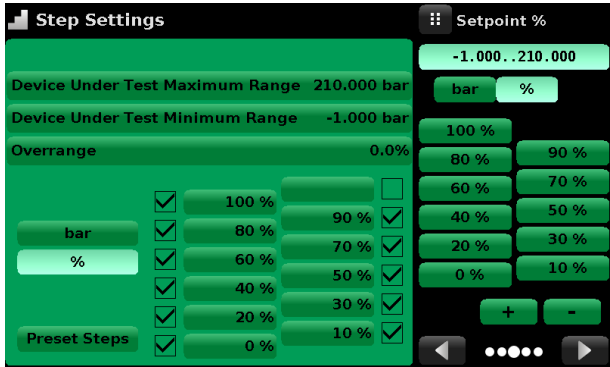

Percentage Entry window.



Entering maximum range.

### Digital Step Entry

The fourth entry method is the Digital Step data entry method. This method allows the user to increase or decrease the setpoint value by one digit at a time. The digit to be changed can be selected from a string of five zeroes (0) and one green numeral one (1) by sliding a finger across the zeroes and converting the desired digit to a green 1. The right most digit in the Digital Step corresponds to the least significant digit of the setpoint. Each digit of the setpoint can then be increased or decreased by pressing the Up [ ▲ ] or Down [ ▼ ] button.

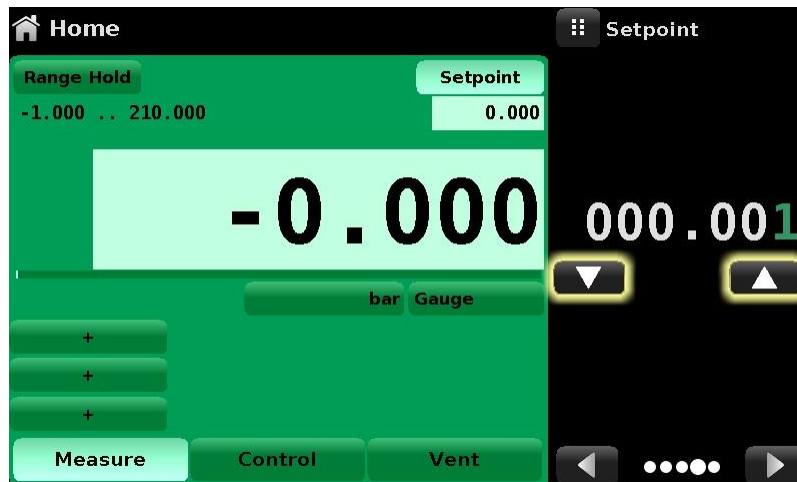

Digital Step Entry.

### Program Data Entry

The fifth entry method is through the automated Programs stored in the memory. The Program Player allows the user to select one of the stored Programs and use it for setpoint entry. A Program can be chosen by using the Up [ ▲ ] or Down [ ▼ ] buttons. After selecting the desired program, press the Play [ ▶ ] button to start the program. More information on the Program Player and how to create/ edit programs is available in chapter **Programs** on page 37.



Program Data Entry.

### Units and Pressure Type

The Units button is always displayed. When the Units button is pressed a selection of imperial and metric units will be displayed on the right (rightmost picture below). The pressure Type button is only active if there is an optional barometer module installed. Otherwise, the Type button becomes a label (leftmost picture below) indicating the native pressure type of the channel (absolute or gauge). When an optional barometer module is installed, a native gauge module can emulate absolute pressure using the barometric reference. Alternatively, a native absolute module can emulate gauge pressure. Emulation can be activated simply by pressing the pressure Type button.

Pressure Units button      Pressure Type button



Units list opened.



No barometric module.

### Bar Graph

An optional bar graph can be displayed below the current pressure value. The bar graph indicates the position of the current value with the maximum range of the primary measurement module in that channel. This bar graph will appear in the Home view when selected from the **Display Settings** presented on page 35.

## Auxiliary Displays

The screen in the uppermost picture below shows all of the possible auxiliary display items that can be included in the Home view. The Home view can have up to three auxiliary displays which can be chosen by clicking on each button and then selecting the display item from the menu on the right side of the screen (the lowermost picture below).

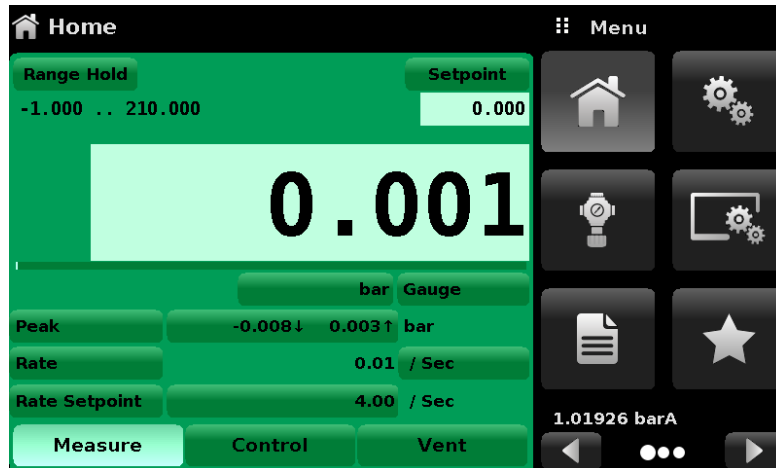

*Home view with auxiliary displays.*

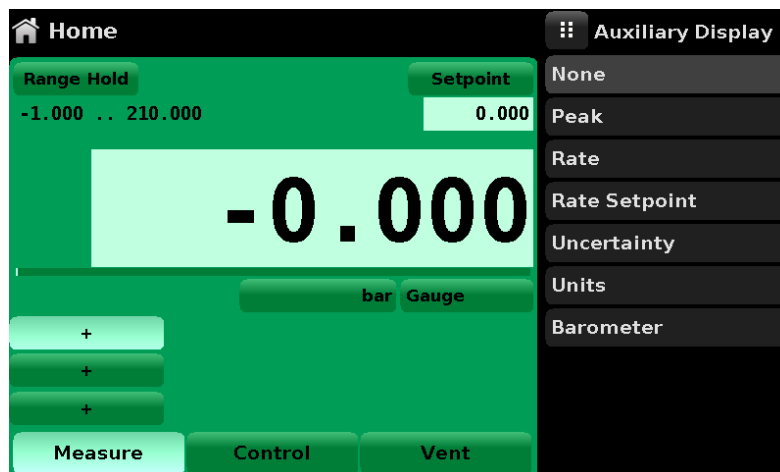

*Auxiliary display selection.*

Each auxiliary display can be modified by pressing the displayed button.

**Peak:** Pressing the Peak button will reset the upper and lower peak value to the current reading, subsequent negative or positive divergence from that reading will be recorded in the button.

**Rate:** Pressing the Rate button will display a choice of time rate units for the rate denominator.

**Rate Setpoint:** Pressing the Rate Setpoint button will let the user enter the new Rate Setpoint via multiple entry methods.

**Units:** Pressing the Auxiliary Units button will display the same set of units available for the primary units. Pressing any of these units will change the auxiliary units to that chosen unit.

## Zero Button

If the Zero Calibration function has been chosen in the **Display Settings** presented on page 35, then the Zero Cal Button [  ] will appear in the Home view. If the instrument is measuring absolute pressure, and the Zero Cal Button is pressed, a keyboard will appear to allow a single point calibration. If the instrument is measuring gauge pressure, pressing the button will set the current reading to zero. If the instrument is in emulation mode (absolute or gauge) then the value will not be saved to the sensor but only as a temporary adjustment while in emulation mode. After exiting the emulation mode or after a power cycle, the temporary adjustment will be cleared. The zero adjustment not in emulation mode will be saved to the sensor as if single point calibration had been performed.

The pictures below show the instrument with zero cal function enabled. The picture on the left shows instrument in gauge mode. The picture on the right shows the same instrument, but the zero button on the absolute mode has been pressed, showing the keypad enabled to accept a new single point calibration value.

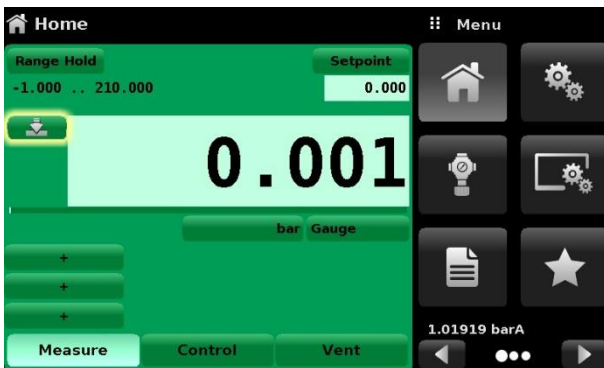

*Gauge pressure, zeroing.*



*Absolute pressure, zeroing.*

The background color of the zero button will momentarily change to a lighter color as the zero calibration is performed then will revert back to a darker color when complete.

## Tare Button

If the Tare calibration function has been chosen in the **Display Settings** presented on page 35, then the Tare Button [  ] will appear in the channel screen. The Tare button and the Zero Button cannot appear on the screen at the same time, in the same channel. When the Tare button is pressed, the instrument will subtract the current pressure reading (the tare pressure) so that the indicator will display zero. Subsequent deviations in pressure will be relative to the tare pressure.



*Tare button.*

Pressing the tare button again will deactivate the tare and change the pressure indication back to the reading corresponding to the calibrated output of the measurement module. An active tare will revert to a deactivated state after a power cycle.



## Operating Mode Selection

The operating modes are permanently displayed on bottom of the Home view. There are three operating modes: Measure, Control and Vent. After the system has switched on, the instrument will automatically be placed in Vent mode. The user can switch from one mode to the other by using the mode selection keys.





**Notice**

**When switching from Control mode to Measure mode, the system will not be vented and the last applied pressure will be locked in the system by means of a solenoid valve.**

**Measure Mode:** In Measure mode the device acts like a precision pressure measuring instrument and measures the pressure applied at the Measure/Control port. If the Control mode was the last used mode before switching into Measure mode, the last controlled pressure is held in the test assembly.

**Control Mode:** In Control mode the device provides a controlled pressure at the Measure/Control port equal to the setpoint value. It is activated by pressing the Control button. In order to ensure smooth operation in the control mode, following measures must be taken and respective parameters must be set.

- In order to control pressures close to or below atmospheric pressure, a vacuum pump should be connected to the Exhaust port.
- The control speed can be set in the Control Settings view [  ]. The Control rate can be set between 0.001% of range/sec to 20% of range/sec.
- Control limits can be set in the Control Settings view [  ].

**Vent Mode:** The Vent function will vent the system to the atmosphere, including the test assembly connected to the Measure/ Control port. The Vent mode can be activated from the Measure or Control mode by pressing the Vent button. The vent rate can be set in the Control Settings view [  ]. The vent rate can be set between 0.001% of range/sec to 20% of range/sec.



**Warning**

**Venting will cause a loss of pressure at the vent rate in the system and the plumbing connected to the measure control port. Care must be taken that the device under test is not damaged during venting.**

## Settings View

The Settings view [  ] is used to set up general settings for the display. Settings parameters include Language, Brightness, Volume, User 1 base units, User 1 multiplier, User 2 base units, User 2 multiplier, Barometer units, and Configuration. The picture below shows these parameters as indicated when the Settings view has been chosen. As each parameter is pressed, an input screen will appear on the right where selections can be made.

The Settings view provides a place to change the language, display brightness, volume, user units, and barometer units. Configuration settings of the unit can also be saved in this view plus the default configuration can be activated.

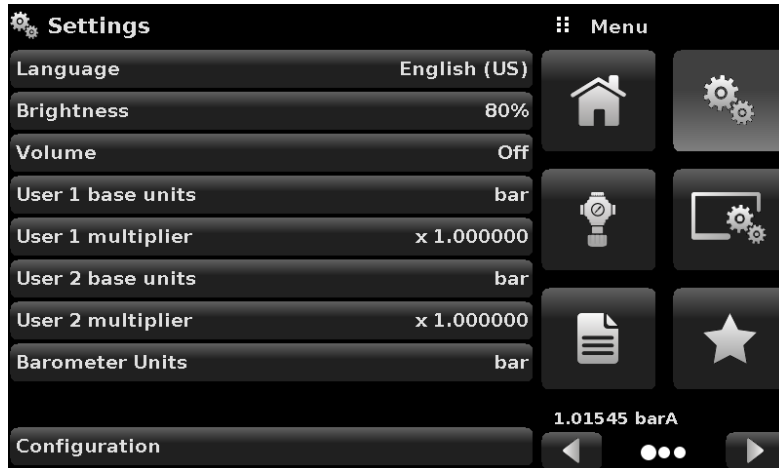

*Settings view.*

## Language

The Language setting provides a selection of different languages. Once a language is chosen all words within all menus will appear in the chosen language and the radix character (decimal mark) will change from a dot (.) to a comma (,) depending on the language chosen. More languages can be accessed by navigating to the next page of the language selection menu on the right side of the screen.

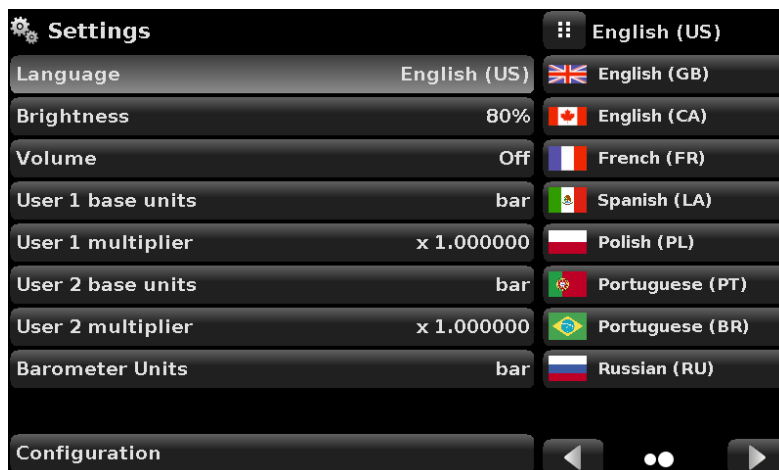

*Languages.*

## Brightness

The Brightness setting provides a sliding scale to increment the screen brightness in all screens. Sliding your finger along the bar graph or touching anywhere in the bar graph will change the brightness of the screen. After the setting is made and your finger is removed from the screen the menu will show the brightness percent selected.

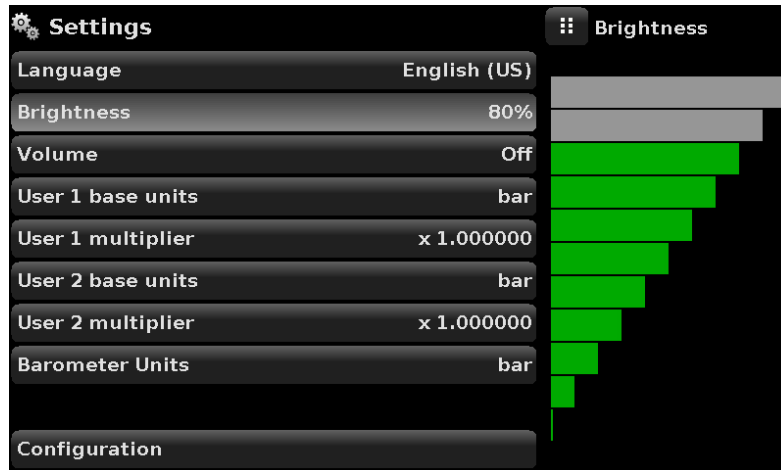

*Brightness.*

## Volume

The Volume setting provides a way to turn on or off the touch screen audio feedback.

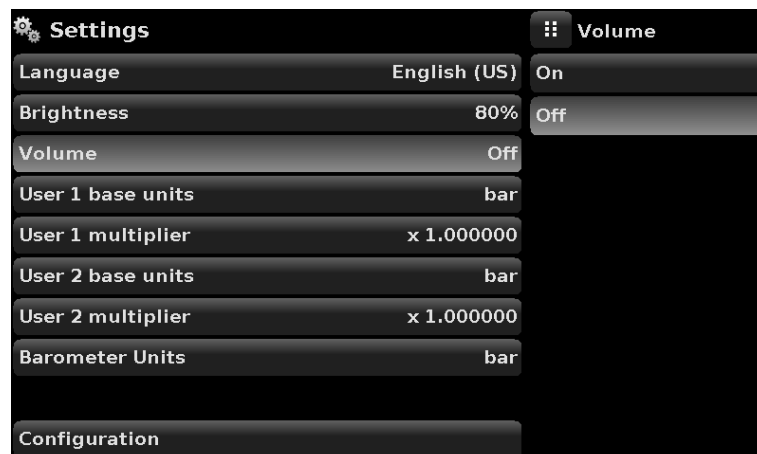

*Volume.*

### User base units / Base units multiplier

When choosing a unit of measure from the Home view (main screen), standard units can be chosen in addition to two user defined units. User units 1 and 2 are defined in the Settings View using “User 1 base units”, “User 1 multiplier” and / or “User 2 base units”, “User 2 multiplier”. For example, if the display of one atmosphere (atm) was needed, then psi could be chosen as the “User 1 base unit” and the “User 1 multiplier”, in this case, would be 0.068045. When set this way and the user 1 unit has been chosen, the user 1 unit will now display the pressure in atm.

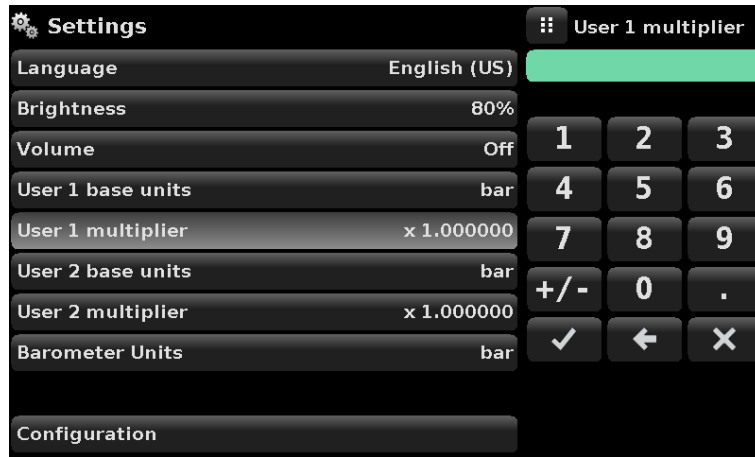

*User base units / Base units multiplier.*

### Barometer Units

When the Barometer Units Parameter has been chosen, a list of Imperial or Metric units is presented on the right side of the screen. Any of these units can be chosen from this list for the barometric readout that can be seen on the bottom right of the Home view.

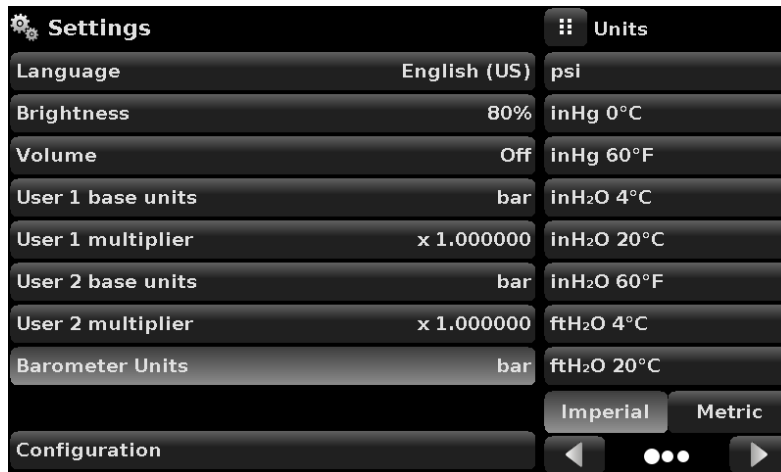

*Barometer units.*

## Configuration

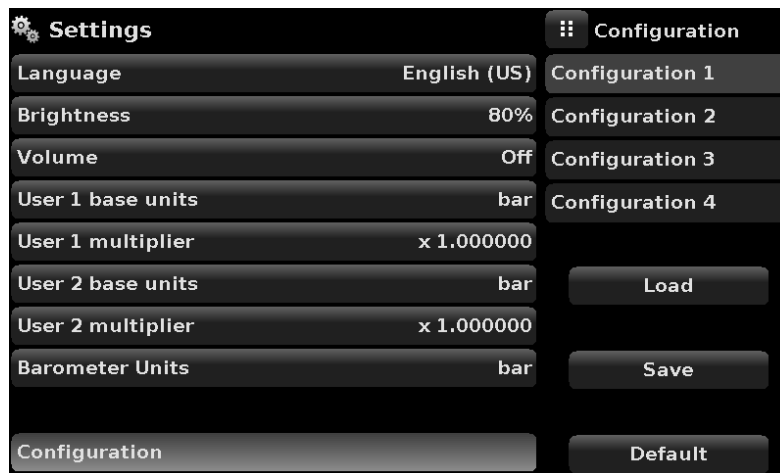

Configuration is the last parameter in the Settings view. It allows the operator to save instrument settings and load them, as needed, in the future. Parameters that are set in the Settings view, the Frames view, the Transducer view, and the Remote view can be saved using the Configuration “Save” button and recalled using the Configuration “Load” button. Simply set all desired parameters then go to Settings-Configuration, press one of the numbered Configuration buttons then press the “Save” button. This will save the current configuration in that button. To reload a saved configuration at a later time, go to Settings-Configuration and press the numbered configuration button corresponding to the saved configuration and then press the “Load” button.



*Configuration.*

The instrument default configuration can be activated simply by pressing the “Default” Button.

## Control Settings

The Control Settings view [  ] allows the user to select and configure the control parameters for the solenoid valve controller in the instrument. This display remains the same for either one or two pressure modules. The Control Settings screen is divided into two pages and can be navigated using the Next Page [  ] and Previous Page [  ] buttons. The Control Settings view provides two preset control modes “Precision” and “High Speed” which affect the “Control Behavior”, “Rate Setpoint”, “Stable Limits” and “Stable Delay”. The Precision control mode is set as default and provides a stable control rate at medium overshoots. The High Speed control mode provides faster control rate at a higher overshoot. Each of the control parameters can be changed by the user to best suit their application in the “Custom” control mode. The “Custom” control mode retains the values of the parameters entered by the user until the user changes it again. The first two pictures below show the Control Settings view in “High-Speed” control modes. The lowermost picture shows the first page of the Control Settings view in “High-Speed” control modes.

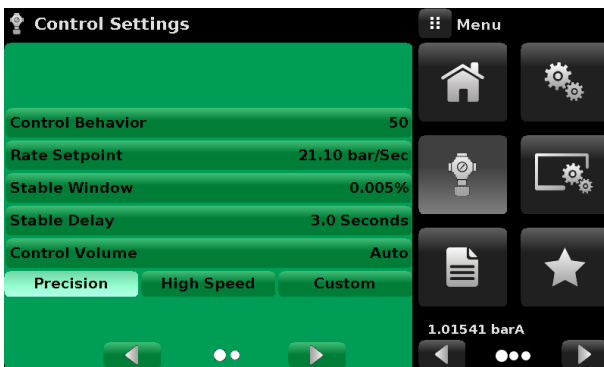

*Control Settings.*

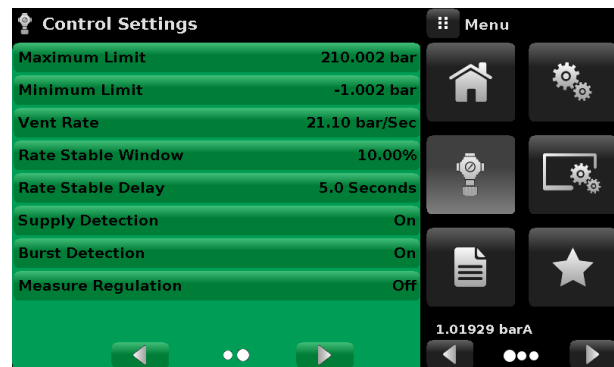

*Control Settings.*

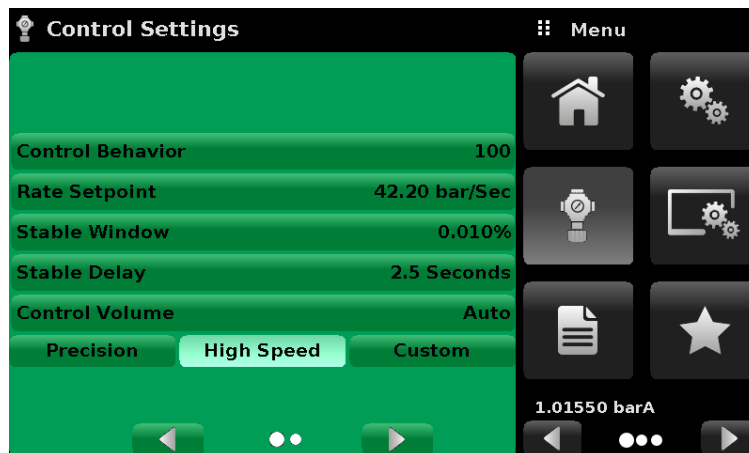

*High Speed control mode.*

## Control Behavior

The Control Behavior button in the Control Settings view provides a choice between different levels of control behavior ranging from “0” to “100” where “0” represents lowest overshoot control mode and “100” represents High Speed control mode. The Control Behavior is preset to “50” for Precision control mode and to “100” for High Speed control mode. The Control Behavior can be changed using the sliding scale. This will change the control mode to “Custom”. The picture level shows the sliding bar to adjust control behavior.

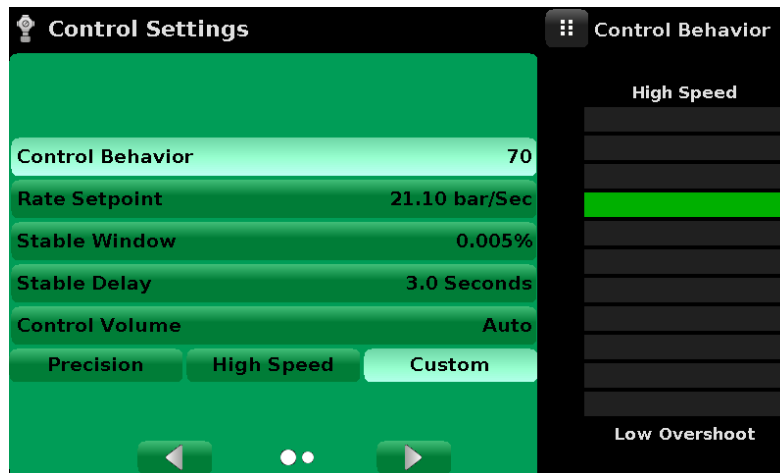

*Control Limit Setting.*

## Rate Setpoint

The Rate Setpoint button allows the user to set the rate of pressure change when the device is controlling up or down to a setpoint (picture below). The rate is limited to 0.001% of span of active range of the measurement module/second to 20% of the full scale range/second.

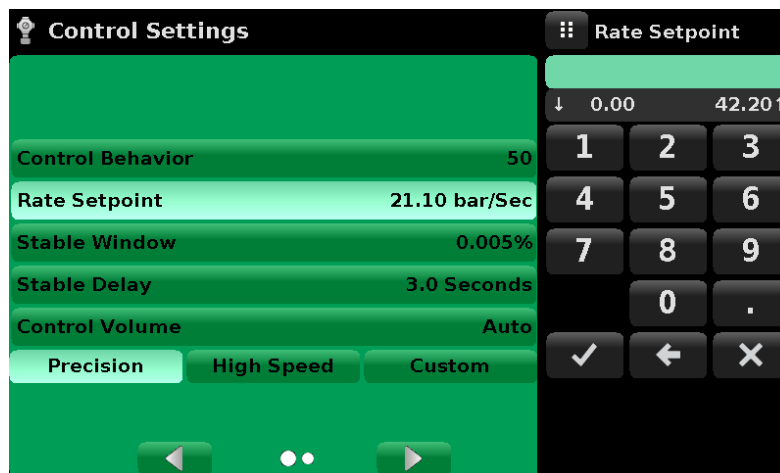

*Rate Setpoint.*

## Stability Parameters

Stability parameters for the controlled pressure can be found in the Control Settings view and can be configured using the Stable Window and Stable Delay buttons. When the controller enters a stable condition the pressure indication color on the Home view will change from white to green. The Stable Window button allows the user to enter a value as a percentage of the highest range pressure module. This value represents the pressure window within which any setpoint value would be considered stable by the user. The Stable Delay button lets the user add a desired delay until the pressure value is considered stable while being in the stable window.

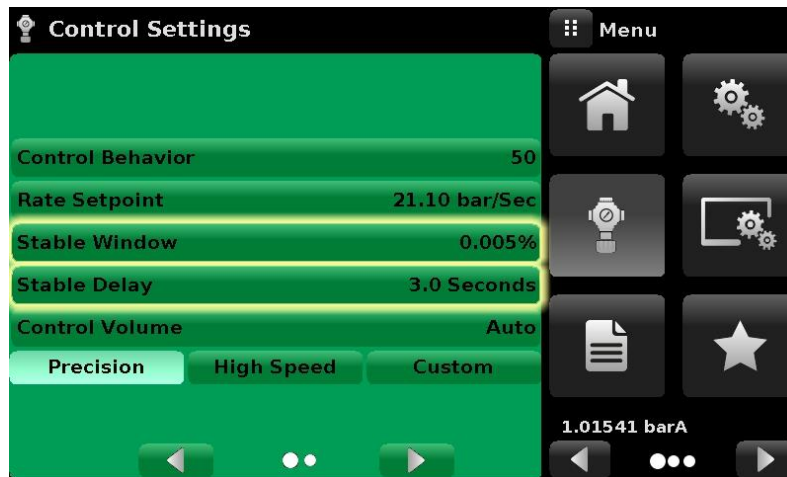

*Stability parameters highlighted.*

## Control Volume

The Control Volume button in the Control Settings view allows the user to control pressure volume in "cc". The device is capable of automatically identifying the control pressure volume and adjusting the control parameters based on it. By default this button is set on "Auto". The picture below displays the control volume setting for the instrument.

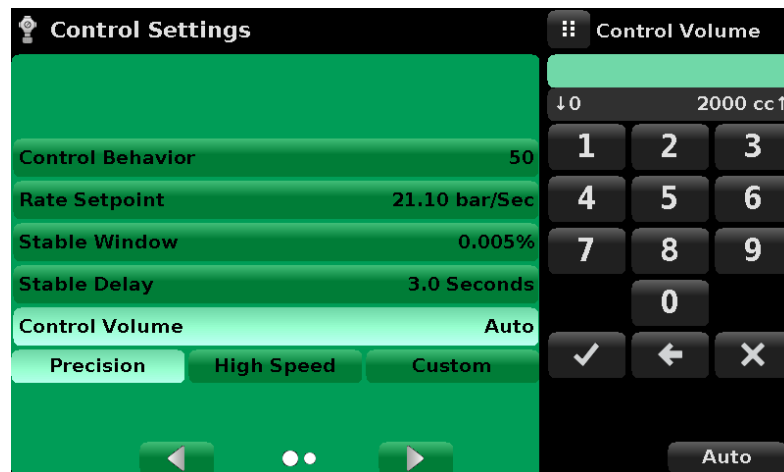

*Control Volume.*



## Control Limits

The Maximum and Minimum Limit buttons can be accessed by clicking the Next Page [  ] button in the Control Settings view. These buttons provide a place to limit the setpoint value that can be chosen in the Home view. These limits can only be set within the range of the active pressure module. When the instrument is in Autorange the limits can only be set within the range of the primary pressure module which, by convention, will have the widest range. The minimum limit must be lower than the maximum limit. The user can not enter setpoints and thereby not control to pressures outside of these limits.

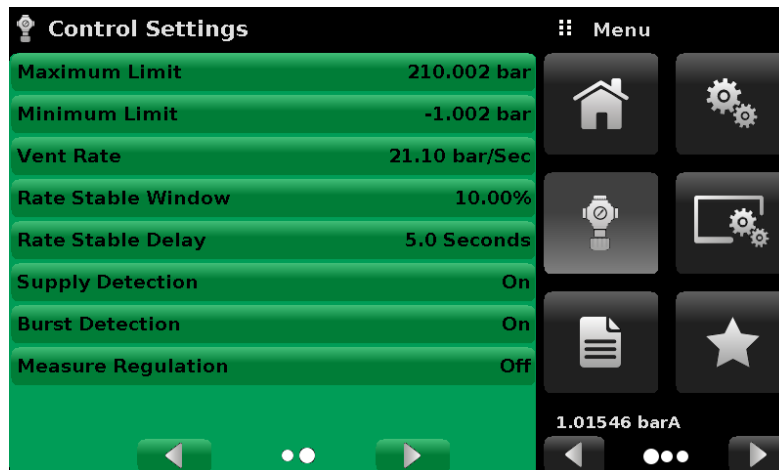

Control limits.

## Vent Rate

The Vent Rate button in the Control Settings view lets the user to determine the rate at which pressure will vent in vent mode. By default the rate of the vent is set similar to the control rate. The rate is limited to a maximum of 20% of the full scale range/ second. The picture below displays the vent rate setting for the instrument.

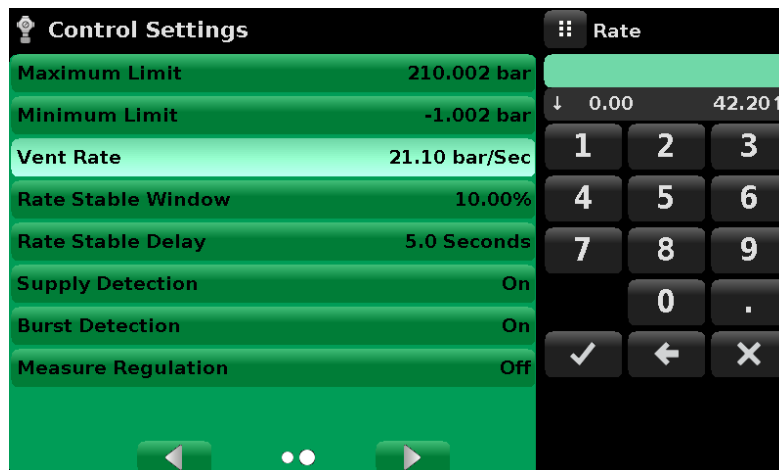

Vent rate.

## Rate Parameters

Rate parameters for the control rate can be found in the Control Settings view and can be configured using the Rate Stable Window and Rate Stable Delay buttons. The Rate Stable Window button allows the user to enter a value as a percentage of the active range of pressure module. This value represents the pressure window within which the control rate value would be considered stable by the user. The Rate Stable Delay button lets the user add a desired delay until the control rate is considered stable while being in the rate stable window.

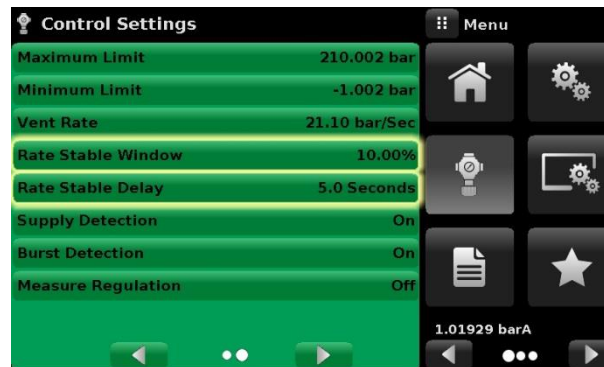

*Rate parameters highlighted.*

## Detection Flags

POC8 is equipped with three detection flags that can be enabled or disabled by the user as needed. These detection flags appear in the Control Settings view. The primary purpose of these detection flags is to protect the device and to ensure desired operation. Each of these flags can be turned “On” or “Off” as per user’s need. The picture below shows the detection flag settings.

**Supply Detection:** If turned “On”, this flag allows the user to check for sufficient supply pressure at the Supply Port of the instrument. In case the supply pressure is less than over 10% of the control setpoint, an error is reported which can be seen in the Troubleshoot view by clicking the error symbol [  ].

**Burst Detection:** If turned “On”, this flag allows the user to protect the instrument against sudden bursts in the pressure at the Measure/ Control Port. In case a burst is detected, an error is reported which can be seen in the Troubleshoot view. This flag is turned “Off” by default.

**Measure Regulation:** If turned “On”, this flag allows pressure to be controlled while the instrument is in “Measure” mode to prevent pressure leaks in the system over time. This will turn on the internal pressure controller periodically to control pressure in a certain range of the measured pressure value. This flag is turned “Off” by default.



*Detection Flags highlighted.*

## Display Settings

The Display Settings view [  ] allows the user to configure display properties like the filter for the reading to reduce fluctuations due to electrical noise, and to set the resolution of the reading. In addition, the bar graph display and calibration function can be specified here.

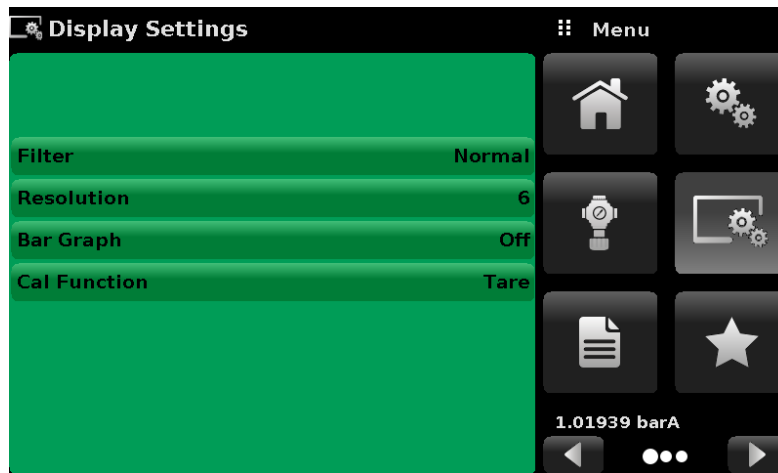

*Display Settings.*

## Reading Filter

The Filter is an electronic filter to smooth out the pressure readings. Because of differences in resolution, greater filtering may display a more stable reading for some pressure units. Turn off the Filter by selecting "Off", select varying degrees of filtering for the current units by selecting "Low", "Normal" or "High".

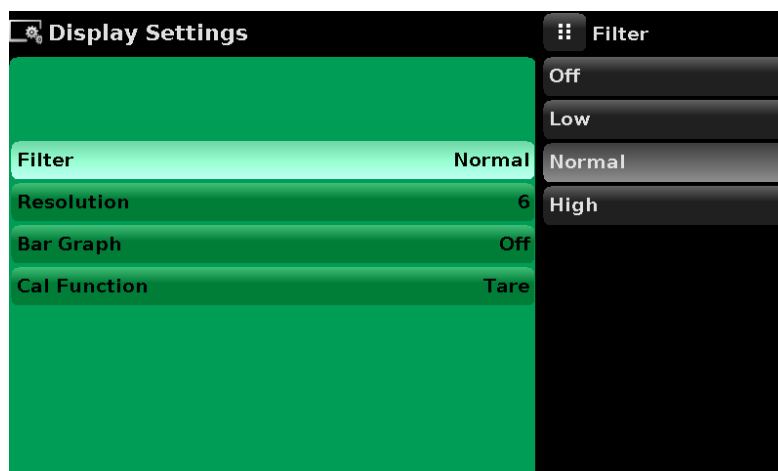

*Reading Filter.*

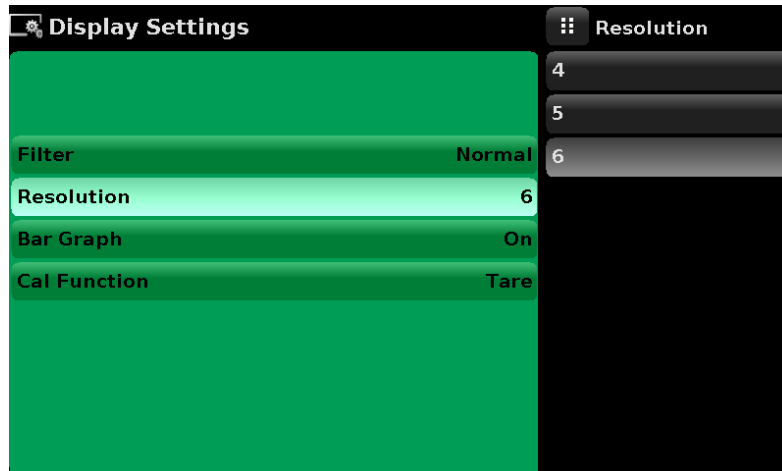

## Reading resolution

The Resolution of the displayed pressure value for each Channel can be set in the Display Settings view using the resolution Parameter. The resolution can be set to 4, 5 or 6 digits.



*Reading Resolution.*

## Cal Functions

The Cal Function presents a choice of None, Tare or Zero. Choosing Zero will enable the Zero Cal Button [  ] in the Home view. Choosing Tare will enable the Tare Button [  ] in the Home view. The Tare button and the Zero Button cannot appear on the screen at the same time. See chapters **Zero Button** on page 24 and **Tare Button** on page 24 for operation of the Zero and Tare buttons in the Home view (main screen).

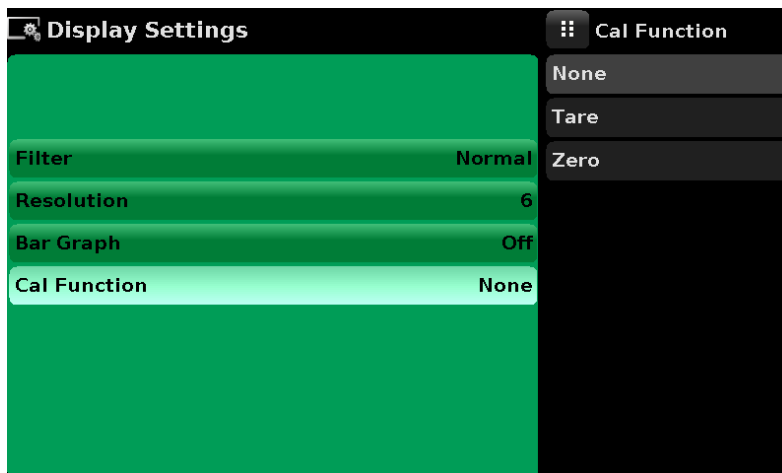

*Cal Function.*

## Programs

The Programs view [  ] is used to create, view and edit programs that are used to automatically run a sequence of commands within the device. The Programs view screen displays the contents of the first written program in read only mode by default (leftmost picture below). User can load, edit and delete other saved programs by clicking on the title of the current program and then selecting the desired program sequence from the sidebar (rightmost picture below).

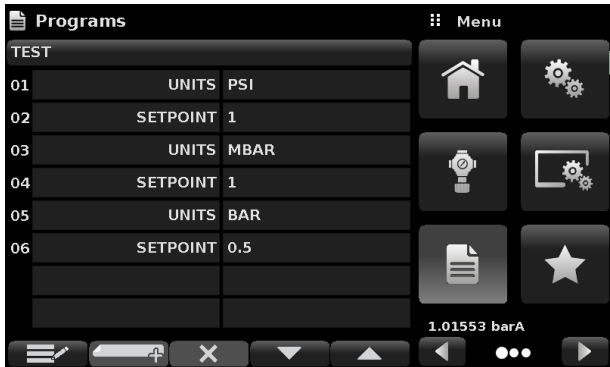



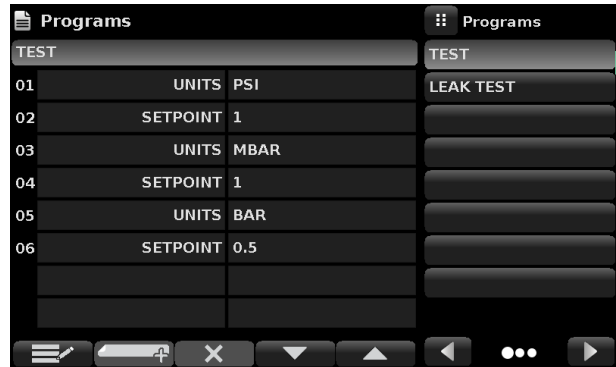



Programs view.



Load, edit or delete programs.

## Edit Programs

By default the programs are available in read only mode to prevent accidental changes to existing programs. The users can edit existing programs or create steps in new ones by clicking on Edit Program [  ] button (leftmost picture below). This makes the program editable and also activates the Insert [  ] and Delete [  ] buttons which are otherwise just labels and can't be clicked by the user. A series of predefined commands can be chosen to write the steps of a program. Selection of commands and data in each sequential line will create a draft of resulting command sequence in the selected program (rightmost picture below). Upon exiting the edit mode by pressing the Edit Program [  ] button, the system will ask "Save changed programs?" Pressing the [  ] button will accept the changes, pressing the [  ] will revert back to the old program. A list of available commands, data values and their functions are listed in the table on next page.



Editable programs view.



New line creation.

**Table – Sequence Commands**

Command	Function (data selection)
UNIT	Sets the pressure unit for operation
DELAY	Delays for time = 1 to 3600 seconds (Numerical Entry)
MODE	Sets the control mode (Measure, Control or Vent)
PTYPE	Sets the pressure type (Gauge or Absolute)
RSETPT	Sets the rate setpoint in current units (Numerical Entry)
RUNITS	Sets the rate denominator time unit (min or sec)
SENSOR	Sets the active measurement module (1, 2 or 3)
SEQSTART	Starts the sequence from the beginning (None)
SETPOINT	Sets the control setpoint for the instrument (Numerical Entry)
SETPOINT%	Sets the control setpoint in % of current range (Numerical Entry)
WAIT	Waits for a manual input or stable condition (Stable or Input)

## Favorites View

The Favorites view is used to select programs that will appear in the Home view when the Favorites [★] is pressed. The purpose of the Favorites view is to provide quick access to frequently used programs. The current list of favorites is shown in leftmost picture below. The desired program can be selected by clicking on its name which takes the user to the Programs view where the program can be run by clicking on the Play [▶] button. A maximum of eight programs can be stored as favorites.

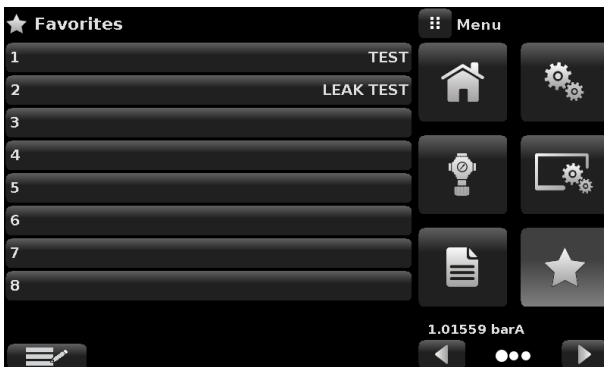

*Favorites view.*

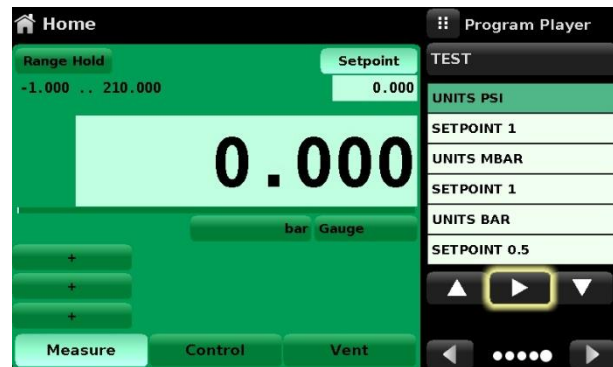

*Play button highlighted.*

## Information View

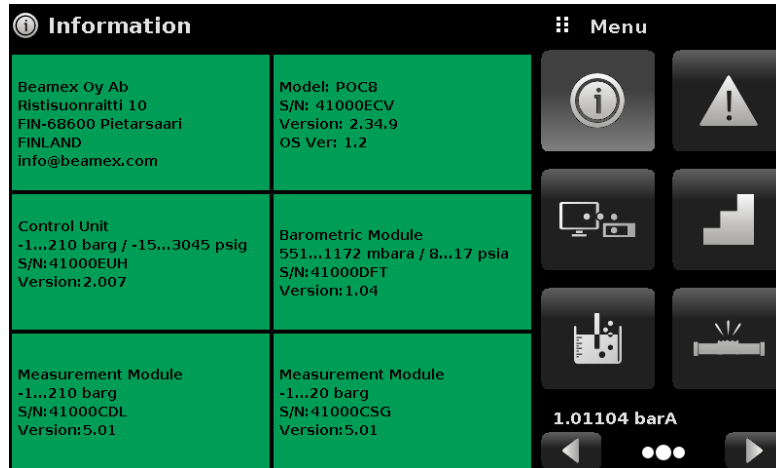

The Information view [  ] displays information about the device, including:

- Beamex address, and email
- Model number, serial number and operating software version.
- Control unit, serial number and software version.
- Pressure measurement module(s), range, serial number, and software version.



*Information view.*

## Troubleshooting View

The Troubleshoot view [  ] can be found by navigating to the second page of buttons on the left. It is done by clicking on the Next Page [  ] button. The Troubleshoot view will display information about error conditions and remote communications. Within the troubleshoot screen (leftmost picture below), push the Error button to display any errors that have occurred in the instrument due to a communication or network error. Push the Remote Settings button (rightmost picture below) to show commands and responses that have been sent over the remote communication connection. If there are any errors in the error queue an error symbol [  ] will appear in all screens (lowermost picture below). Pressing this error button from any screen will open the Troubleshoot view where the error can be viewed.



*Troubleshoot error view.*



*Troubleshoot remote view.*



*Error indication.*



## Remote Settings View

With the Remote Settings view [  ] user can select the remote command set for all interfaces. The GPIB address (IEEE-488), and Serial parameters (Serial RS-232 or USB) can be set on the first page and Ethernet network parameters on the second. Details about the Remote Operation (command sets, cable requirements, etc.) can be found in chapter **Remote Operation** on page 49.

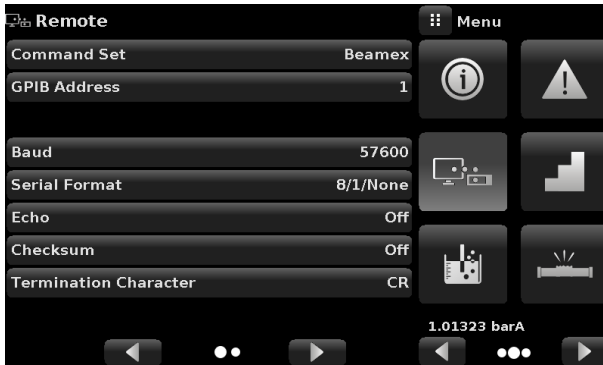

*Remote Settings view, page 1.*

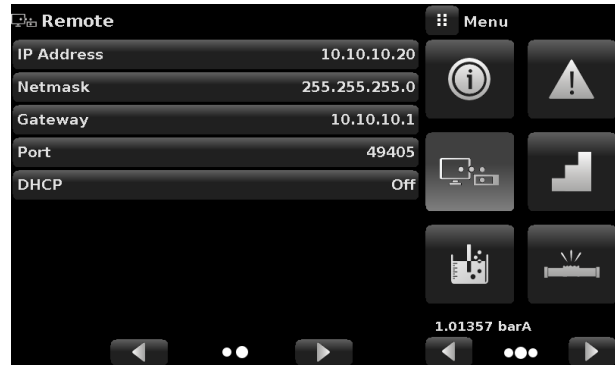

*Remote Settings view, page 2.*

## Remote Command Set

The remote command set parameter provides a choice of the Beamex, SCPI or DPI5xx command set. The Beamex commands are listed in chapter **Remote Operation** on page 49.

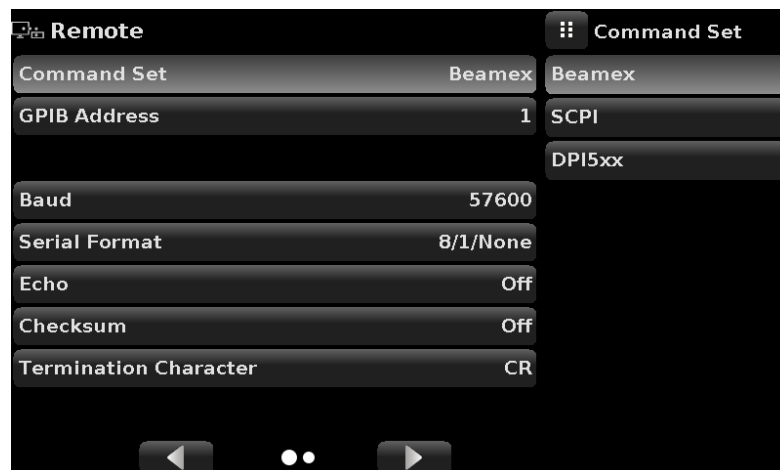

*Remote Command Sets.*

## Remote Communication Settings

The remainder of the Parameters in the Remote view present the choice of a numeric entry, a numeric address entry, or a radio button selection. The parameters that require a numeric entry will present a numeric keypad with min and max limits for the variable. The parameters that require a numeric address (for example an IP address) will also present a keypad. Address entries should conform to the format of the parameter selected. The three screens below show examples of each type.

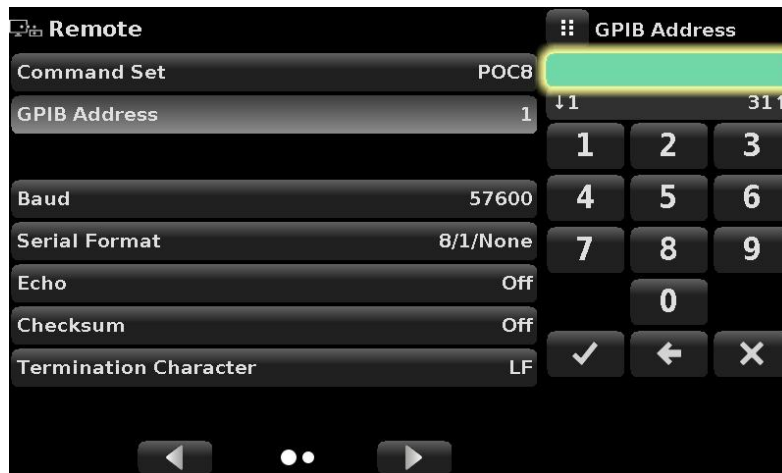

*GPIB Address, numeric entry field highlighted.*

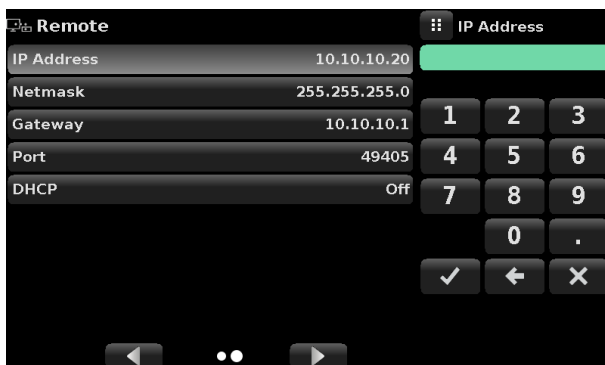

*IP Address.*

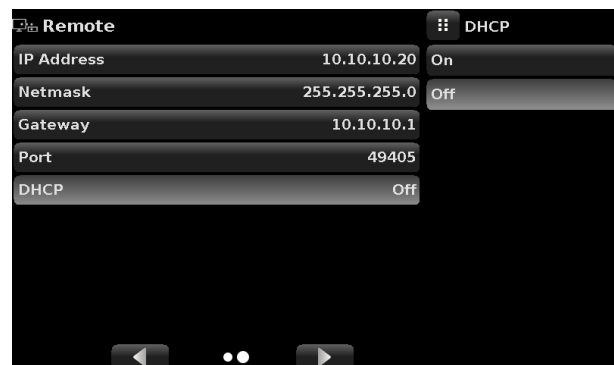

*DHCP Setting.*



Setting the Ethernet DHCP to yes will have a short delay while the DHCP server is contacted. If a DHCP server is not found, an error will be indicated. If DHCP is enabled, the IP address, Netmask and Gateway are greyed out and locked, these are controlled by the DHCP server.

A successful communication link between the instrument and the various interfaces is indicated by a Remote Settings Icon [  ] at the top of the screen.

## Step Settings View

The Step Settings view [  ] allows the user to enter control setpoint value or write program sequences as a factor of the percentage of the device under test operating pressure range or as fixed pressure values (uppermost picture below). The user can enter the minimum and maximum range of the device under test (two middlemost pictures) and then select the desired percentage value(s) or desired fixed pressure value(s) for setpoint(s). These ranges should be within the maximum range of the primary pressure measurement module. The user can also enter the control point up to a maximum of 5% over the range of the device under test limits by entering the overrange percentage (lowermost picture below). POC8 automatically calculates the pressure value of the setpoint based on this selection. The user can be directed to this view from the setpoint entry menu in chapter **Home View** on page 18.

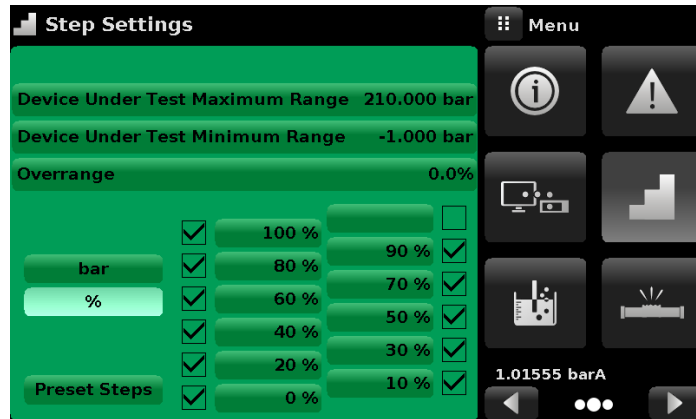

Step settings view.

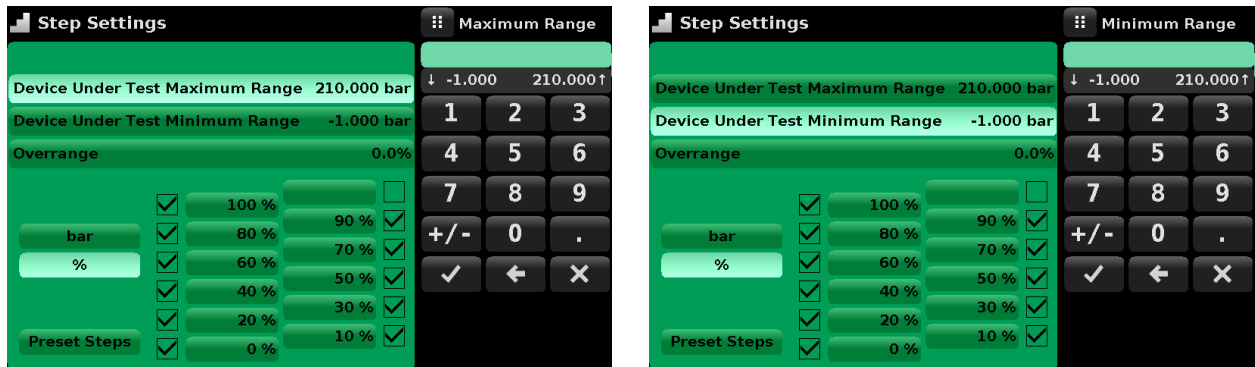

Range selection, minimum and maximum.

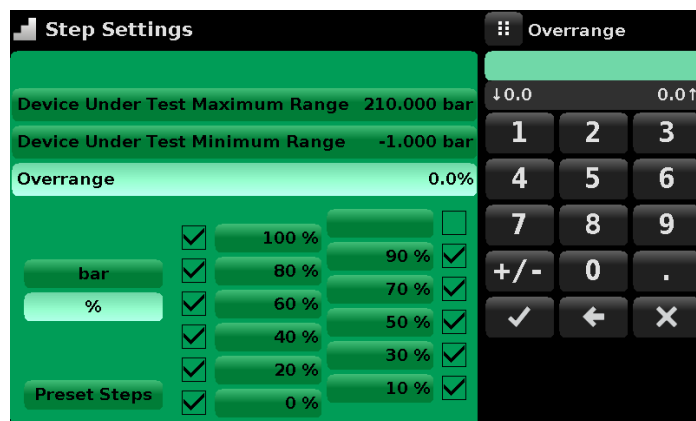

Overrange Selection.

### Preset Steps

The user can have up to 12 different points along the range of the device under test (DUT). The Preset Steps button allows the user to enter the number of points and then automatically divides the range in equivalent percentages. For example if the user needs 6 distinct points along the DUT range then enter 6 in the numeric keypad and press Enter [  ] button. POC8 will create setpoints at 0%, 20%, 40%, 60%, 80% and 100% of the DUT range. The user also has the option of changing these percentage values by clicking on the individual Percentage button on the Step Settings view. The user can enter any percentage between 0 and 100. The desired value can then be chosen by checking the box [  ] beside the Percentage button.

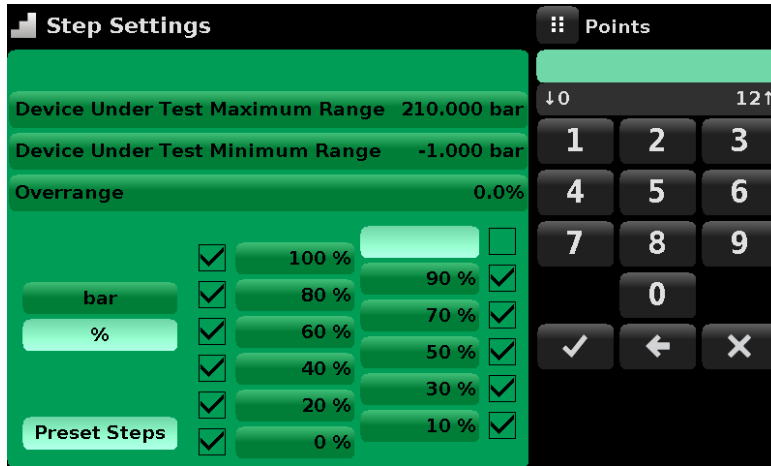

Preset Steps Entry.

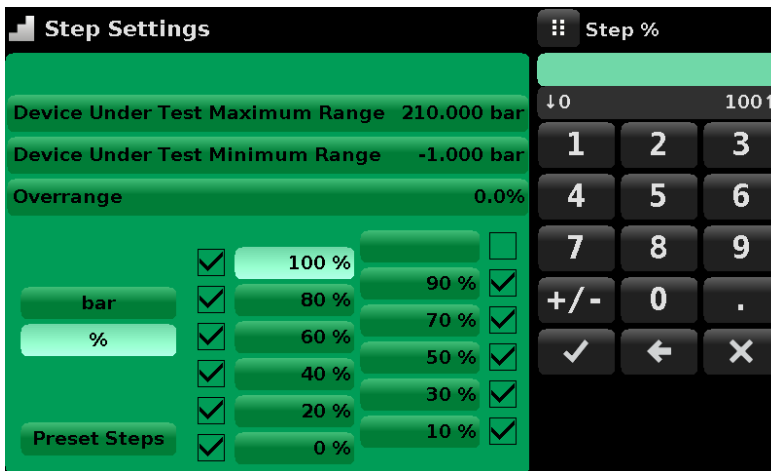

Percentage Value Entry.

## Leak Test

Leak Test [  ] is a device under test specific feature (uppermost picture below). The user selects the pressure module first or sets the device to “Autorange” and then defines a leak by setting the Setpoint, the time parameters and the Delta parameter (two lowermost pictures). With the system pressurized to a predetermined amount, the leak test is initiated by pressing the Start button. The device drives the pressure to the entered Setpoint and then switches to “Measure” mode. At this time the leak test is initiated. If the change in pressure exceeds the Delta parameter before the allotted time in the Time parameter, then the Leak Test will return a red status indication showing the actual difference (delta) in pressure recorded during time period set in the leak test, indicating a “failed” test. Otherwise it will return a green status indication showing that the delta was not exceeded for the time period, indicating a “passed” test.



Leak Test.



Setpoint entry.

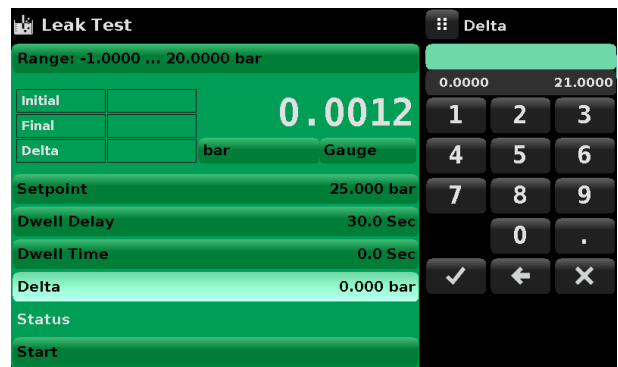

Delta entry.

## Burst Test

Burst Test [  ] is a device under test specific feature (uppermost picture below). The user selects the measurement module first or sets the device to “Aurorange” and then programs a pressure burst by entering the low point and high point of pressure. For the device under test to pass the burst test, it must burst at a pressure greater than Low Point and less than the High Point. The user then enters a fast rate which is the control rate to reach the low pressure point and then enters the slow rate which is the control rate between the low and high pressure point. The burst test is initiated by pressing the Start button. The status of the test is shown next to the pressure reading (lowermost picture).

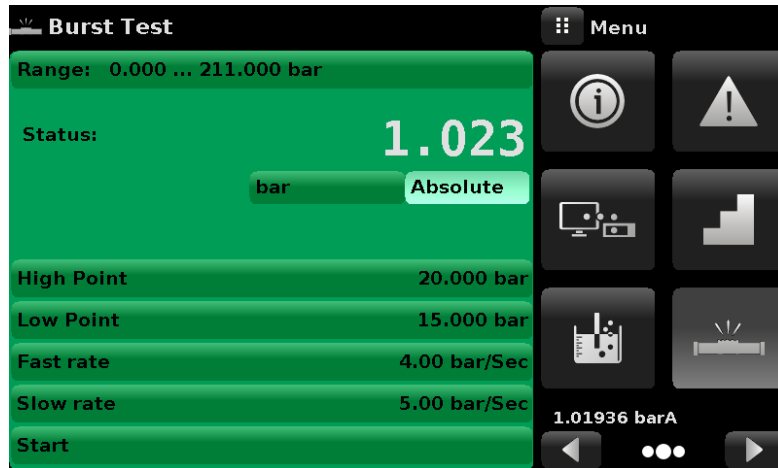

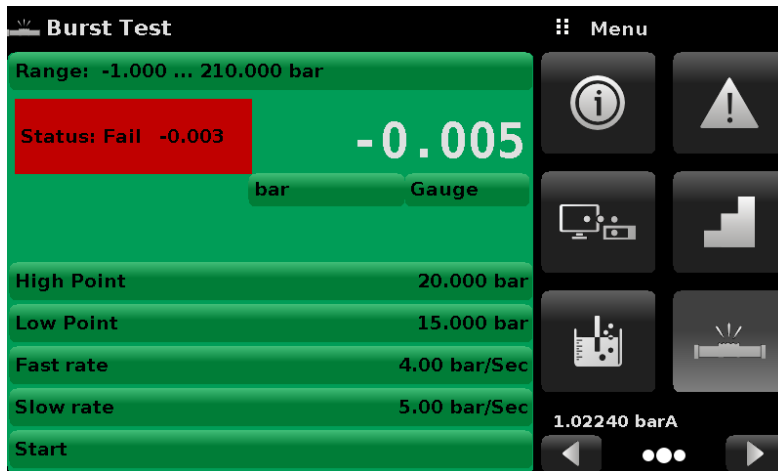

*Burst test screen.*



*Burst test - status.*

## Service View

The Service View [  ] can be found by navigating to the third page by clicking the Next Page [  ] button at the bottom right corner of the button section of the screen. It is a password protected area where calibration of all connected modules can be accomplished. In addition, this is where the password for entering this area can be changed.



*Service view (locked).*

Press the Enter button to show the numeric keypad to enter a password. This will unlock other functions. Default password is 123456. Enter 123456 and press the check mark [  ] to unlock the Service view.

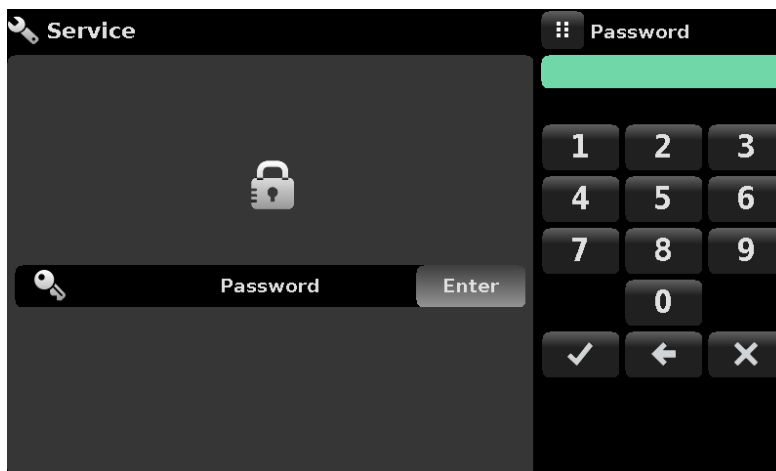

*Service view. Entering a password.*



### Notice

The default Password is 123456. After entering this for the first time, the password can be changed.

## Unlocked Service View

After the Password has been entered, the unlocked Service view will appear (see picture below). To re-lock this screen, press the lock button.

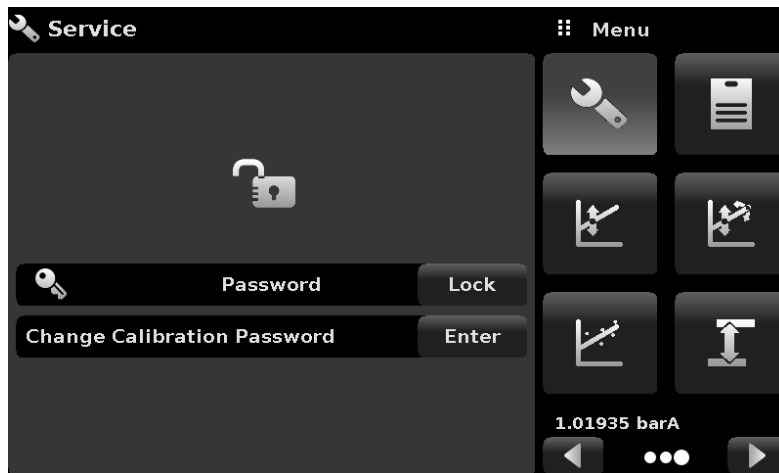

*Unlocked Service.*

From the Unlocked Service view, the Password can be changed by pressing the Enter button next to the Change Password label. This will open a keypad where a new password can be entered and accepted by pressing the Check Mark [  ].



**Notice**

**Please make note of a password change and save the new password in a secure location.**

The Unlocked Service view is the access point to all calibration screens described in Section 10 of this manual.



**Notice**

**Note: Recommended calibration setup and explanation of calibration screen is covered in chapter Calibration on page 75 of this manual.**



# Remote Operation

Use the screens in Section Remote view to set the operating parameters for the instrument command set, Ethernet, Serial (RS-232) and IEEE-488 (GPIB) information.

---

## Command Set

Command Set button – Users can select which model remote protocol they would like to emulate for simulation and testing purposes. Selections may include the following:

- Beamex (default)
- SCPI
- DPI5xx

## Operation with Beamex calibrators

Connect the POC8 to the calibrator as shown below:



---

## IEEE-488

IEEE-488 address button – Allows the user to set the GPIB address by inputting a numeric value utilizing the touch screen.

### IEEE-488.2 Commands

Command or Query	Response / Function
*IDN?	Returns identification string
*RST	Reset to known state (default+psi)
*TST?	Returns 1
*OPC	Operation completed
*WAI	Returns operation completed state
*CLS	Clear status and error queue
*ESE	Enable status event
*ESE?	Returns enable status even value
*ESR	Event status register
*ESR?	Returns even status register value
*SRE	Service request enable
*SRE?	Returns service request enable value
*STB?	Returns status byte

---

## Ethernet

The Ethernet function allows the user to set the following by inputting a numeric value in each separate field:

- IP
- Netmask
- Gateway
- Port
- DHCP settings

Set the Ethernet communication parameters as described in chapter **Remote Operation** on page 49.



**Caution**

**Please contact your network administrator for proper settings.**



**Caution**

**Please consult your computer resources department prior to connecting this instrument to your network to verify there are no conflicts with existing IP addresses.**

The Ethernet communication port allows the POC8 to communicate with computers using 10/100Based-T specifications.

Before using Ethernet communication, four parameters must be set up: IP, Netmask, Gateway, and Port.

---

## USB device (Virtual Serial Port)

The USB virtual serial communication port allows the POC8 to communicate with USB hosts, while retaining the semantics of legacy serial ports for application level. Settings are fixed as:

**57600 baud, 8 data bits, 1 stop bit, no parity.**

Most modern operating systems have drivers for the used USB serial port converter.

## Serial

Set the Serial communication parameters as shown in chapter **Remote Operation** on page 49. The serial communication port allows the POC8 to communicate in RS-232 format with computers, terminals, PDAs, or similar hosts.

These parameters should be set to match your host computer. Default settings are: 9600 baud, 8 data bits, 1 stop bit, no parity, and no echo.

If echo is ON, the POC8 will immediately echo back characters sent over the serial port. The Serial function allows the user to set the RS-232 serial port settings by selecting from the choices provided:

Baud:

- 9600
- 19200
- 38400
- 57600
- 115200

Data Bits:

- 7
- 8

Stop Bits:

- 1
- 2

Parity:

- Even
- Odd
- None

Echo settings:

- On
- Off

## Serial Cable Requirements

RS-232 communications are transmitted over a three conductor, shielded cable terminated in a standard DB9 connector on the instrument end, and a different gender connector on the host end. The proper pin-outs are shown in the following illustration.



---

## Command and Query Format

Commands must be sent in ASCII format and terminated with either a carriage return (<cr>), linefeed (<lf>), or both. Commands are not case sensitive. Each query returns a response. If an error is detected the response will include an error flag.

**Command or Query field:** Unless otherwise specified, commands are typically converted to queries by appending a question mark to the command. A table in chapter **Beamex default command set** on page 55 lists all of the POC8 command or query keywords.

**Data field:** The data field is either in ASCII {string} or numeric {value} form. In the case of multiple data fields, commas are required to separate the fields. Queries do not have a data field. String (text) or value (numeric) data are acceptable in any of the following formats:

Examples of {string} data: ON, OFF, mBar, inHg

Examples of {value} data: 1, 1.0, -5.678, 25.68324e-5

---

## Command Set Definitions

In this manual, a data entry made up of alpha characters is defined as a string, as opposed to data containing only numbers, such as “Enter 1 for ON or 0 for OFF” where 1 and 0 are defined as values.

**Command:** Any command or query listed in a table in chapter **Beamex default command set** on page 55 . For commands that take boolean data the following strings are acceptable:

0	1
False	True
No	Yes
Off	On

**Separator:** Space (SP).

**Data:** ASCII representations of numbers, {value}, or alpha characters, {string}, data as defined above. When sending code a literal variable replaces the brackets and the enclosed character(s) shown in the following examples.

**Termination:** Linefeed (LF) or carriage return (CR) is used to signal the end of a command statement. For IEEE-488.2 operation “EOI” is an acceptable alternative.

Always send commands in one of the following formats:

[Command] [Termination];

[Command] [Separator] [Data] [Termination];

Queries are special instructions in the form:

[Command?] [Termination]

where the question mark, “?”, immediately precedes the terminator.

When a valid query is received, the POC8 will return {data} terminated by CR and LF. Floating point data is returned in the current engineering units in exponential format.

---

## Output Formats

Pressure readings are returned in exponential notation in a format according to the **OUTFORM** command as follows:

<sp> pressure value <cr><lf>

<sp> pressure, units number,STANDBY <cr><lf>

<sp> pressure, pressure rate <cr><lf>

<sp> pressure, minimum peak, maximum peak <cr><lf>

<sp> pressure, active sensor (P or S) active turndown (1-4)<cr><lf>

<sp> pressure, control point, "stable" or "slewing"<cr><lf>

<sp> pressure, "no barometer" or baro reading<cr><lf>

## Commands and Queries

### Beamex default command set

Command or Query	Data	Response/Function
?	See Table Below	Returns data per the current output format
Acquire?	15 char string. Ex:	This command is used when multiple computers would like to control the instrument.
Address	Acquire? Test_stand_1	Sets the GPIB Address
Address?		Returns the GPIB Address
Asset_tag	Returns:	General purpose string for customer use
Asset_tag?	<sp>(YES or NO), CCC... CCC<cr><lf>	Return customer asset tag string
Autorange	0-31	Sets whether the autorange function is enabled or disabled
Autorange?	<sp>nn<cr><lf>	Returns whether the autorange function is enabled or disabled.
Autozero	none	Re-zero all the ranges. These adjustments are not password protected and are saved through power cycles. This command takes approximately 60 seconds but may take longer depending on the time to become stable.
Autozero?	S,T,X,X	Returns autozero data where S represents state (0 = complete, 1 = local autozero, 2 = remote autozero), T represents the estimated time to complete in seconds, and x is a (0) character since this data location is not used at this time.
Autozeroabort	none	Aborts autozero. Any sensors that have been zeroed will not revert to previous zero offsets.
Baro?	<sp>+n.nnnnnE+nn<cr><lf>	Returns reading from barometric module or "NO BAROMETER" if one isn't installed
Calculate_as_found_linearity		Calculate linearity slopes and intercepts from true/actual pressures
Caldisable	YES,NO	Sets whether or not calibration of the active module is disabled.
Caldisable?	<sp>(YES or NO)<cr><lf>	Returns whether or not calibration of the active module is disabled.
Calspan	Current Pressure	Sets the internal span multiplier to achieve the sent pressure. Sending a "?" clears internal span

Calspan?	<sp>+n.nnnnnE+nn<cr><lf>	Returns the span multiplier stored in the active turndown
CalZero	Nnnnnnn	Sets the internal zero to achieve the sent pressure. Sending a “?” clears the internal zero.
CalZero?	<sp>+n.nnnnnE+nn<cr><lf>	Returns the zero offset in psi stored in the active turndown
Cerr	None	Clears the error queue
Chanfunc	Press, peak, rate, rate setpt, dio, units	Sets the secondary display function mode, works identical to Chanfunc2
Chanfunc?	<sp>CCCCC...<cr><lf>	Returns the secondary alternate function mode, works identical to Chanfunc2
Chanfunc2	Press, peak, rate, rate setpt, dio, units	Sets the secondary display function mode
Chanfunc2?	<sp>CCCCC...<cr><lf>	Returns the secondary alternate function mode
Chanfunc3	Press, peak, rate, rate setpt, dio, units	Sets the tertiary display function mode
Chanfunc3?	<sp>CCCCC...<cr><lf>	Returns the tertiary alternate function mode
CID?		Returns the ID string of the controller
Cmdset	Mensor, DPI510, SCPI	Activates remote command set for instrument emulation modes.
Cmdset?	<sp><CCCCCC><cr><lf>	Returns active command set identifier
Control		Instrument placed in Control Mode
Control?	<sp>(YES or NO)<cr><lf>	Returns YES if instrument is in control. NO if otherwise
Crate	Slow, Medium, Fast, Variable	Sets the control rate, Variable mode is a predetermined user defined rate setpt.
Crate?	<sp>CCCCCC<cr><lf>	Returns the control rate – CCCC is variable in length and corresponds to the parameters for the CRATE command
Ctype?		Returns the type of controller
Decpt?	<sp>n<cr><lf>	Returns the number of decimal points (see Resolution)
Default	None	Sets the default values
DHCP	ON or OFF	Reserved for DHCP setup
DHCP?	<sp>(YES or NO)<cr><lf>	Reserved for DHCP setup
DOC?	<sp>mm/dd/yyyy<cr><lf>	Returns the date of cal for the active pressure module.
DOM?	<sp>mm/dd/yyyy<cr><lf>	Returns the date of manufacture
Error?	<sp> text description <cr><lf>	Returns the next error in the error queue



DOC	mm/dd/yyyy	Sets the date of cal for the active pressure module.
Filter	OFF, LOW, NORMAL, HIGH	Sets the reading filter 0, 80%, 92%, 95%
Filter?	<sp>(filter)<cr><lf>	Returns the reading filter.
Gasdensity	Value in lb/cuft, or "NITROGEN" or "DRYAIR"	Sets the head pressure gas density in lb/cuft
Gasdensity?	<sp>+n.nnnnnE+nn<cr>	Returns the serial data bits number
Gastemp	Value in degrees F	Sets the head pressure gas temperature
Gastemp?	<sp>+n.nnnnnE+nn<cr><lf>	Gets the head pressure gas temperature
Gateway	nnn.nnn.nnn.nnn	Sets the Ethernet gateway address
Gateway?	<sp>nnn.nnn.nnn.nnn<cr><lf>	Gets the Ethernet gateway address
Height	Value in inches	Sets the head pressure height in inches
Height?	<sp>+n.nnnnnE+nn<cr><lf>	Gets the head pressure height in inches
Id?	<sp>BEAMEX,POC8, ssssss,v.v.vv<cr><lf>	Ssssss is the serial number,v.v.vv is the POC8 software version.
IP	nnn.nnn.nnn.nnn	Sets the IP address of the instrument
IP?	<sp>nnn.nnn.nnn.nnn<cr><lf>	Returns the IP address of the instrument
Keylock	YES or NO	Locks or unlocks the entire touch screen
Keylock?	<sp>(YES or NO)<cr><lf>	Returns Yes or No
Linearity_pts	n	n = number of linearity points (11 max)
Linearity_pts?	<sp>n<cr><lf>	Returns the number of linearity points
Linearity_seg<sp>[n]	n,f	n = linearity point, f = linearity segment value
Linearity_seg?<sp>[n]	<sp><f><cr><lf>	Returns the segment value for the point
Linearity_slp<sp>[n]	n,f	n = linearity point, f = linearity slope value
Linearity_slp?<sp>[n]	<sp><f><cr><lf>	Returns the segment slope for the point
Linearity_int<sp>[n]	n,f	n = linearity point, f = linearity intercept value
Linearity_int?<sp>[n]	<sp><f><cr><lf>	Returns the segment intercept for the point
List?	<sp>Pri,1;Sec,1;Ter,1;Bar,1<cr><lf>	Returns list of available pressure modules and turn downs. Turn downs are obsolete and therefore set to 1 for backwards compatibility.
Listcal?	<sp>PRI,{sn},1,{mmddy};SEC,{sn},1,{mmddy},TER,{sn},1,{mmddy},Bar,{sn},{mmddy}<cr><lf>	

Listrange?	<sp>PRI,1,min,max;SEC,1,min,max;TER,1,min,max;Bar,min,max	Returns the ranges of the installed measure modules.
Locale	ll_CC	Sets the locale, posix locale names en_US = English, U.S.A. de_DE = German, Germany etc
Locale?	<sp>ll_CC<cr><lf>	Returns the posix locale of the instrument
Localgravity	Value in ft/s <sup>2</sup>	Sets the local gravity in feet/sec <sup>2</sup>
Localgravity?	<sp>+n.nnnnnE+nn<cr><lf>	Returns the local gravity in feet/sec <sup>2</sup>
LowerLimit	Value inside primary xducer range in current units.	Sets the lower control limit for the instrument
LowerLimit?	<sp>n.nnnnnE+nn<cr><lf>	Returns the lower control limit for the instrument in current units.
Measure	None	Instrument placed in Measure Mode
Measure?	<sp>(YES or NO)<cr><lf>	Returns YES if instrument is in measure. NO if otherwise
Mode	STANDBY, MEASURE, CONTROL, VENT	Sets the operation mode
Mode?	<sp>XXXXXX<cr><lf>	Returns the operation mode
Netmask	nnn.nnn.nnn.nnn	Sets the Ethernet network mask
Netmask?	<sp>nnn.nnn.nnn.nnn<cr><lf>	Gets the Ethernet network mask
Options?	<sp>o[,0[,0...]]<cr><lf>	Returns list of installed options
Outform	1 to 7 – see table below	Sets the output format
Outform?	<sp>X<cr><lf>	Returns the output format – see table below
Peakmax?	<sp>n.nnnnnE+nn<cr><lf>	Returns the maximum pressure since peakreset was sent.
Peakmin?	<sp>n.nnnnnE+nn<cr><lf>	Returns the minimum pressure since peakreset was sent.
Peakreset	None	Resets the peak values.
Percent	Value in percent	Sets an exact measure filter percent
Percent?	<sp>n.nnnnnE+nn<cr><lf>	Returns the filter percent
Port	nnnnnn	Sets the Ethernet port of the instrument
Port?	<sp>nnnnn<cr><lf>	Returns the Ethernet port of the instrument
Precision	none	Sets the precision mode: .003% stable window and 4 second stable delay
Ptype	Absolute or Gauge	Sets the instrument pressure type – emulation only works if the optional barometric module is installed
Ptype?	<sp>CCCCC<cr><lf>	Returns “Absolute” or “Gauge” for the pressure type

RangeMax?	<sp>n.nnnnnE+nn<cr><lf>	Returns the maximum range of the active pressure module in the current units.
RangeMin?	<sp>n.nnnnnE+nn<cr><lf>	Returns the minimum range of the active pressure module in the current units.
Rate?	<sp>n.nnnnnE+nn<cr><lf>	Returns the rate reading of the instrument in current units/current time unit (see: Runits)
Rdecpt?	<sp>n<cr><lf>	Returns the number of rate decimal points. (see Resolution)
Reference	{EXTVAC or ATM}	Sets the reference type for vacuum pump connected to the reference, or vented to atmosphere. This option is available only on native gauge units.
Reference?	<sp>{EXTVAC or ATM}<cr><lf>	Returns the current reference type. See: Reference
Release?	15 char string. Ex: Release? Test_stand_1 Returns: <sp>(YES or NO), CCC... CCC<cr><lf>	This command is used to release control of the instrument in a multiple computer environment. Yes if release is successful No if instrument is being controlled with another computer CCC... = name of controlling computer or AVAILABLE See: Acquire? and Unlock
Repeat	None	Repeats output continually over serial port.
Resolution	<n>	Sets the number of significant digits. See: decpt
Resolution?	<sp>n<cr><lf>	Returns the number of significant digits. See: decpt
Rfilter	Value in %	Sets the % of the rate filter
Rfilter?	<sp>n.nnnnnE+nn<cr><lf>	Returns the rate filter.
Rsetpt	Value in current units	Sets the rate setpoint
Rsetpt?	<sp>n.nnnnnE+nn<cr><lf>	Returns the rate setpoint
Runits	Sec, min, hr	Sets the rate time unit
Runits?	<sp>XXXX<cr><lf>	Returns the rate time unit
Rfreq	Value in frequency	Sets rate Butterworth corner frequency
Rfreq?	<sp>n.nnnnnE+nn<cr><lf>	Returns rate Butterworth corner frequency
Rwindow	Value in current units	Sets rate exponential filter window
Rwindow?	<sp>n.nnnnnE+nn<cr><lf>	Returns rate exponential filter window
Save_cal		Save calibration values
Save_linearity		Save linearity values

Sbaud	9600, 19200, 38400, 57600, 115200	Sets the serial baud rate
Sbaud?	<sp>XXXX<cr><lf>	Returns the serial baud data
Sdata	7 or 8	Sets the serial data bits
Sdata?	<sp>n<cr><lf>	Returns the serial data bits number
Sensor	1,2 or PRIMARY, SECONDARY	Sets the active measurement module
Sensor?	<sp>XXXXXXXX,1<cr><lf>	Returns active measurement module in long string format
Setpt	value inside upper and lower limits	Sets the control setpoint for the instrument
Setpt?	<sp>XXXXXXXX<cr><lf>	Returns the control setpoint in current units.
Setpt%	Value in % of current range	Sets the control setpoint in % of current range
Setptpct	Value in % of current range	Sets the control setpoint in % of current range
Setptpct?	<sp>n.nnnnnE+nn<cr><lf>	Returns the current setpoint in % of current range
Span	desired pressure or ?	Sets span on active pressure module or for ?, clears previous value, must be > 50% FS and has a 1% limit. CALDISABLE must be OFF/NO.
Span?	<sp>XXXXXXXX<cr><lf>	Returns span scale factor for active pressure module
Sparity	Even, ODD, NONE	Sets the serial parity
Sparity?	<sp>CCCC<cr><lf>	Returns the serial parity
Srqmask	Stable,Error or both	Sets the POC8 to issue a service request (SRQ) over the IEEE when the pressure Control is stable, or an error occurs. These are 80 hex and 40 hex respectively
Srqmask?	<sp>{string}<cr><lf>	Returns "stable", "error" or "error, stable" depending on the SRQ.
Sstop	1 or 2	Sets the serial stop bits
Sstop?	<sp>X<cr><lf>	Returns the serial stop bits
Stable?		Returns YES if instrument is stable or No
Stabledelay	0 to 65535	Sets the stable time to the number of seconds specified
Stabledelay?	<sp>XXXXXXXX<cr><lf>	Returns the stable time.
stabletime	0 to 65535	Sets the stable time to the number of seconds specified
Stabletime?	<sp>XXXXXXXX<cr><lf>	Returns the stable time.
StableWin	%fs value	Sets the stable window as a %FS
StableWin?	<sp>n.nnnnnE+nn<cr><lf>	Returns the stable window.

Standby	None	Instrument placed in Standby Mode
Standby?	<sp>(YES or NO)<cr><lf>	Returns yes if instrument is in Standby, no if otherwise
Step	Value inside upper and lower limits and inside the range of the active pressure module.	Sets the control step size for the instrument
Step-		Jogs the setpoint down one step
Step+		Jogs the setpoint up one step
Step?	<sp>+n.nnnnnE+nn<cr><lf>	Returns the control step for the instrument
Step%	Value in % of current range	Sets the control step in % of current range
Steppct	Value in % of current range	Sets the control step in % of current range
Steppct?	<sp>n.nnnnnE+nn<cr><lf>	Returns the current step in % of current range
Stop	None	Stop repeating output over serial port – see repeat
Tare	ON / OFF	Tares the reading to zero
Tare?	<sp> n.nnnnnE+nn <cr><lf>	Returns value of Tare
Units	units code or text in table below	Sets the instrument engineering units
Units?	<sp>CCCC<cr><lf>	Returns the instrument units in a text string
Unlock	None	Releases Acquire locks
UpperLimit	Value inside primary xducerRange in current units.	Sets the Upper control limit for the active pressure module.
UpperLimit?	<sp>xxxxxxx<cr><lf>	Returns the upper control limit for the active pressure module.
Vent	None	Instrument placed in Vent Mode
Vent?	<sp>(YES or NO)<cr><lf>	Returns yes if instrument is in Vent, no if otherwise
Volume	Value in cc	sets the system volume in cc's – only applicable for the pump
Volume?	<sp>Xxxxxxx<cr><lf>	Returns the current system volume in cc's
Window	Value in current units	Sets the exponential filter window for the active pressure module
Window?	<sp>n.nnnnnE+nn<cr><lf>	Returns the exponential filter window for the active pressure module
Zero	desired pressure or ?	Sets zero to set pressure or for ?, clears previous value. CALDISABLE must be OFF/NO.
Zero?	<sp>n.nnnnnE+nn<cr><lf>	Returns zero offset for active pressure module

## Units Command Syntax for Measurement Units

n	Description	Output Format	Type
1	pounds per square inch	PSI	Imperial
2	inches of mercury @ 0°C	INHG	Imperial
3	inches of mercury @ 60°F	INHG	Imperial
4	inches of water @ 4°C	INH2C	Imperial
5	inches of water @ 20°C	INH2O	Imperial
6	inches of water @ 60°F	INH2O	Imperial
7	feet of water @ 4°C	FTH2O	Imperial
8	feet of water @ 20°C	FTH2O	Imperial
9	feet of water @ 60°F	FTH2O	Imperial
10	millitorr	MTORR	Metric
11	inches of sea water @ 0°C	INSW	Imperial
12	feet of sea water @ 0°C	FTSW	Imperial
13	atmospheres	ATM	Imperial
14	bars	BAR	Metric
15	millibars	MBAR	Metric
16	millimeters of water @ 4°C	MMH2O	Metric
17	centimeters of water @ 4°C	CMH2O	Metric
18	meters of water @ 4°C	MH2O	Metric
19	millimeters of mercury @ 0°C	MMHG	Metric
20	centimeters of mercury @ 0°C	CMHG	Metric
21	torr	TORR	Metric
22	kilopascals	KPA	Metric
23	pascals	PA	Metric
24	dynes per square	DY/CM <sup>2</sup>	Metric
25	grams per square centimeter	G/CM <sup>2</sup>	Metric
26	kilograms per square	KG/CM <sup>2</sup>	Metric
27	meters of sea water @ 0°C	MSW	Metric
28	ounce per square	OSI	Imperial
29	pounds per square foot	PSF	Imperial
30	tons per square	TSF	Imperial
32	micron of mercury @ 0°C	mHG	Metric
33	tons per square	TSI	Imperial
34	hectapascals	HPA	Metric
36	megapascals	MPA	Metric
37	millimeters of water @ 20°C	MMH2O	Metric
38	centimeters of water @ 20C	CMH2O	Metric
39	meters of water @ 20°C	MH2O	Metric

## Error Codes

Code	Serial Poll Byte	Description	Error String Returned
E00	00h	No errors	NO ERRORS
E05	45h	Parameter error	EGPIB PARAMETER ERROR: <String that was sent>
E07	47h	Syntax error	EGPIB SYNTAX ERROR: <String that was sent>

## SCPI Commands and Queries

Except for the engineering units selection, the numeric suffix selects the applicable channel/sensor:

- 1= Channel A
- 2= Barometer (if installed)

This numeric suffix always defaults to 1 and is designated by [C] (channel)

Command	Response/Function
STATus	
:OPERation	
:CONDition?	Returns an integer value representing instrument status that can be decoded. Bit 0: Zeroing active Bit 1: Control Setpoint has not been reached. Bit 2: Reserved 0. Bit 3: Reserved 0. Bit 5: Measuring. The instrument is actively measuring
MEASure	
[:PRESSure][R]?	Returns the pressure from range R
:TEMPerature[R]?	Returns the temperature from range R
:RATE[R]?	Returns the rate/sec from range R
:BAROmetric?	Returns the barometric pressure
CALibration	
[:PRESSure][R]	
MODE?	Returns 1=calibrated or 0=not calibrated
:DATE?	Returns date of cal "MM/DD/YY"
:DATE <i,i,i>	Sets date of cal YYYY,MM,DD
:ZERO?	Returns zero offset
:ZERO <n>	Sets the zero offset
:ZERO:RUN	Start Autozero sequence
:ZERO:STOP	Stop Autozero sequence
:ZERO:INITiate?	Returns zero status
:ZERO:INITiate	Ignored
SENSe	

Command	Response/Function
[:PRESSure][R]	
:NAME?	Returns transducer name string
:MODE?	Returns "ABSOLUTE" or "GAUGE"
:MODE ABS   GAUGE	Sets pressure type
:ABS?	Returns native transducer type 0=GAUGE 1=ABSOLUTE
:RESolution?	Returns resolution (float)
:RANGe	
[:UPPer]?	Returns maximum range
:LOWer?	Returns minimum range
:UNIT	
[:NAME]?	Returns ASCII units (mixed case)
:VALue?	Returns the units conversion factor
:REFerence	
[:HEIGht] <n>	Sets the head pressure height
:HEIGht?	Returns the head pressure height
:MODE?	Returns "OFF", "DRYAIR", or "NITROGEN"
:MODE OFF     HELIUM   DRY AIR     NITROGEN	Sets the head pressure mode
:MEDium<n>	Sets the medium density
:MEDium?	Returns medium
:ACTive <n>	Sets the active transducer
ACTive?	Returns the active transducer
SYSTem	
:DATE <i,i,i>	Not used, kept for backwards compatibility
:DATE?	Not used, does not cause an error, does not return a response
:TIME <i,i,i>	Not used, kept for backwards compatibility
:TIME?	Not used, does not cause an error, dose not return a response
:ERRor[:NEXT]?	Returns error code, description
:KLOCK ON   OFF   1   0	Sets the keylock state
:PRESet	Load known state values
:SAVe	No function (not needed)
:VERSion?	Returns SCPI version 1994.0
TEST	
:ELECTronic?	Returns "OK"
:RELay<n>?	Returns status of digital output <n>



Command	Response/Function																																														
:RELAy<n> ON   OFF	Turns the digital output on or off <n>																																														
UNIT																																															
:[PRESSure] bar   mbar   Pa     psi	Sets the pressure units																																														
: [PRESSure]?	Returns the pressure units																																														
:NAME<n>?	Returns the units string for units code <n>																																														
:FACTor <n>?	Returns the units conversion for units code <n>																																														
:INDEX <n>	Sets the index number.																																														
:INDEX?	<p>Returns the index number.</p> <table border="1"> <thead> <tr> <th><u>index unit</u></th> <th><u>index unit</u></th> </tr> </thead> <tbody> <tr><td>0 bar</td><td>21 OSI</td></tr> <tr><td>1 mbar</td><td>22 TSI</td></tr> <tr><td>2 Pa</td><td>23 TSF</td></tr> <tr><td>3 psi</td><td>24 ftH2O(20°C)</td></tr> <tr><td>4 atm</td><td>25 ftH2O(60°F)</td></tr> <tr><td>5 kp/cm2</td><td>26 inSW</td></tr> <tr><td>6 lbf/ft2</td><td>27 ftSW</td></tr> <tr><td>7 kPa</td><td>28 hPa</td></tr> <tr><td>8 cmH2O(4°C)</td><td>29 Mpa</td></tr> <tr><td>9 inH2O(4°C)</td><td>30 dyn/cm2</td></tr> <tr><td>10 inH2O(60°F)</td><td>31 mHg 0°C</td></tr> <tr><td>11 ftH2O(4°C)</td><td>32 Torr</td></tr> <tr><td>12 µmHg(0°C)</td><td>33 mTorr</td></tr> <tr><td>13 mmHg(0°C)</td><td>34 uHg 0°C</td></tr> <tr><td>14 cmHg(4°C)</td><td>35 mmH2O 4°C</td></tr> <tr><td>15 inHg(0°C)</td><td>36 mH2O 4°C</td></tr> <tr><td>16 inHg(60°F)</td><td>37 mmH2O 20°C</td></tr> <tr><td>17 - -</td><td>38 cmH2O 20°C</td></tr> <tr><td>18 user</td><td>39 mH2O 20°C</td></tr> <tr><td>19 user</td><td>40 mSW</td></tr> <tr><td>20 user</td><td>41 g/cm2</td></tr> <tr><td></td><td>42 Kg/m2</td></tr> </tbody> </table>	<u>index unit</u>	<u>index unit</u>	0 bar	21 OSI	1 mbar	22 TSI	2 Pa	23 TSF	3 psi	24 ftH2O(20°C)	4 atm	25 ftH2O(60°F)	5 kp/cm2	26 inSW	6 lbf/ft2	27 ftSW	7 kPa	28 hPa	8 cmH2O(4°C)	29 Mpa	9 inH2O(4°C)	30 dyn/cm2	10 inH2O(60°F)	31 mHg 0°C	11 ftH2O(4°C)	32 Torr	12 µmHg(0°C)	33 mTorr	13 mmHg(0°C)	34 uHg 0°C	14 cmHg(4°C)	35 mmH2O 4°C	15 inHg(0°C)	36 mH2O 4°C	16 inHg(60°F)	37 mmH2O 20°C	17 - -	38 cmH2O 20°C	18 user	39 mH2O 20°C	19 user	40 mSW	20 user	41 g/cm2		42 Kg/m2
<u>index unit</u>	<u>index unit</u>																																														
0 bar	21 OSI																																														
1 mbar	22 TSI																																														
2 Pa	23 TSF																																														
3 psi	24 ftH2O(20°C)																																														
4 atm	25 ftH2O(60°F)																																														
5 kp/cm2	26 inSW																																														
6 lbf/ft2	27 ftSW																																														
7 kPa	28 hPa																																														
8 cmH2O(4°C)	29 Mpa																																														
9 inH2O(4°C)	30 dyn/cm2																																														
10 inH2O(60°F)	31 mHg 0°C																																														
11 ftH2O(4°C)	32 Torr																																														
12 µmHg(0°C)	33 mTorr																																														
13 mmHg(0°C)	34 uHg 0°C																																														
14 cmHg(4°C)	35 mmH2O 4°C																																														
15 inHg(0°C)	36 mH2O 4°C																																														
16 inHg(60°F)	37 mmH2O 20°C																																														
17 - -	38 cmH2O 20°C																																														
18 user	39 mH2O 20°C																																														
19 user	40 mSW																																														
20 user	41 g/cm2																																														
	42 Kg/m2																																														
OUTPut																																															
:STATe ON   OFF   1   0	ON or 1 = Control OFF or 0 = Measure																																														
:STATe?	Returns 0 for measure 1 for control																																														
:MODE MEASure   CONTROL     VENT	Sets the mode indicated																																														
:MODE?	Returns the mode string																																														
:STABLE?	Returns 1 if stable 0 if not																																														
:AUTOvent ON   OFF   1   0	Autovent is always true on CPC4000																																														
:AUTOvent?	Returns the state of the Vent mode																																														
:AUTORange ON   OFF   1   0	Turns autorange on or off																																														

Command	Response/Function
:AUTORange?	Returns "ON" or "OFF"
[SOURce]	
:PRESsure	
[:LEVel]	
[:IMMediate]	
[:AMPLitude] <n>	Sets the setpoint
[:AMPLitude]?	Returns the setpoint
:RSETPT <n>	Sets the rate setpoint in current units
:RSETPT?	Returns the rate setpoint in current units
:SLEW <n>	Sets the rate setpoint in %FS/sec
:SLEW?	Returns the rate setpoint in %FS/sec
:TOLerance?	Returns the stable window
:TOLerance<n>	Sets the stable window
CALCulate	
:LIMit	
:LOWer<n>	Set the minimum control limit
:LOWer?	Returns the minimum control limit
:UPPer<n>	Set the maximum control limit
:UPPer?	Returns the maximum control limit
:SYSTem	
:DETECT SLOW   FAST     CANCEL	Not used, kept for backwards compatibility
:DETECT?	Returns "0"

## GPIB Capability Codes

All remote commands sent to the POC8 are shown in the Trouble Shooting view, under the "Remote" button. If there is a syntax error, an error message will appear below the errant command. Local errors and remote command errors will appear under the "Error" button. Maximum of 100 errors are stored and can be retrieved.

## GPIB Capability Codes

SH1	Full source handshake capability
AH1	Full acceptor handshake capability
T6	Talker with serial poll and unaddress if MLA
L4	Listener with unaddress if MTA
SR1	Full service request capability
L1	Full remote/local capability including LLO
PO	No parallel poll capability
DC1	Full device clear capability
DT1	Full device trigger capability

C0	No controller capability
E2	Tri-state outputs

## Interface Functions

POC8 responds to the following IEEE.488.2 interface functions:

- SRQ Service Request: A service request is asserted whenever an error is encountered. When the bus controller issues a serial poll the error will be cleared. If the host IEEE board includes automatic serial polling capability, turn this feature off in order to view all errors.
- LLO Local Lockout: The front panel keyboard of the device may be locked by sending LLO or the command KEYLOCK ON.
- GET Group Execute Trigger: When this message is received, the device will save the current readings until the next time it is addressed as a talker.
- GTL Go To Local: A GTL message will cause the device to return to local operation and unlock the keyboard.
- DCL Device Clear: When this message is received, the device will clear all errors and buffers and remain in the Remote mode.
- SDC Selected Device Clear: The effect is the same as DCL.
- EOI End or Identify: May be used as a command or query terminator in the place of, or concurrent with, a terminating linefeed.

## USB Software Upgrade

The instrument software can be upgraded to the most recent release by copying the instrument software from the Beamex website onto a USB device. The user can then plug the USB device to the USB port on the front panel of the instrument for an easy upgrade. The instrument recognizes this device by displaying a USB icon on the top bar of the screen (uppermost picture below). The user can navigate to the Software upgrade menu by clicking on the USB icon. The software upgrade menu gives the user information on the current instrument software and the version of instrument software on the USB device (lowermost picture below).

The user can load the instrument software from the USB to the instrument by clicking on the desired version and then clicking [  ] button. The status of the installation can be seen on right one fourth of the screen.

The user also has the option to copy and load program test sequences from the USB drive which can later be accessed through the Programs view menu.



Home View with USB Icon.

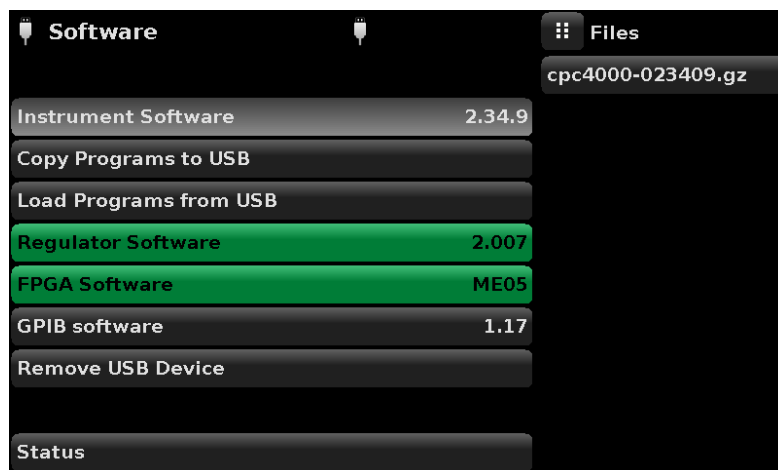

Software Upgrade Menu.

# Options

- Barometric Module (for gauge and absolute emulation) (9891930)
- Additional Measurement Module
  - 350 mbar / 5 psi (9891860)
  - 1 bar / 14.5 psi (9891870)
  - 6 bar / 87 psi (9891880)
  - 20 bar / 290 psi (9891890)
  - 100 bar / 1450 psi (9891900)
  - 210 bar / 3045 psi (9891910)
  - Special range, contact Beamex (9891920)
- Bench Mounting Kit (9891850)
- Pressure hose for output pressure
  - T-hose set with connectors for low pressure (8009550)
  - Extension hose (straight) for low pressure (8009560)
  - T-hose set for high pressure (8170200)
  - Hose set (straight) for high pressure (8003365)
- Vacuum pump
  - Vacuum Pump 110 V (9427110)
  - Vacuum Pump 230 V (9427230)
  - Vacuum pump switch set for panel (9972405)
  - Swivel stand for vacuum pump (9972410)
- Contamination Prevention Accessories
  - DMT40 Dirt and Moisture Trap for max. 40 bar / 580 psi (9010900)
  - DMT210 Dirt and Moisture Trap for max. 210 / 3050 psi pressure (9010910)

---

## Barometric Module

The Barometric Module is an absolute pressure module used to accurately measure local atmospheric pressure. This module is in a different housing compared to the regular modules. It is removable by taking off the top cover of the chassis.

The POC8 uses the barometric pressure, measured by the barometric module, for pressure mode emulation in the channels. If a barometric module is installed the Pressure Mode button in the Home view (main screen) will become active and, when pressed, will toggle between Absolute and Gauge mode (see chapter **Home View** on page 18). The barometer reading can also be read at the bottom of the buttons in the Home view.

### Gauge Pressure Emulation

In the Home view (main screen) an absolute pressure module channel will indicate “Absolute” in the mode button (this is the default mode). When this button is pressed the button label will toggle to “Gauge” and have a lighter background color. The lighter background color is an indication that the channel is in emulation mode.

In the gauge emulation mode the atmospheric pressure reading from the barometric reference module is subtracted from the absolute pressure reading to emulate a gauge pressure.

### Absolute Pressure Emulation

In the Home view (main screen) a gauge pressure module channel will indicate “Gauge” in the mode button (this is the default mode). When this button is pressed the button label will toggle to “Absolute” and have a lighter button background color. The lighter background color is an indication that the channel is in emulation mode.

In the absolute emulation mode the atmospheric pressure reading from the barometric module is added to the gauge pressure reading to emulate an absolute pressure.

### Emulation Mode Accuracy

The accuracy in emulation mode is different for gauge and absolute emulation mode.

The barometric module has six significant digits and has a guaranteed drift of 0.0002827 mbar / 0.0000041 psi over a 24 hour period which has no significant effect on the emulated gauge pressure uncertainty.

The absolute uncertainty of the barometric module must be considered in the emulated absolute pressure uncertainty.

### Calibration of the Barometric Module

The Barometric Module can be calibrated in exactly the same manner as the other installed modules as described in section Calibration.

### Specifications of the Barometric Module

Accuracy: 0.02% of reading. Uncertainties include all pressure effects, temperature effects over the calibrated range and calibration stability for 365 days after re-zeroing.

Pressure Range: The standard Barometric Module is calibrated from 0.55 to 1.17 bara / 8 to 17 psia. Resolution: 6 digits.

---

## Additional measurement modules

A secondary measurement module of any standard range, can be purchased as an option. In all other regards, the add-on module will meet all of the specifications and operating parameters outlines throughout this manual.



**Caution**

Typically, the pressure control unit in each device has limits of 10, 100 or 210 barg / 150, 1500 or 3,045 psig. If a measurement module is placed into a device where the control unit has a higher upper pressure range, the maximum control limit will be limited to the maximum range of the measurement module.

While any measurement module will function in any device, the results may not always be optimum. For example, if a 1 bar / 14.5 psi module is placed in a device that has a 100 bar / 1500 psi upper limit, the controlled pressure stability may not be acceptable.

## Secondary measurement module installation

If the add-on measurement module is of a higher full scale range than the existing primary module, then this newer module becomes the Primary, and the existing module must be moved to the Secondary Module slot. For complete installation instructions see chapter **Removing the measurement module** on page 73.

---

## Bench Mounting Kit

A rack mount kit is used to install POC8 into Beamex MCS200 Calibration Workstation.

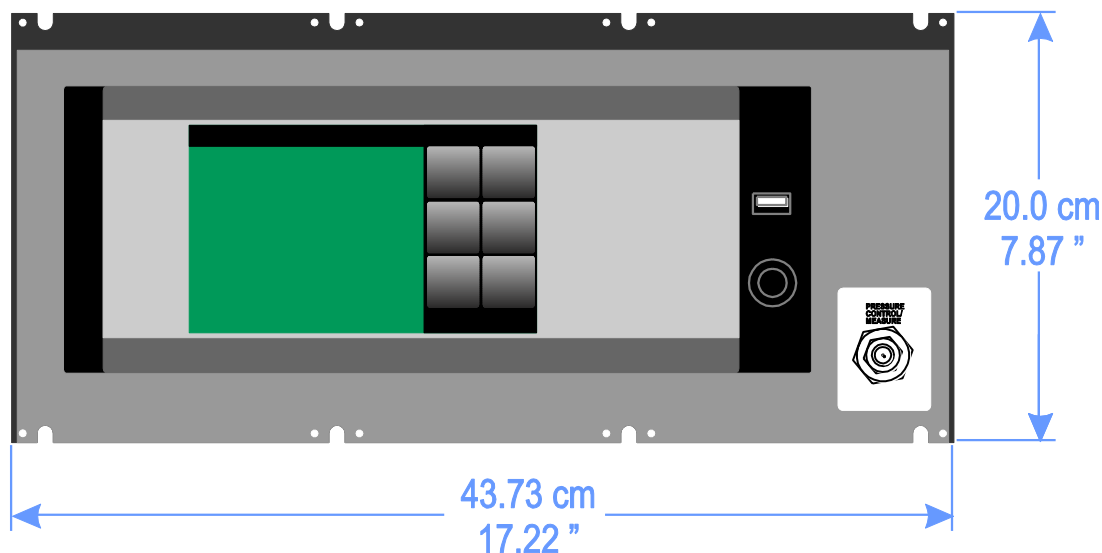

*POC8 Rack Mount Kit.*

See also Appendix, chapter **Installing POC8 to MCS200 Module Rack** on page 86.

---

## Fittings

POC8 is delivered with proper pressure connectors and hoses for supply pressure and vacuum. The Barometric Module comes with a standard Barb fitting.

---

## Re-calibrating

We recommend having the system re-calibrated by the manufacturer at regular intervals of approximately 12 months. Every re-calibration at the factory also includes a comprehensive and free checking of all system parameters.

POC8 requires almost no maintenance, because all moving parts are extremely robust. There are no parts which have to be serviced by the user.

During each re-calibration the function of the integrated relief valves are checked.

Please contact Beamex when it is time to re-calibrate your POC8.

If you have installed POC8 in MCS200 module rack, check chapter **Installing POC8 to MCS200 Module Rack** on page 86 to get an overview how to remove your POC8 from the module rack. No pressure tubes or communication cables etc. need to be sent to Beamex when doing a recalibration, only the main unit. Disconnect all tubes and cables, loosen clamps and remove front panel plate. Then push out the main unit.

---

## Dirt and Moisture Trap

Beamex Dirt and Moisture trap allow the user to operate POC8 in contamination prone areas. It prevents in > 90 % efficiency contaminants like any liquids, oil or dirt to enter POC8 when the direction of pressure flow is from device under test (DUT) to POC8 or when the device under test is vented.



# Maintenance

POC8 is designed for maintenance-free operation. User maintenance is not recommended. If you have questions not covered by this manual, please contact Beamex.

---

## Removing the measurement module

Follow the following instructions for removing or replacement the measurement module:

1. VENT THE SYSTEM by placing the device in vent mode. Then turn off the power.
2. Loosen the five Phillips screws on the top cover of the device as seen in picture "Top view of POC8" below and open the top cover to reveal the insides of the chassis (picture "Chassis assembly").
3. Unscrew the thumb screw holding in the measurement module (lowermost picture below).
4. Apply a light inward pressure against the bottom of the module case, just below the range label, while tilting the case upward to clear the clamp plate and screw head.
5. Pull the module outward, through the top opening.



**Caution**

**There must be a measurement module installed in the "Primary Module" slot for the system to function properly. If the system is operated with the primary slot empty the system will display an error.**



*Top view of POC8.*

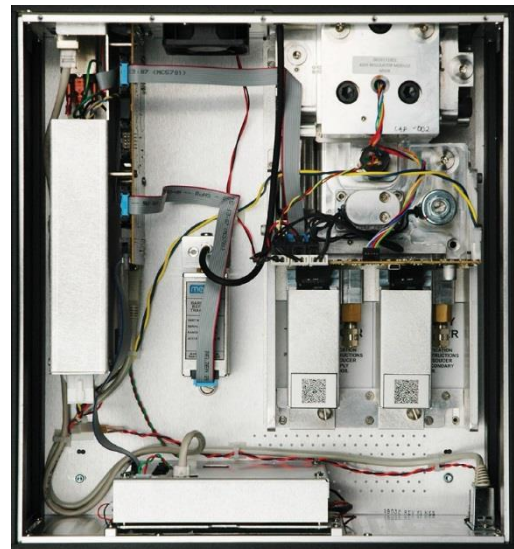

*Chassis assembly.*



*Measurement Module.*



**Caution**

Further access to the interior of the device is **NOT** recommended. There are no user-serviceable plumbing or parts inside. In addition to the dangerous voltages present (line voltage), there are circuits sensitive to electrostatic discharge damage.



**ESD PROTECTION REQUIRED!** The proper use of grounded work surfaces and personal wrist straps are required when coming into contact with exposed circuits (printed circuit boards) to prevent static discharge damage to sensitive electronic components.



**Warning**

If faults cannot be corrected locally, immediately take the system off line and protect it from unintentional restarts. Contact Beamex for further instructions.

Servicing of electrical, electronic or pneumatic equipment must be performed by qualified and authorized technical staff, observing all relevant safety regulations.

## Troubleshooting

Problem / Type of Fault	Correction
The device has been switched on and no measurement(s) have appeared and the entire area of the screen is white (or dark).	Switch the device off. Wait 5 seconds and switch the device on.
The screen is dark and the corrective action for #1 above has no effect.	Check that the power cable is connected properly and have authorized technical staff check that the supply voltage is correct.
The screen is dark and the action taken to solve the problem of #2 above has no effect.	Unplug the unit from the power source (wall socket), then remove the power cord from the instrument. The power cord input socket includes two internal fuses. Check both fuses for continuity.   <b>WARNING! When needed, use only 1.25 amp 250V SLO-BLO 5x20 Fuse.</b>
Malfunction during operation.	Switch the device off. Wait 5 seconds and switch the device on.
Unstable control.	Consult Beamex.
The setpoint value is not reached.	Check whether the value of the supply pressure is the value required, and leak test the plumbing.

# Calibration

The POC8 automatically adjusts the pressure reading for the effects of temperature and nonlinearity within the calibrated temperature range of 15 - 45°C. The process is referred to as dynamic compensation because each reading is so adjusted before it is output to the display or to a communication bus. Thus, a calibrated device operated within its temperature band, and with proper zero and span adjustments, will provide accurate pressure measurements.

The POC8 should have the calibration verified periodically to insure stability. The recommended calibration cycle is one year or six months depending on the pressure module range.

---

## Environment

For maximum accuracy, allow the device to warm up a minimum of 15 minutes in ambient temperature within the compensated range prior to a calibration. In addition, the device should be at rest on a stable platform that is free of excessive vibration and shock.

---

## Pressure Standards

It is recommended to use appropriately accurate primary pressure standards when calibrating this instrument. Such standards should be sufficient so that when the techniques of the ISO Guide to the Expression of Uncertainty in Measurement (GUM) are applied, the device meets its accuracy statements as required by ISO/IEC 17025:2005, or other applicable standards.

---

## Media

The recommended calibration medium is dry nitrogen or clean dry instrument air. A height variation between the standard and the POC8 can cause significant errors. A calculation should be made to compensate for this difference. This compensation can be done as presented in chapter **Head Pressure** on page 81.

## Service View (unlocked)

The Service view can be accessed and unlocked by following the instructions in chapter **Service View** on page 47. The unlocked Service view will appear (see picture below). To re-lock this screen, press the Lock button.



*Unlocked Service view.*

From the unlocked Service view, the Password can be changed by pressing the Enter button next to the Change Password label. This will open a keypad where a new password can be entered and accepted by pressing the Check [  ] button.





### Notice

**Please make note of a password change and save the new password in a secure location.**

The Unlocked Service view is the access point to all calibration screens described further on.

## Calibration Data

The Calibration Data view [  ] is where the calibration data for each measurement module is stored and amended. The Serial number (S/N), Zero offset (Zero) and Span offset (Span) can be seen in this screen. The date of calibration, the calibration interval and the certificate number can be entered by pressing the corresponding button, then saved by pressing the Check [  ] button. To revert back to the factory calibration, press the “Restore Factory Cal” button. To view the calibration data for each module press the “Channel” button at the top and choose a module from the resulting channel selection menu.

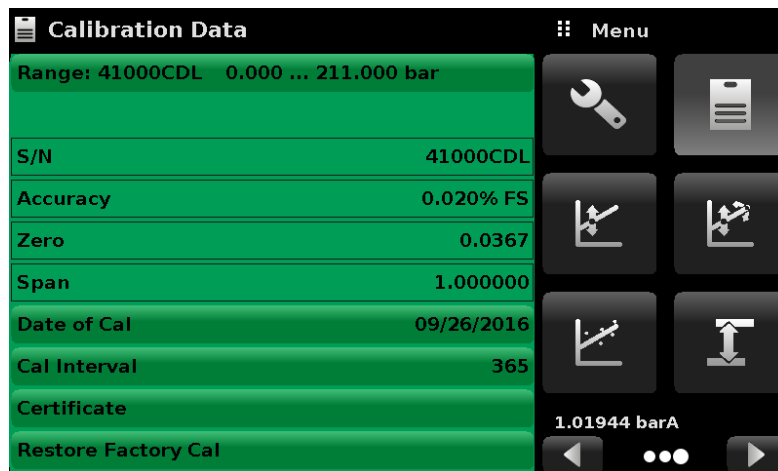

Calibration Data.

## One Point Calibration

A Single Point Calibration [  ] (usually a zero point calibration) of each measurement module installed can be accomplished in “One Point Cal” tool. The module channel is chosen by pressing the “Channel” button at the top of this screen, and then selecting from the list of installed module channels. For gauge pressure simply expose the reference and the pressure port of the module to atmospheric pressure and then press the “New Value” button and enter zero (0) using the keypad. For an absolute module apply a known reference pressure to the pressure port of the pressure module, press the “New Value” button and then enter the reference pressure (known true pressure) using the keypad. If you want to save the value in the module, press Save.



Notice the reference symbol [  ]. This is a reference indication giving a constant reference point for the level of the internal sensor.

One point calibration.

## Two Point Calibration

Two Point Calibration [  ] provides a place to adjust the measurement module Zero and Span (sometimes referred to as the offset and slope).



*Two Point Calibration.*

Follow the steps below for a complete 2 Point Calibration:

Select a measurement module to calibrate by pressing the Channel button at the top of the screen.

### To calibrate the “Low Point”:

1. The pressure port of the module being calibrated should be supplied with a suitable, “low point” pressure (see chapter **Rear Panel** on page 13 for the port location).
2. For a gauge module(s), this low point pressure can be achieved by opening the pressure and reference ports to atmospheric pressure.
3. For an absolute module(s) a suitable source of vacuum should be applied to the Pressure port along with a high accuracy vacuum standard or a pressure calibration standard can be connected to the Pressure port that can generate and measure a pressure value. In either case the pressure should be measured at a stable value that is within 20% of the minimum range of the selected internal pressure module.
4. When the pressure is stable, record the live reading shown on the Two Point Cal screen and enter this value as the “Low Reading” by pressing the Low Reading button and entering the number followed by the Check [  ] button. Record the “true pressure” obtained from the reference standard and enter it as the “Low Reference” value in the same manner.

### To calibrate the "High Point":

1. The "High Point" Calibration is done in a similar way as the "Low Point".
2. Supply a pressure to the Pressure Port of the module being calibrated, using a pressure standard. This pressure should be as close as possible to the full scale value of the selected pressure module or at least within 20% of that value.
3. After the pressure stabilizes, record live reading shown on the Two Point Cal screen and enter this value as the "High Reading" by pressing the High Reading button and entering the number followed by the Check [  ] button. Record the "true pressure" obtained from the reference standard and enter it as the "High Reference" value in the same manner.
4. After all four values (High Reference, High Reading, Low reference, & Low reading) have been entered, the Adjust button will become active. Press the Adjust button to check and accept the calibration data then press the Save button. The instrument will then prompt with the question "Save Cal Data?" Pressing the check button [  ] in this screen will save the calibration to the memory of the module.

## Linearization

The Linearize Tool [  ] provides a place to record upscale and downscale calibration data and to linearize each transducer using that data. An "as found calibration" can be performed by connecting a suitable pressure standard to the Pressure port of the measurement module being calibrated, and supplying up to 11 pressure points across the complete range. The record of the pressures from the pressure standard and the corresponding reading from the devices' module can be recorded and transcribed into the Linearization Matrix. Linearization of each measurement module can be performed from this screen by selecting module channel using the channel button in the top left hand corner.

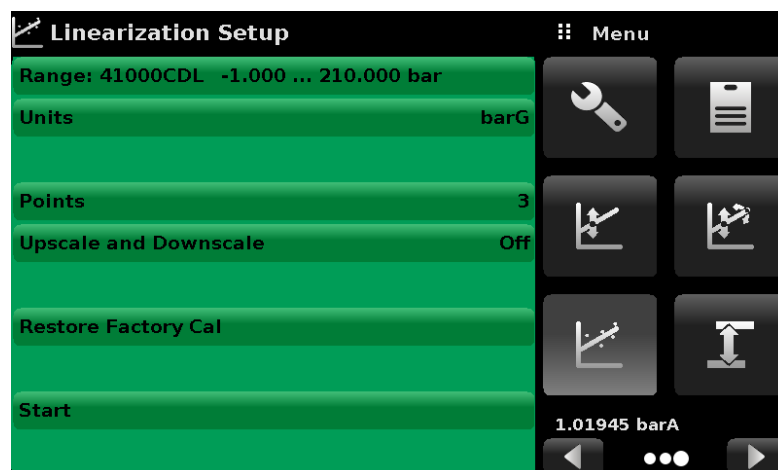

*Linearization Setup.*

The Linearization view automatically populates the screen with 10% increments from the low to high pressure corresponding to the range of the pressure module selected. These values can be changed to reflect the values generated by the standard and the corresponding readings taken from the POC8. Each value from the standard can be entered under the reference column, corresponding Upscale and Downscale readings from the device can be entered in the “Upscale” and “Downscale” columns. To enter a value simply press the number and a key pad will appear (see picture below) where the number can be entered. Press the check button [  ] to accept each value. The “Average” column automatically averages the upscale and downscale values.

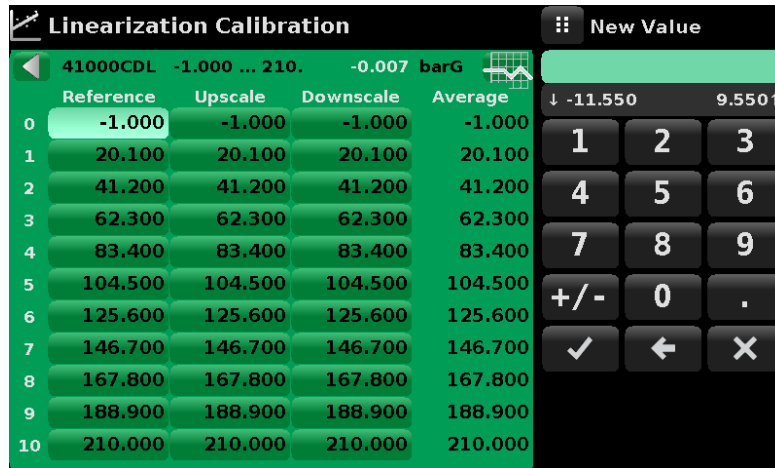

Reference	Upscale	Downscale	Average
0	-1.000	-1.000	-1.000
1	20.100	20.100	20.100
2	41.200	41.200	41.200
3	62.300	62.300	62.300
4	83.400	83.400	83.400
5	104.500	104.500	104.500
6	125.600	125.600	125.600
7	146.700	146.700	146.700
8	167.800	167.800	167.800
9	188.900	188.900	188.900
10	210.000	210.000	210.000

*Linearization Values.*

The picture above shows some typical values that might be seen in a linearization calibration. In the top right of the Operating Screen is the Graph Icon [  ] that, when pressed, reveals a Linearization Error Graph that gives a visual representation of the errors associated with the values entered in the Linearization screen.

This Linearization error graph shows a scaling that corresponds to the maximum error calculated from the data entered in the Linearization Matrix. It is a good indication of the overall error of the module, and will quickly reveal any gross data entry errors that have been made. To revert back to the Linearization Matrix press the Matrix Icon [  ].

When satisfied that all values have been entered correctly, press the adjust button and then the save button to save the new calibration data in the transducer memory.



**Notice**

**After calibration is complete, return to the Calibration Data View (chapter Calibration Data on page 77) to record the certificate number, calibration interval and the date of calibration. Restoration to factory calibration can also be completed in this view.**



## Head Pressure

The Head Pressure view [  ] provides an automated way to calculate the head pressure offset between a device being tested and the POC8, based on:

- Height: the difference between the device under test and the sensing element in the measurement module inside the POC8
- Gas Density: the media density of the pressure media
- Gas Temperature
- Local Gravity

The Head Pressure view is placed under the password protected area of the operator interface to safeguard against inadvertent activation. It is intended to be used to accurately measure the pressure at an external source that is at a different elevation from the POC8 measurement module sensing that pressure.

The four parameters are used to calculate the pressure that is a result of the different elevations. It should not be used when calibrating POC8. Before calibrating the Head height should be set at zero.



**Notice**

**The Head Pressure should not be active when calibrating POC8 measurement modules. Before calibrating the Head height should be set at zero. Difference in height between the laboratory standard and the POC8 during calibration should be factored into the uncertainty analysis.**

The picture below shows the Head Pressure screen. The height, gas density (Nitrogen or dry air), gas temperature and local gravity can be entered here based on the specific setup of the system.

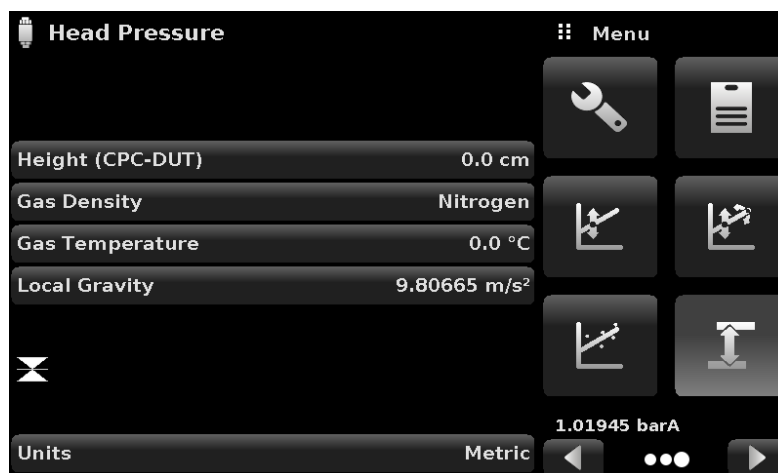

*Head Pressure, Pneumatic.*

# Appendix

## Measurement Units

Code	Description	Output Format
1	pounds per square inch	PSI
2	inches of mercury @ 0°C	inHg 0°C
3	inches of mercury @ 60°F	inHg 60°F
4	inches of water @ 4°C	inH2O 4°C
5	inches of water @ 20°C	inH2O 20°C
6	inches of water @ 60°F	inH2O 60°F
7	feet of water @ 4°C	ftH2O 4°C
8	feet of water @ 20°C	ftH2O 20°C
9	feet of water @ 60°F	ftH2O 60°F
10	millitorr	mTorr
11	inches of seawater @ 0°C 3.5% salinity	inSW
12	feet of seawater @ 0°C 3.5% salinity	ftSW
13	atmospheres	ATM
14	bars	bar
15	millibars	mbar
16	millimeters of water @ 4°C	mmH2O 4°C
17	centimeters of water @ 4°C	cmH2O 4°C
18	meters of water @ 4°C	mH2O 4°C
19	millimeters of mercury @ 0°C	mmHg 0°C
20	centimeters of mercury @ 0°C	cmHg 0°C
21	torr	torr
22	kilopascals	kPa
23	pascals	Pa
24	dyne per square centimeter	Dy/cm2
25	grams per square centimeter	g/cm2
26	kilograms per square centimeter	kg/cm2
27	meters of seawater @ 0°C 3.5% salinity	MSW
28	ounce per square inch	OSI
29	pounds per square foot	PSF
30	tons per square foot	TSF
31	percent of full scale	%FS
32	micron HG @ 0°C	μHg 0°C
33	ton per square inch	TSI
34	n/a	n/a
35	hectopascals	hPa
36	megapascals	MPa
37	millimeters of water @ 20°C	mmH2O 20°C
38	centimeters of water @ 20°C	cmH2O 20°C
39	meters of water @ 20°C	mH2O 20°C
n/a	User Units 1	User defined

## Conversion Factors, PSI

The values listed in the column "To convert from PSI" are the values embedded in the instrument program. The values listed under "To convert to PSI" are internally calculated approximations based on the embedded values.

Code	Pressure Unit	To convert from PSI	To convert to PSI
1	PSI	1	1
2	inHg 0°C	2.036020	0.4911544
3	inHg 60°F	2.041772	0.4897707
4	inH2O 4°C	27.68067	0.03612629
5	inH2O 20°C	27.72977	0.03606233
6	inH2O 60°F	27.70759	0.03609119
7	ftH2O 4°C	2.306726	0.4335149
8	ftH2O 20°C	2.310814	0.4327480
9	ftH2O 60°F	2.308966	0.4330943
10	mTorr	51715.08	0.00001933672
11	inSW 0°C 3.5% salinity	26.92334	0.03714250
12	ftSW 0°C 3.5% salinity	2.243611	0.445710
13	ATM	0.06804596	14.69595
14	bar	0.06894757	14.50377
15	mbar	68.94757	0.01450377
16	mmH2O 4°C	703.0890	0.001422295
17	cmH2O 4°C	70.30890	0.01422295
18	mH2O 4°C	0.7030890	1.422295
19	mmHg 0°C	51.71508	0.01933672
20	cmHg 0°C	5.171508	0.1933672
21	torr	51.71508	0.01933672
22	kPa	6.894757	0.1450377
23	Pa	6894.757	0.0001450377
24	Dy/cm2	68947.57	0.00001450377
25	g/cm2	70.30697	0.01422334
26	kg/cm2	0.07030697	14.22334
27	MSW 0°C 3.5% salinity	0.6838528	1.462303
28	OSI	16	0.0625
29	PSF	144	0.006944444
30	TSF	0.072	13.88889
31	%FS	(PSI / RANGE) x 100	(% FS x RANGE) / 100
32	μHg 0°C	51715.08	0.00001933672
33	TSI	0.0005	2000
35	hPa	68.94757	0.01450377
36	MPa	0.006894757	145.0377
37	mmH2O 20°C	704.336	0.001419777
38	cmH2O 20°C	70.4336	0.01419777
39	mH2O 20°C	0.704336	1.419777

## Conversion Factors, millitorr

The following table lists factors which should be used as multipliers when converting other pressure units to or from millitorr.

Code	Pressure Unit	To convert from millitorr	To convert to millitorr
1	PSI	0.0001933672	51715.08
2	inHg 0°C	0.00003936995	25400.08909
3	inHg 60°F	0.00003948117	25328.53093
4	inH <sub>2</sub> O 4°C	0.0005352534	1868.273977
5	inH <sub>2</sub> O 20°C	0.0005362028	1864.966281
6	inH <sub>2</sub> O 60°F	0.0005357739	1866.458778
7	ftH <sub>2</sub> O 4°C	0.00004460451	22419.25773
8	ftH <sub>2</sub> O 20°C	0.00004468356	22379.59744
9	ftH <sub>2</sub> O 60°F	0.00004464783	22397.50637
10	mTorr	1.0	1.000000022
11	inSW 0°C 3.5% salinity	0.0005206091	1920.827359
12	ftSW 0°C 3.5% salinity	0.00004338408	23049.92831
13	ATM	0.000001315786	760002.2299
14	bar	0.000001333220	750063.6259
15	mbar	0.001333220	750.0636259
16	mmH <sub>2</sub> O 4°C	0.0135954	73.5540997
17	cmH <sub>2</sub> O 4°C	0.001359544	735.5409971
18	mH <sub>2</sub> O 4°C	0.00001359544	73554.09971
19	mmHg 0°C	0.001	1000.000022
20	cmHg 0°C	0.0001	10000.00022
21	torr	0.001	1000.000022
22	kPa	0.0001333220	7500.636259
23	Pa	0.1333220	7.500636259
24	Dy/cm <sup>2</sup>	1.333220	0.750063626
25	g/cm <sup>2</sup>	0.001359506	735.561166
26	kg/cm <sup>2</sup>	0.000001359506	735561.166
27	MSW 0°C 3.5% salinity	0.00001322347	75623.11663
28	OSI	0.0003093875	3232.1992
29	PSF	0.002784488	359.132477
30	TSF	0.000001392244	718265.0575
32	μHg 0°C	1.0	1.000000022
33	TSI	n/a	n/a
35	hPa	0.001333220	750.0636259
36	MPa	0.0000001333220	7500636.259
37	mmH <sub>2</sub> O 20°C	0.01361955	73.42388114
38	cmH <sub>2</sub> O 20°C	0.001361955	734.2388114
39	mH <sub>2</sub> O 20°C	0.00001361955	73423.88114

## Conversion Factors, Pascal

The following table lists factors which should be used as multipliers when converting other pressure units to or from Pascal.

Code	Pressure Unit	To convert from Pascal	To convert to Pascal
1	PSI	1.450377E-04	6.894757E+03
2	inHg 0°C	2.952997E-04	3.386390E+03
3	inHg 60°F	2.961339E-04	3.376850E+03
4	inH <sub>2</sub> O 4°C	4.014741E-03	2.490820E+02
5	inH <sub>2</sub> O 20°C	4.021862E-03	2.486410E+02
6	inH <sub>2</sub> O 60°F	4.018645E-03	2.488400E+02
7	ftH <sub>2</sub> O 4°C	3.345622E-04	2.988980E+03
8	ftH <sub>2</sub> O 20°C	3.351551E-04	2.983692E+03
9	ftH <sub>2</sub> O 60°F	3.348871E-04	2.986080E+03
10	mTorr	7.500636E+00	1.333220E-01
11	inSW 0°C 3.5% sal	3.904899E-03	2.560885E+02
12	ftSW 0°C 3.5% sal	3.254082E-04	3.073062E+03
13	ATM	9.869230E-06	1.013250E+05
14	bar	1.00000E-05	1.00000E+05
15	mbar	1.00000E-02	1.00000E+02
16	mmH <sub>2</sub> O 4°C	1.019744E-01	9.806378E+00
17	cmH <sub>2</sub> O 4°C	1.019744E-02	9.806378E+01
18	mH <sub>2</sub> O 4°C	1.019744E-04	9.806378E+03
19	mmHg 0°C	7.500636E-03	1.333220E+02
20	cmHg 0°C	7.500636E-04	1.333220E+03
21	torr	7.500636E-03	1.333220E+02
22	kPa	1.00000E-03	1.00000E+03
23	Pa	1.00000E+00	1.00000E+00
24	Dy/cm <sup>2</sup>	1.00000E+01	1.00000E-01
25	g/cm <sup>2</sup>	1.019716E-02	9.806647E+01
26	kg/cm <sup>2</sup>	1.019716E-05	9.806647E+04
27	MSW 0°C 3.5% sal	9.918444E-05	1.008222E+04
28	OSI	2.320603E-03	4.309223E+02
29	PSF	2.088543E-02	4.788025E+01
30	TSF	1.044271E-05	9.576052E+04
32	μHg 0°C	7.500636E+00	1.333220E-01
33	TSI	7.251885E-08	1.378951E+07
35	hPa	1.00000E-02	1.00000E+02
36	MPa	1.00000E-06	1.00000E+06
37	mmH <sub>2</sub> O 20°C	1.021553E-01	9.789017E+00
38	cmH <sub>2</sub> O 20°C	1.021553E-02	9.789017E+01
39	mH <sub>2</sub> O 20°C	1.021553E-04	9.789017E+03

## Installing POC8 to MCS200 Module Rack

These instructions apply only if you have bought POC8 and a MCS200 Bench system separately and want to install POC8 into MCS200's Module Rack.



**Warning**

**Before opening MCS200's Module Rack and working inside it, ensure all electrical power as well as pressure supplies are off.**

Ensure that you have a Bench Mounting Kit available. It includes the following items:

- Front panel plate with a hole for POC8 and a connector for pressure control/measurement,
- installation plate to be fixed inside the Module Rack,
- two clamps to fix POC8 to the installation plate and
- a set of bolts, nuts and washers.

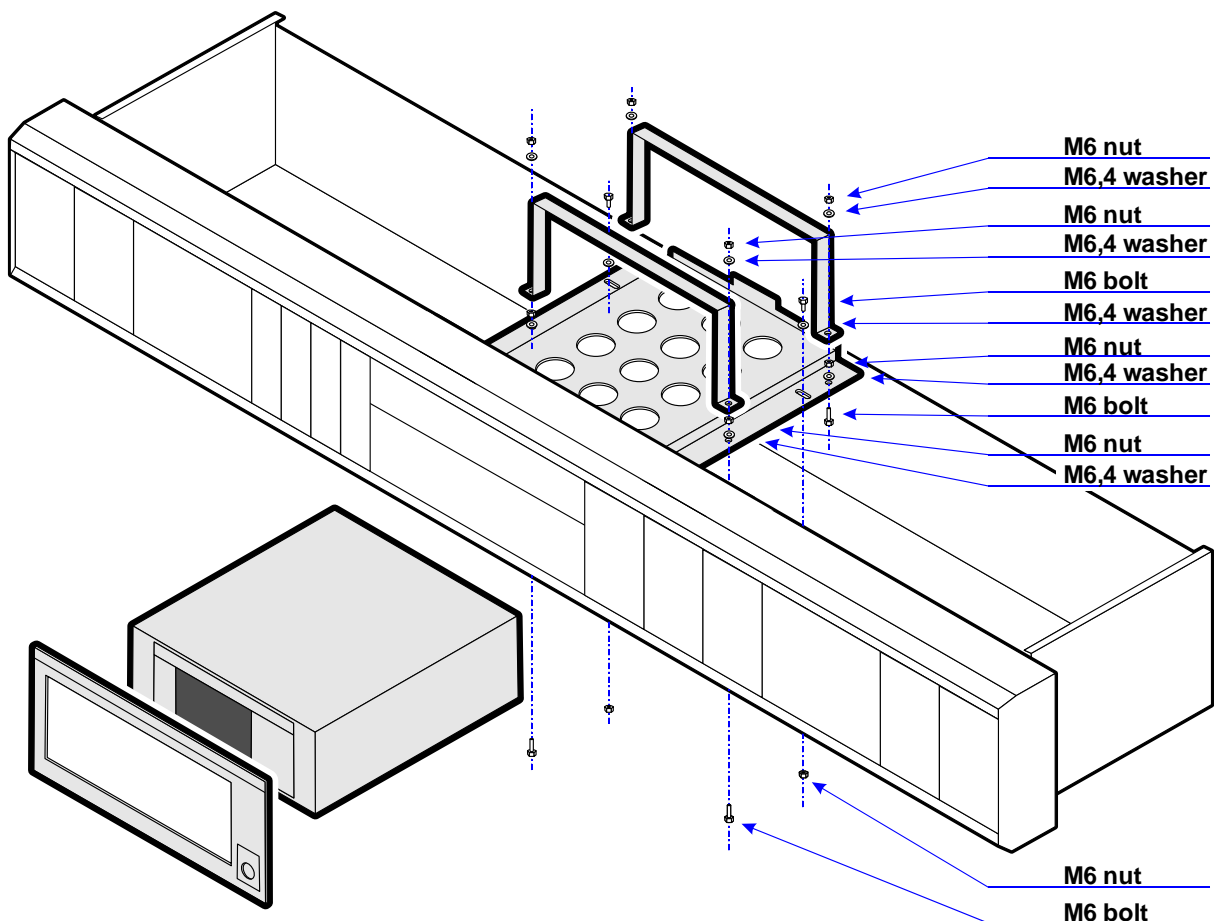

*Installing POC8 into an MCS200's Module Rack.*

## Installation Procedure

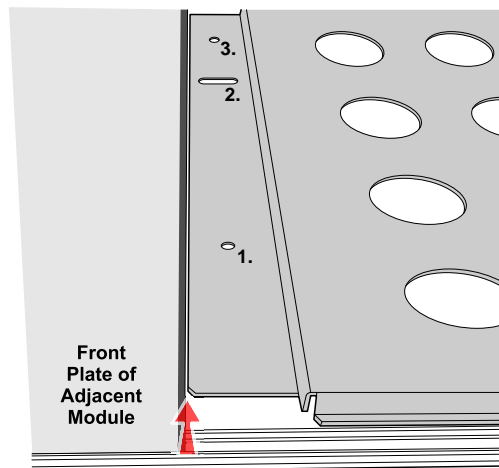

*Placement of installation plate.*

- Align the installation plate inside the module rack as presented in the picture above (red arrow).
- Start fixing the plate from the oval holes (marked with **2.** in the picture above). Locate corresponding square holes in the bottom of the module rack.
- Drill 7 mm holes in the module rack, using the holes marked with **1.** as guides. Fix the installation plate from the holes. Push the bolts from the bottom of the module rack. See picture below.
- Push a bolt from the bottom at holes marked **3.** in the pictures above and below and fix it

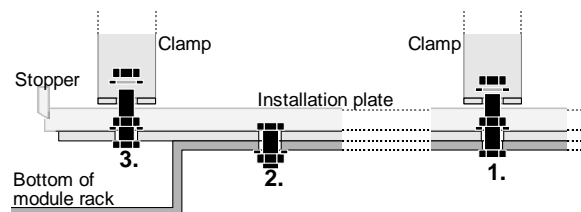

*Fixing the installation plate.*

- Place POC8 on the installation plate and push POC8 into the module rack until POC8 meets the stopper at the back of installation plate.
- Fix the front panel plate to MCS200.
- Fix POC8 using the clamps as shown in the picture above.

## Connections

After POC8 is installed into MCS200's module rack, do the connections as shown in the picture below.

