

MC6-WS

Advanced Workshop Calibrator and Communicator



Applies to firmware version 3.2

Dear user,

We have made every effort to ensure the accuracy of the contents of this manual. Should any errors be detected, we would greatly appreciate to receive suggestions to improve the quality of the contents of this manual.

For more detailed technical data about Beamex MC6 Advanced Workshop Calibrator and Communicator, please contact the manufacturer.

© Beamex 2023

Beamex Oy Ab

Ristisuonraitti 10

FIN-68600 Pietarsaari

Finland

Tel: +358-10-5505000

E-mail: sales@beamex.com

service@beamex.com

Website: <https://www.beamex.com>

Table of Contents

Feedback.....	6
Part 1, Introduction.....	7
General.....	7
About This Manual.....	7
Where am I?.....	8
Typographical Conventions.....	8
Unpacking and Inspection.....	8
About MC6-WS.....	9
Starting MC6-WS.....	9
Firmware.....	10
Hardware.....	14
General.....	14
Pressure Modules.....	15
Front Panel Connection Details.....	16
Connectors At The Back of MC6-WS.....	17
Memory.....	18
Display.....	18
Batteries.....	19
PC Communication/Calibration software.....	19
USB Communication Driver.....	20
MC6-WS Related Tools Available for PC.....	20
Options.....	20
Software Options.....	20
Hardware Modules/Options and Accessories.....	21
Related Products.....	22
Part 2, Active Terminals and Connections.....	23
General.....	23
Measurements.....	24
Pressure Measurement.....	24
Connecting and Disconnecting External Pressure Modules... 24	
Zeroing a Pressure Module.....	25
Current Measurement.....	25
Voltage Measurement.....	26
Temperature Measurement (Thermocouple).....	27
Temperature Measurement (RTD).....	27
Resistance Measurement.....	28
Frequency Measurement.....	29
Pulse Counting.....	29
Switch Sensing.....	30
Generations/Simulations.....	31
Changing the Generated/Simulated Value.....	31

Using the Soft Numeric Keypad.....	31
Spinning.....	32
Current Generation (Source or Sink).....	33
Voltage Generation.....	34
Thermocouple Simulation.....	34
RTD Sensor Simulation.....	35
Resistance Simulation.....	36
Frequency Generation.....	37
Pulse Generation.....	37
Thermocouple Connections.....	38
Part 3, Meter.....	40
About Meter.....	40
Part 4, Calibrator.....	42
About Calibrator.....	42
Tools.....	43
General.....	43
Part 5, Documenting Calibrator.....	47
General.....	47
Calibration Software.....	48
Calibrating Instruments.....	48
Generating/Simulating the Input Value.....	49
Instrument List.....	49
Instruments.....	50
Plant Structure Levels.....	51
Instrument List Window Menu.....	52
Instrument Overview Window.....	53
Calibrating an Instrument Using MC6-WS.....	54
Changing the Pressure Module During Calibration.....	58
About Fieldbus and HART Device Specifics.....	58
Group Calibration.....	60
Collecting Instruments/Functions for Group Calibration.....	60
Editing a Group.....	62
Calibrating a Group.....	63
Group Settings.....	63
Performing the Calibration.....	64
Calibration Results.....	65
Deleting Calibration Results.....	66
Digital Communication and MC6-WS's Instrument Data.....	66
Getting and Editing Mapped Data.....	67
Preparations.....	67
Getting Default Mappings.....	67
Customizing the Mappings.....	68
Part 6, Data Logger.....	72
General.....	72

Doing a Data Log.....	73
Configuring.....	73
Saving and Opening Configurations.....	74
Starting the Data Log.....	75
Viewing and Saving or Deleting the Results.....	76
Viewing Saved Data Log Results.....	77
Transferring Data Log Results to a Personal Computer.....	78
Part 7, Communicator.....	80
General.....	80
Warnings.....	82
Connections.....	83
Selecting the Instrument.....	84
List of Found Devices.....	84
About Instrument Parameters.....	86
Instrument Parameters in General.....	86
Calibrating or Data Logging HART Instruments.....	87
Calibrating or Data Logging Fieldbus Instruments.....	88
Editing Parameters.....	88
Trimming a Fieldbus Instrument.....	89
Trimming a HART Instrument.....	91
HART Device Description Specifics.....	93
General.....	93
Basic View.....	95
Managing Smart Transmitter Configurations.....	96
General.....	96
Tools in MC6-WS.....	97
Saving Configurations.....	97
Viewing/Managing Configurations.....	97
Beamex MC6 Fieldbus Configuration Viewer.....	98
Uploading Configurations.....	99
Linking Configurations to CMX.....	99
Part 8, Settings.....	100
Settings.....	100
Optional Security Tool.....	101
General.....	101
Applied Restrictions.....	101
Part 9, Additional Information.....	103
Additional Information.....	103
User Defined Pressure Units.....	104
User Defined PRT/RTD Sensors.....	105
General.....	105
Callendar van Dusen Formula for PRTs.....	107
ITS-90 PRT Sensor.....	108
Factor.....	110
Check Sensor Conversion.....	111

User Defined Transfer Functions.....	112
User Defined Steps/Calibration Points.....	114
Controller Communication.....	115
What Can be Done With Controller Communication.....	115
Configuring Controller Communication.....	117
Changing Controller During Calibration.....	118
Appendix.....	119
Safety.....	119
Approvals.....	119
Symbols Used.....	119
Safety Precautions and Warnings.....	120
Operating Conditions.....	120
General Warnings.....	120
Warnings Concerning the Lithium Polymer Battery Pack....	121
Disposal/Replacement of Battery Pack.....	121
Charging the Lithium Polymer Battery Pack.....	122
Storing.....	123
Warnings Concerning Electrical Measurement and Generation.....	123
General Warnings Concerning Pressure Measurement.....	124
Warnings Concerning High Pressure.....	125
Disposal of Waste Electrical and Electronic Equipment.....	126
Beamex and WEEE.....	126
Disposal of Battery Pack.....	126
Service.....	127
Cleaning MC6-WS.....	127
The Battery Charger.....	127
Sending MC6-WS for Service.....	127
Firmware Update.....	128
Resetting MC6-WS.....	129
Recalibrating MC6-WS.....	129
Uninstalling/installing Modules to/from CENTRICAL.....	130
MC6-WS's Battery Pack And Charger.....	130
Removing/Replacing the MC6-WS Battery Pack.....	130
Index.....	132

Feedback

We want to improve our products and services constantly. Therefore we'd like to know Your opinion of the product You use. Please spend a moment of Your valuable time by giving us feedback about the product.

Address: **Beamex Oy Ab**

Quality Feedback

Ristisuonraitti 10

FIN-68600 Pietarsaari

FINLAND

E-mail: support@beamex.com

Fax: +358 - 10 - 5505404

Internet: <https://www.beamex.com>

Part 1, Introduction

Things discussed in this part:

- About this manual
- Briefly about MC6-WS's hardware and firmware
- Available software and hardware options

General

Thank you for buying Beamex MC6 Advanced Workshop Calibrator and Communicator. Because of its versatile features, it really is "more than a calibrator".

MC6-WS is one device with five different operational modes: Meter, Calibrator, Documenting Calibrator, Data Logger and Fieldbus Communicator.



Note: Before taking MC6-WS into use, please read the warnings available in Appendix.

About This Manual

MC6-WS User Manual is divided into several parts as follows:

- [Part 1, Introduction](#) discusses general matters.
- [Part 2, Active Terminals and Connections](#). Whatever you measure, generate or simulate, here's how to make the necessary connections.
- [Part 3, Meter](#) introduces the metering tool, which is handy for making quick measurements. One measurement at a time.
- [Part 4, Calibrator](#). A more versatile tool which allows you to measure/generate/simulate two things simultaneously etc.
- [Part 5, Documenting Calibrator](#) concentrates on instrument calibration using the full featured documenting calibrator.
- [Part 6, Data Logger](#). Collecting and reviewing data and transferring logged data to a PC.
- [Part 7, Communicator](#). Invoking digital communication with modern instruments.
- [Part 8, Settings](#). How to customize MC6-WS and what the **About** window contains.
- [Part 9, Additional Information](#). About advanced tools for, e.g. adding custom pressure units, connecting external devices etc.

Where am I?

The header of each spread in MC6-WS User Manual informs you of where you are: The even page shows the part you are in and the odd page shows the main topic you are currently viewing.

Example of even page header:

2 – Part 1, Introduction

Example of odd page header:

About This Manual – 3

Typographical Conventions

The following typographical conventions apply to MC6-WS User Manual:

Bold text is used in following situations:

- References to User Manual topics and parts,
- MC6-WS keywords, i.e. terms shown in the User Interface and
- other keywords, e.g. the names of fieldbus parameters.



Note: This is a note. Notes typically inform you of something useful concerning the current topic.



Caution: This is a caution. Whenever you see a caution, read it carefully and take it seriously. By not observing cautions, you may damage the calibrator.



Warning: This is a warning. Whenever you see a warning, read it carefully and take it seriously. By not observing warnings, you may -at worst- damage the calibrator and/or even risk your life.

Unpacking and Inspection

At the factory each new MC6-WS passes a careful inspection. It should be free of scrapes and scratches and in proper operation order upon receipt. The receiver should, however, inspect the unit for any damage that may have occurred during transit. If there are signs of obvious mechanical damage, package contents are incomplete, or MC6-WS does not operate according to specifications, contact the purchasing sales office as soon as possible.

If you have to return the instrument to the factory for any reason, use the original packing whenever possible. Include a detailed description of the reason for the return. Read also chapter [Sending MC6-WS for Service](#) in [Appendix](#).

For a description of available options, see [Options](#).

Standard accessories:

- Accredited calibration certificate,
- this User Manual,
- Warranty Card,
- test leads and clips,
- USB cable.

About MC6-WS

Starting MC6-WS

To start MC6-WS, switch the CENTRiCAL on. The MC6-WS will start automatically. To switch on just the MC6-WS, press and hold the **Power** button for a few seconds. The startup procedure ends in **Home View**. From MC6-WS's **Home View** you may advance to any of the available main functions. This manual contains detailed information of main functions as follows:

- [Meter](#) in Part 3,
- [Calibrator](#) in Part 4,
- [Documenting Calibrator](#) in Part 5,
- [Data Logger](#) in Part 6,
- [Communicator](#) in Part 7 and
- [Settings](#) in Part 8.

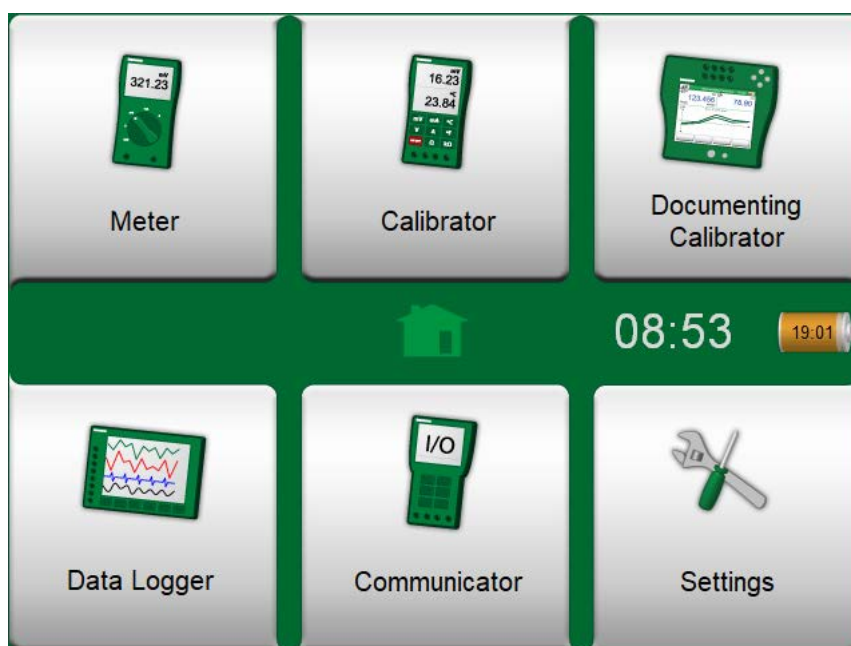

Figure 1: Home view



Figure 2: Power button (left) and Home button (right)

With the **Home** button (see [Figure 2: Power button \(left\) and Home button \(right\)](#)) you can always return to **Home View** from wherever you are.

When MC6-WS is already running, pressing the **Power** button briefly opens a dialog with the following options:

- **Power Off** to shut down MC6-WS in **Backup Mode**, i.e. minimum power consumption and full startup procedure.
- **Standby** to set MC6-WS in **Standby Mode** allowing faster startup when the **Power** button is pressed again.
- **Backlight Off** to temporarily set the backlight off.

The button on the right side of the dialog:

- **Power Management** to define Backlight Brightness and other power management related settings. More in [Part 8, Settings](#).

MC6-WS will shut down immediately when the bench's Main switch is switched off. The Battery Charging status window will not be displayed. MC6-WS can still be operated normally on battery power, when the bench's Main switch is switched off.



Note: Certain main functions are options. They may not be available in your MC6-WS. More of this in chapter [Options](#).

Firmware

You can interact with MC6-WS by tapping on available buttons/controls displayed on the touch screen. Optionally: use the hardware arrow keys to move between the available buttons/controls. The first time you push a hardware arrow key the **Hardware Focus Indicator** is displayed (a blue border around the active button/control). When using the hardware arrow keys, use the hardware Enter key to select ("tap") a button/control.



Figure 3: Button without and with a Hardware Focus Indicator

Buttons often open a pop-up window for entering data, e.g. a unit button with the text "mmH₂O" opens a pop-up window of available units. Certain buttons do have special functionality, like **"Accept"** and **"Close"** buttons. They close

a pop-up window and either accept or reject the changes. There are other buttons, e.g. for going to the next/previous page pages, scrolling through a wide table of data, removing a number in a numeric field (backspace), clearing a numeric field, etc. Most of them are familiar since they look similar as in personal computer software.



Figure 4: Accept button (left) and Close button (right)

One important button is the **Menu** button which is available in the upper left corner of almost any window. Tap on it to open a context-sensitive menu with, among other things,



Figure 5: Menu button (on the left)

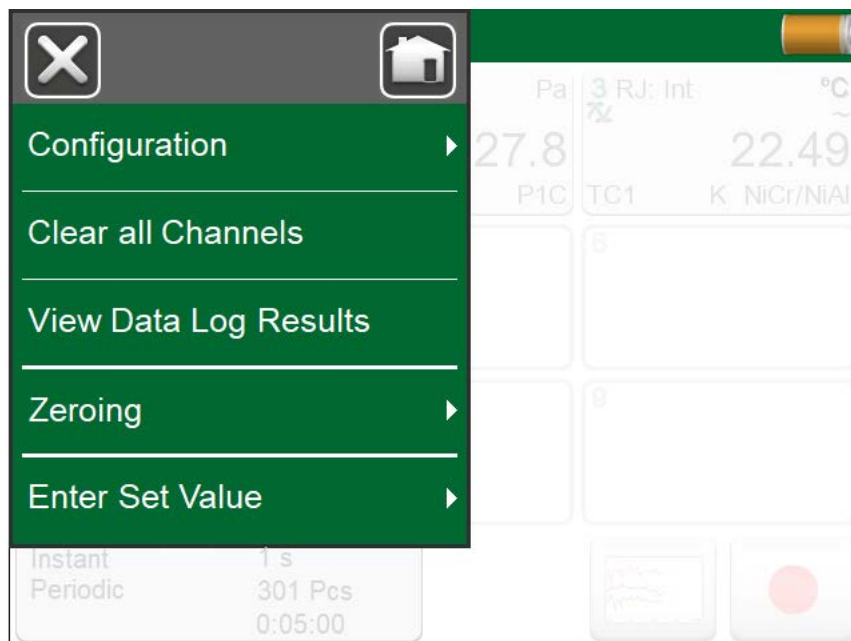

Figure 6: An example of an opened menu

Check Boxes are special buttons that are either "checked" or "unchecked". See [Figure 7: Check Boxes, both a checked and an unchecked one](#). Again, the functionality is familiar from personal computers.



Figure 7: Check Boxes, both a checked and an unchecked one

MC6-WS also has some "flat" buttons. They are used in, e.g. lists. The color of the flat buttons may vary depending on the context.

The following editable fields are available:

- **Text Fields,**
- **Numeric Fields,** in certain cases including **Spinning** and
- **Date/Time Fields.**

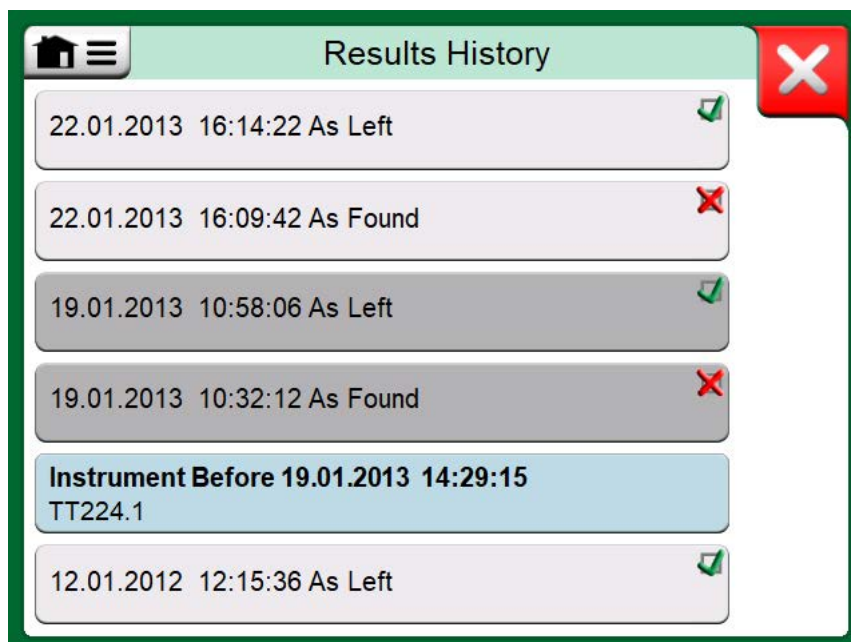

Figure 8: Example of a list with flat buttons

The letters/numbers on all editable fields are blue to indicate that they are editable. Black texts are descriptive user interface texts that are not editable. An example of a Text Field and the Text Edit Window are shown in [Figure 9: Text Field](#) and [Figure 10: Text Edit window](#).

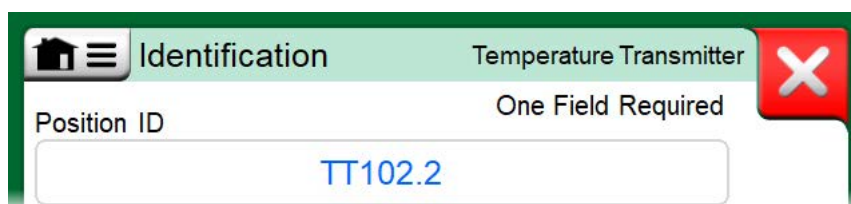

Figure 9: Text Field

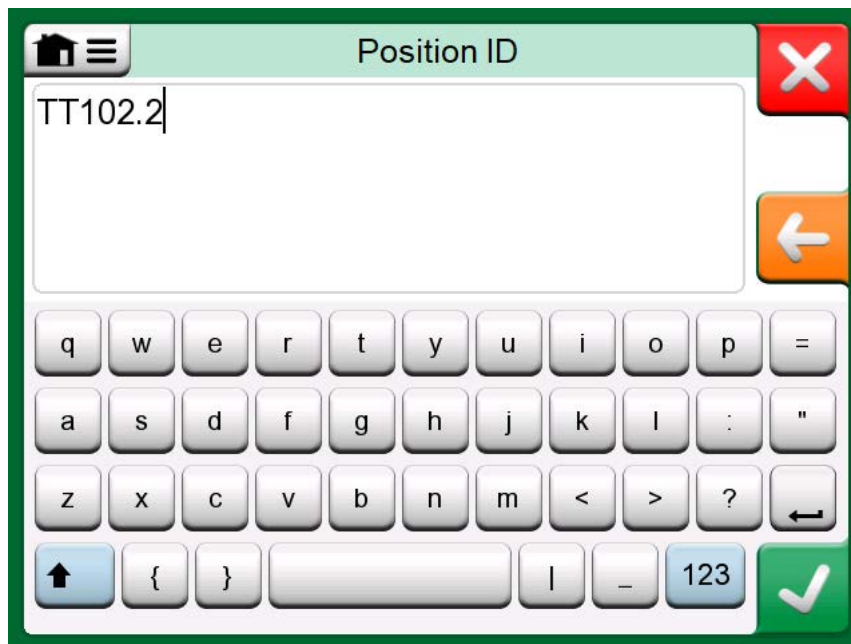

Figure 10: Text Edit window

Use of Numeric Fields and Spinning is described in [Part 2, Active Terminals and Connections](#) and [Part 5, Documenting Calibrator](#).

Date Fields are actually special cases of Numeric Fields. Entering the date is just like entering any numeric value.

Setting MC6-WS's time is a special case of the Spinning functionality. The "**Left**" and "**Right**" arrow buttons move the highlight to another digit. The "**Up**" and "**Down**" arrow buttons change the value of the highlighted digit.

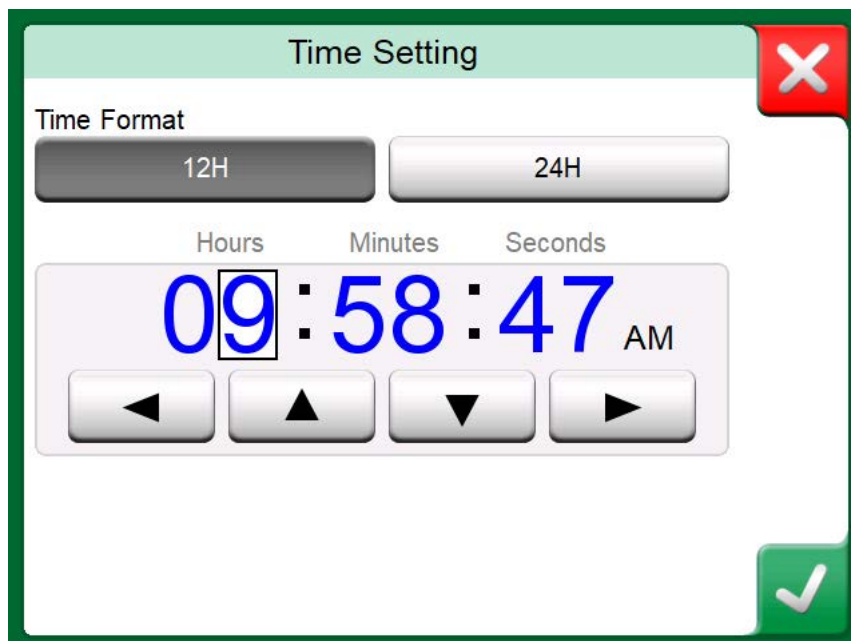

Figure 11: Time Setting window

Hardware

General

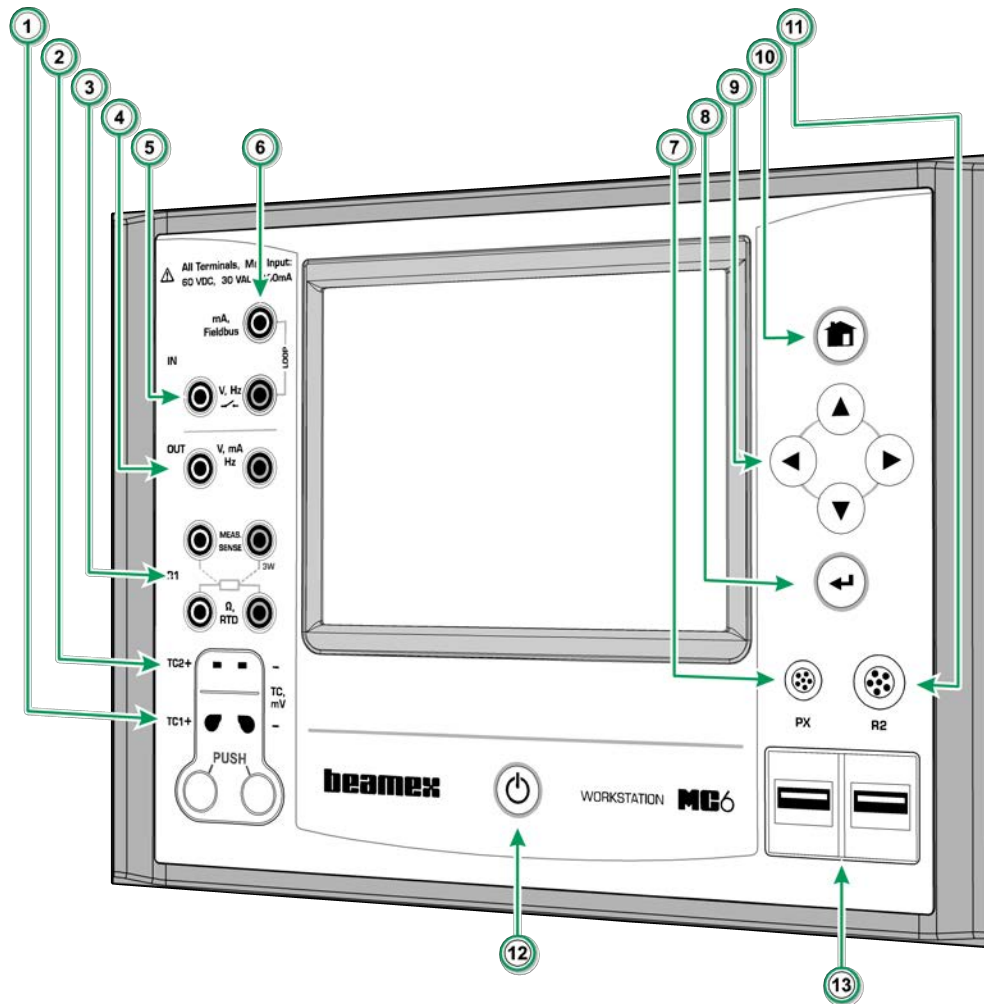

Figure 12: MC6-WS, front view

Legend:

1. **Thermocouple** connector (**TC1**) with release buttons. For cables and standard TC plugs.
2. **Thermocouple** connector (**TC2**). For TC plugs with flat contacts.
3. **RTD** and **Resistor** connector (**R1**). An **R2** connector is on the top of MC6-WS.
4. **Voltage, Current and Frequency** output (**OUT**).
5. **Voltage, Frequency and Switch** input (**IN**).
6. **Current Measurement, Loop Supply, HART[®]** and **Fieldbus** connection (**IN**).
7. Connector for **External Pressure Modules (PX)**.

8. **Enter** button for selecting the item surrounded with the **Hardware Focus Indicator**.
9. **Arrow** buttons. First press displays the **Hardware Focus Indicator**. Further presses move the indicator on the touch screen.
10. **Home** button. Press this button to return to **Home View**.
11. **R2** connector. A possibility to connect an external RTD sensor to MC6-WS. See also [Hardware Modules/Options and Accessories](#).
12. **Power** button, see chapter [Starting MC6-WS](#).
13. Two **USB-A** connectors for connecting USB devices to MC6-WS. See also chapter [Firmware Update](#).

Pressure Modules

MC6-WS supports up to ten pressure modules plus a barometric module connected to it via a daisy chain communication cable inside the CENTRiCAL. The amount of modules varies depending on the system at hand. MC6-WS User Interface refers to Pressure Modules as **PX: P1C**.

Where:

- **X** is the ID address of a pressure module (0 to 9)
- P1C etc. are the pressure module types

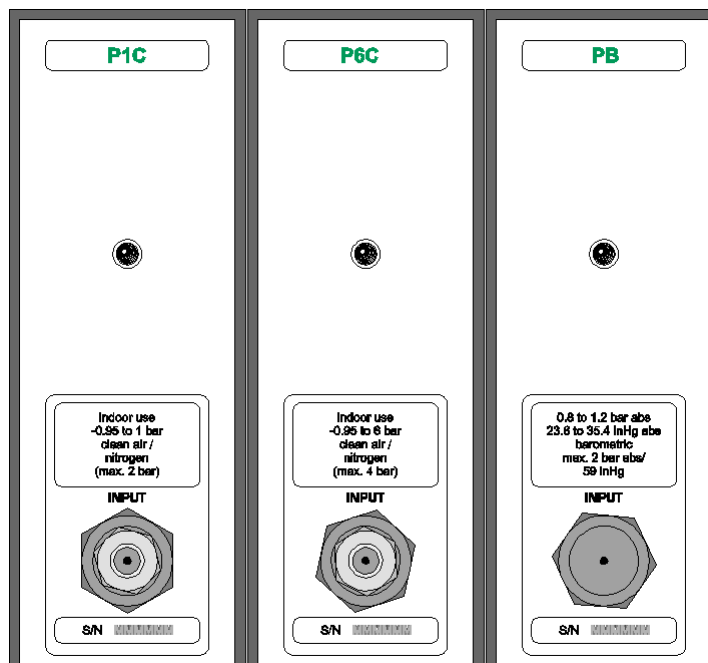

Figure 13: Example of set of Pressure Modules in CENTRiCAL

The recommended pressure medium for pressure modules is clean air. Clean non-corrosive liquids may optionally be used in modules with a measuring range of 20 bar/300 psi or more. Avoid spilling liquid on MC6-WS when connecting/disconnecting pressure hoses to/from pressure modules.

To avoid damaging the module, use hand tightening only when connecting the pressure measurement hoses (max. torque 5 Nm, approx. 3.6 lbf ft). If the use of tools is required to secure the connection (typically pressure modules with a pressure range higher than 20 bar), apply the counterforce by placing a 14 mm (approx. 9/16") A/F spanner on the flats found in the module's connector. The overpressure protection of the internal pressure modules vents to the inside of the module rack.

Barometric Module

Barometric Modules are shown as **PB: PB** in the MC6-WS's User Interface. The connection in front of a Barometric Module is meant for calibration use. The thread is M5. To ensure valid barometric pressure measurements, do not use the connection unless calibrating the module.

See [Appendix](#) for information on installing and uninstalling Pressure Modules.



Note: Remember to be cautious when working with pressure and pressure modules. See also chapter [Safety Precautions and Warnings](#).

Front Panel Connection Details

If you use other pressure hoses than the one delivered by Beamex, remove the connector meant for Beamex's pressure hoses and replace them with your own connectors. The thread available in a Pressure Module's body is 1/8" BSP.

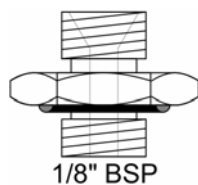

Figure 14: Pressure module connector's thread

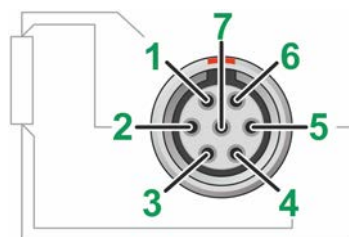

Figure 15: Outside view of the female connector in MC6-WS

R2 connector's pin order:

1. Excitation current +
2. Sense +
3. Not in use
4. Sense -

5. Excitation current -



Note: Leave pins 3, 6 and 7 unconnected in the male connector meant for MC6-WS's R2 connector.

Connectors At The Back of MC6-WS

The rear end of MC6-WS (inside CENTRiCAL Instrument Panel) includes the same connectors as in a portable MC6. There's also a Pressure Module connector for connecting Pressure modules in CENTRiCAL.

USB Ports

The need for USB connectors in MC6-WS may be more than is available in a portable MC6. That is why there is an isolated hub included with MC6-WS inside CENTRiCAL Instrument Panel. Two of the hub's ports are connected to the USB-A ports in MC6-WS's front panel allowing communication with, e.g. Dry Blocks.

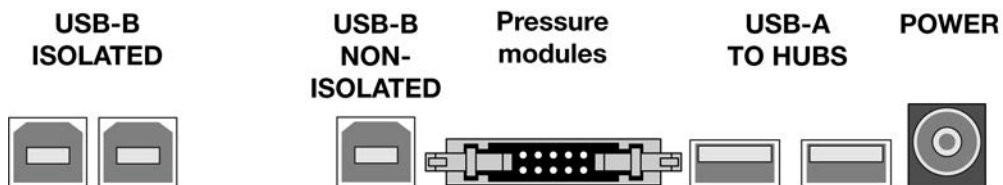

Figure 16: Rear view of MC6-WS (inside CENTRiCAL)

A USB-B connector in MC6-WS is connected to USB PC - MC6 connector located in equipment Panel in the Function Board (under the Flaps).

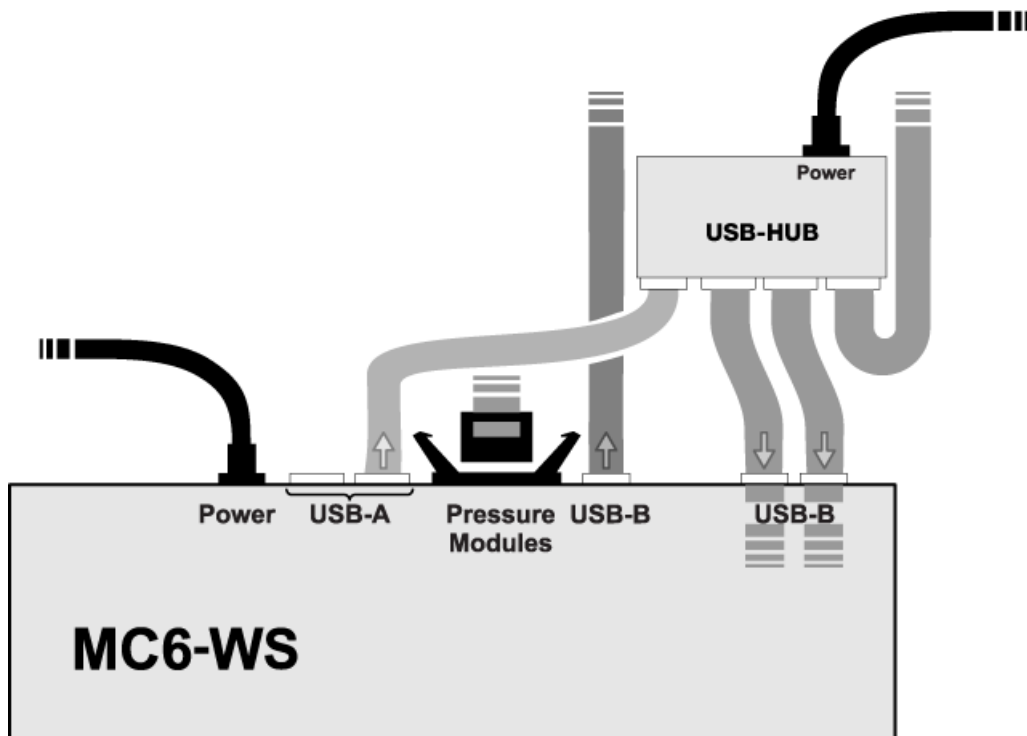

Figure 17: Default connections inside CENTRiCAL. Top view of MC6-WS



Note: All USB connectors are USB 2.0 Full Speed ports.

Memory

MC6-WS maintains data very much like personal computers. Data is saved on a solid state memory that does not need any power to maintain its state. Solid state memory is shock-proof so the data is not lost when the calibrator is transported. Also, you can safely save a large amount of instruments, calibration results and data log results.

Available memory can be used for anything that requires it (e.g. instrument data, calibration results etc.).

Display

MC6-WS has a backlit 640 × 480 pixel 5.7" TFT touch screen display. Use the touch screen with your fingers, gloves on or off. Optionally, use a stylus meant for touch screen use.

See also brightness settings in [Part 8, Settings](#).



Warning: Using sharp tools such as a screwdriver on the touch screen may damage it. More warnings in [Appendix](#).

Batteries

MC6-WS has internal rechargeable Lithium Polymer (LiPo) batteries for powering the internal clock when CENTRiCAL is shut off. The charger is connected to CENTRiCAL's power supply so the battery is automatically charged when the CENTRiCAL is on. LiPo batteries do not suffer from the memory effect, so they may be charged at any time. However, there are some serious safety issues concerning them, so read [Warnings Concerning the Lithium Polymer Battery Pack](#) in [Appendix](#).

A picture of a battery (or a plug, when charging or running on AC power) is shown on many of MC6-WS views. The "content" of the battery corresponds to the approximated charge level of MC6-WS rechargeable batteries.

The maximum operating time of the batteries without recharging varies depending on the usage of the display back light. The usage of the 24 V transmitter supply also affects the maximum operating time. Even with constant maximum load, the standard rechargeable batteries should last for 10 hours. A good average operating time is 16 hours.

The capacity of all batteries deteriorate with time. If MC6-WS internal clock is reset, it is time to replace the battery pack with a new one. See [Appendix](#) for information on how to replace the Battery pack.



Figure 18: Full battery - empty battery



Note: A time approximate (hh:mm) is shown on the battery symbol. During charging it is the charging time left, otherwise it is remaining usage time.

MC6-WS internal clock/calendar uses a small amount of power even when CENTRiCAL/MC6-WS is switched off. Remember to check the capacity of the batteries from time to time although MC6-WS is not in use. Recharge if needed. Tap the battery icon to open a window displaying detailed battery/charging information.

PC Communication/Calibration software

Beamex CMX Calibration Management Software supports MC6-WS from version V2, revision 2.8 onwards and also in **Beamex LOGiCAL** Calibration Management Software.

UBS Communication Driver

MC6-WS uses Windows' generic USB driver (WinUSB) provided by Microsoft. Supported operating systems: Windows[®] 7 ... Windows[®] 10. Starting from Windows 8, the driver installation is self-contained, older versions may require Windows Update connection.

MC6-WS Related Tools Available for PC

The following tools are available for download at Beamex's website: <https://www.beamex.com>. Look for **Download Center** and **Software tools for MC6 family**.

- **Beamex MC6 Data Log Viewer**, for transferring Data Log results to a PC and viewing them on the PC.
- **Beamex MC6 Device Description Installer**, for installing new Device Descriptions of smart transmitters from a PC to MC6-WS.
- **Beamex MC6 Fieldbus Configuration Viewer**, for downloading smart transmitter configurations read into MC6-WS to a PC.
- **Beamex MC6 Remote Controller**, for controlling MC6-WS via a PC.

Options

Software Options

The following software options are available:

- **Mobile Security Plus**, a solution which ensures the integrity of calibration data throughout the Beamex ICS solution. This option is also required in the **CMX Calibration Management Software** version V2, revision 2.11 or later,
- Multichannel **Data Logger**,
- **Communicator**, HART[®],
- *) **Communicator**, FOUNDATION Fieldbus[™],
- *) **Communicator**, PROFIBUS PA[™],
- +) Drivers for **External Controllers** (Pressure and Temperature) and
- **Special Temperature Sensors**.



Note: The software options available in the MC6-WS at hand can be found in MC6-WS's **Settings** main function. Select **About** option and browse to page 3. Whether the communication hardware needed for fieldbus communication is installed or not, can be found in MC6-WS's **Settings** main function. Select **About** option and see page 1.

*) Requires that communicating hardware is installed into MC6-WS. Please contact Beamex.

+) When necessary, a connection cable is shipped when the software option is bought.

Hardware Modules/Options and Accessories

- **Pressure Modules.** Up to nine gauge and/or differential pressure modules may be installed in CENTRICAL's Instrument panel and additionally a barometric module.
- Communicating hardware for MC6-WS's **Communicator** software options. See also [Software Options](#).
- **Adapter cables** for R2 connector. The R2 connector supports **Beamex Smart Reference Probe**.
- **Cable** for Pressure and Temperature Controllers.
- **Spare Battery Pack.**
- **Pressure Hose Sets** to be used together with internal and external **Pressure Modules**.



Note: The Pressure Modules internally connected to the MC6-WS at hand can be found in MC6-WS's **Settings** main function. Select **About** option and browse to page 2.

Related Products

There are an increasing number of devices that can be used together with MC6-WS. The following list includes devices that are already available (valid when this manual was printed):

- **ePG** Electric Pressure Pump and Controller
- External Pressure Modules (EXT),
- Calibration hand pumps:
 - **PGV** vacuum pump,
 - **PGL** low pressure calibration pump,
 - **PGC** pressure/vacuum pump,
 - **PGM** high pressure pump,
 - **PGPH** high pressure pneumatic pump and
 - **PGHH** hydraulic high pressure pump.
- Beamex **POC8** Automatic Pressure Controller,
- Beamex Field Temperature Block (**FB** Series),
- Beamex Metrology Temperature Block (**MB** Series),
- Beamex **CMX** Calibration Management Software and
- Beamex **LOGiCAL** Calibration Management Software.

Part 2, Active Terminals and Connections

Things discussed in this part:

- A presentation of measurements MC6-WS is capable of performing. For all measurements, the active terminals together with useful additional information for that particular measurement are presented.
- Similarly, a presentation of generations and simulations MC6-WS is capable of performing.
- For generations/simulations, there is also information on how to change the generated/simulated value.

General

This section of MC6-WS User Manual presents all measurements and generations/simulations that MC6-WS is capable of performing. No matter which of the available main functions you use in MC6-WS, the connections presented here apply.

Settings in **Meter** and **Calibrator** are saved, so the next time you measure, generate or simulate something, the previous settings are available as defaults. (*

In **Calibrator** also the additional information row settings for all measurements/generations/simulations are saved for future needs. However damping, resolution and alarms are active for the current session only.



Note: For HART and Fieldbus instrument specifics, see [Part 7, Communicator](#). For information on External Devices (Pressure and Temperature Controllers) used together with Calibrator and Documenting Calibrator, see [Part 9, Additional Information](#).

In this manual, when presenting each measurement/generation/simulation there is a picture with highlighted active terminals. The highlight for possible optional connections is lighter. Connections to instruments are included if it requires special attention. See chapter [Current Generation \(Source or Sink\)](#).

*) When you use **Documenting Calibrator** and select an instrument for calibration, the instrument's settings (**Quantity, Port** etc.) are inherited to the **Calibrator**.

Respectively, when creating a new instrument in **Documenting Calibrator**, the settings in **Calibrator**'s subwindows are used as default settings for the new instrument's input and output.

Measurements

Pressure Measurement

MC6-WS supports the use of both pressure modules in CENTRiCAL, if installed, and the use of supported external pressure modules, when they are connected to MC6-WS.

Note that pressure measurement requires knowledge of **pressure types** (absolute pressure, gauge pressure and differential pressure). Measuring pressure with inadequate knowledge of pressure types and the dangers of pressure devices may result in false measurement results and/or serious accidents. **Please read the warnings in [Appendix](#).**



Figure 19: Example of pressure module connectors

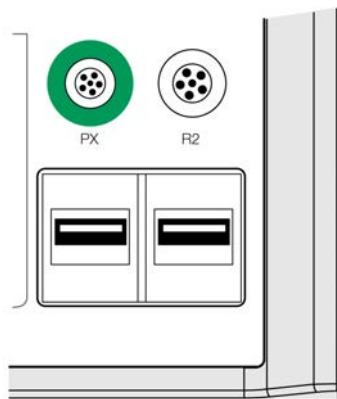

Figure 20: PX, Connector for external pressure measurement module in MC6-WS



Note: The amount of pressure modules in CENTRiCAL on your particular MC6-WS may differ from the picture presented here.

Connecting and Disconnecting External Pressure Modules

When an external pressure measurement module is connected and when applicable, MC6-WS opens a dialog. Among other information, the dialog

includes a possibility to choose where to use the connected external pressure module.

An external pressure module may be disconnected at any time. MC6-WS indicates that an external pressure module was removed. If the module was used for a measurement, the measurement stops.



Warning: Select a pressure module that has a suitable measurement range for your pressure signal. Too low/high measurement range on the pressure module results in faulty modules, imprecise readings or even accidents.

Zeroing a Pressure Module

If the selected pressure module does not display zero gauge pressure when the applied pressure is zero, the module has to be zeroed. To do it, apply zero gauge pressure and tap the zero button.



Current Measurement

When measuring electric current, an important thing is selecting whether MC6-WS provides the 24 volt **loop supply voltage** or not. If not, an external device should provide the loop supply voltage.

Connection depends on the loop supply setting.

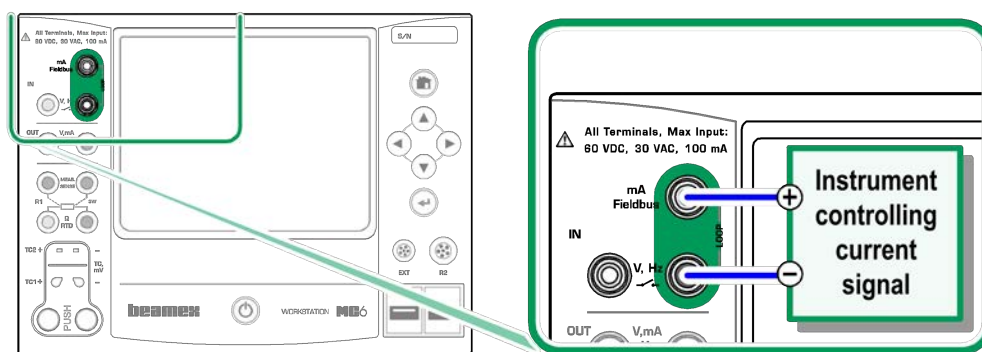

Figure 21: Current measurement terminals. Internal supply Range -101 ... +101 mA

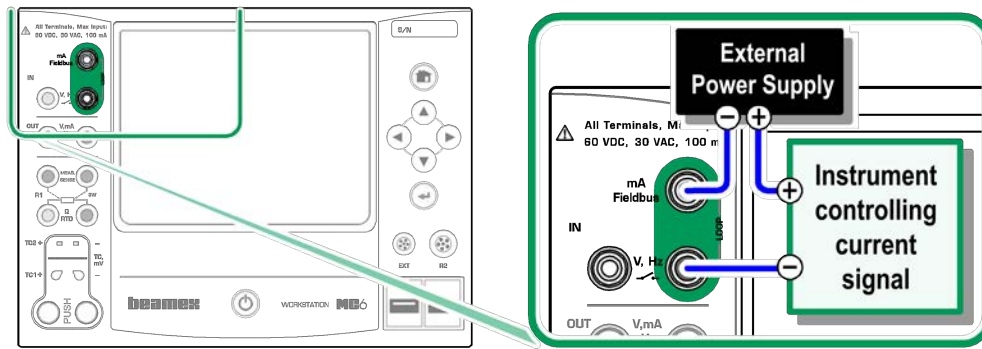

Figure 22: Current measurement terminals. External supply

See also chapter [Current Generation \(Source or Sink\)](#).

Voltage Measurement

MC6-WS's voltage measurement terminals are listed below (top to bottom) as they are shown in [Figure 23: Voltage measurement terminals](#) (left to right):

- **TC1**, measurement range: -1.01 to +1.01 VDC.
- **TC2**, measurement range: -1.01 to +1.01 VDC.
- **IN**, measurement range: -1.01 to +60.6 VDC.

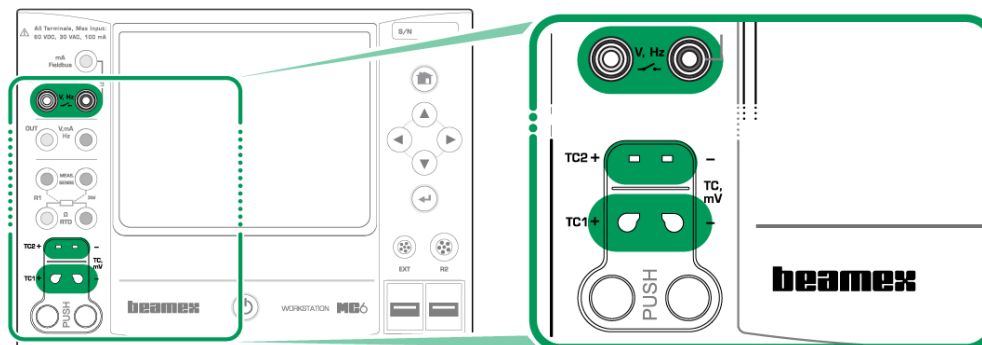

Figure 23: Voltage measurement terminals

Note that you may measure non-supported thermocouple signals using either **TC1** or **TC2** port. The reading is in (milli)volts, so you need a data table to convert the signal to temperatures. **Calibrator's** and **Documenting Calibrator's Scaling** utility may be used for converting millivolts to temperatures.



Warning: Do not apply hazardous voltages to MC6-WS's terminals.

See also chapters [Voltage Generation](#) and [Temperature Measurement \(Thermocouple\)](#).

Temperature Measurement (Thermocouple)

MC6-WS has two thermocouple connectors. **TC1** is for cables and standard TC plugs. **TC2** is for TC plugs with flat contacts.

Check the **Sensor Type**. Your measurement results are unreliable unless you select the same sensor type as is connected to MC6-WS. Select also a suitable **Reference Junction** compensation method. Wrong settings yield useless measurement results.

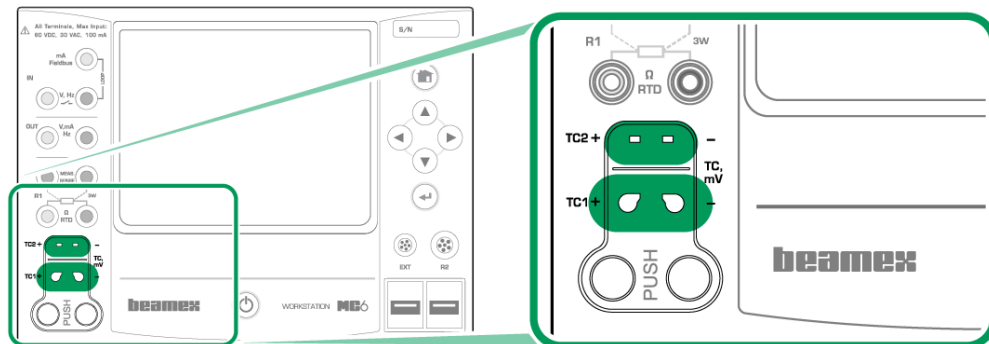

Figure 24: Thermocouple measurement terminals. Range depends on sensor type

See also chapters [Thermocouple Simulation](#) and [Voltage Measurement](#).



Warning: When using another thermocouple or an RTD sensor connected to MC6-WS to measure the external reference junction temperature: Keep in mind that there is no isolation between the thermocouple to be calibrated and the sensor measuring the reference temperature.



Note: Thermocouple measurements are error prone. There may be faulty connections, wrong (extension) cables and settings in MC6-WS. If unsure, see chapter [Thermocouple Connections](#) and study thermocouple literature.

Temperature Measurement (RTD)

Check the **sensor type**. Make sure you select the same sensor type as is connected to MC6-WS. Otherwise your measurement results are unreliable.

For R1 terminals:

The two leftmost terminals are used in 2-wire systems. MC6-WS automatically checks the connection and displays the found wiring system.

For R2 terminal:

Beamex offers, as an option, an adapter for the R2 terminal. Please contact Beamex for details. R2 terminal always uses 4-wire measurement.

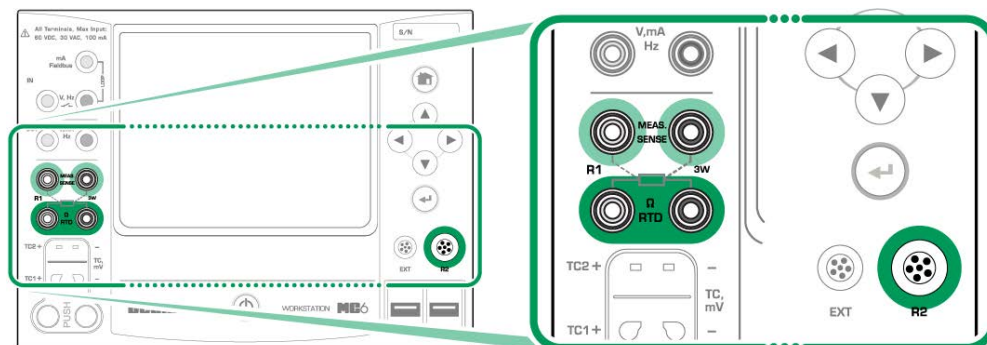

Figure 25: RTD measurement terminals. Range depends on sensor type

See also chapters [RTD Sensor Simulation](#), [Resistance Measurement](#) and [Resistance Simulation](#).



Note:

If you get "+OVER" or "-OVER" error messages, check the connections. If necessary, use 2-wire ohm measurement to check the wiring.

Resistance Measurement

For R1 terminals:

The two leftmost terminals are used in 2-wire systems. MC6-WS automatically checks the connection and displays the found wiring system (2-wire, 3-wire or 4-wire).

For R2 terminal:

Beamex offers, as an option, an adapter for the R2 terminal. Please contact Beamex for details. R2 terminal always uses 4-wire measurement.

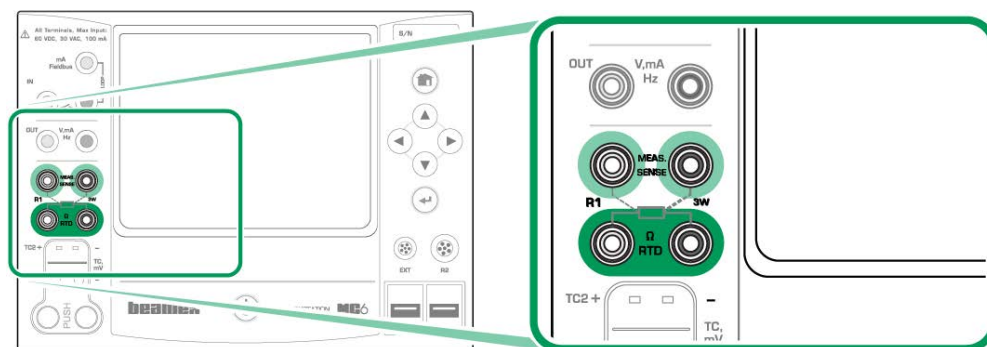

Figure 26: Resistance measurement terminals. Range -1 ... 4040 ohm

See also [Resistance Simulation](#) and [Temperature Measurement \(RTD\)](#).



Note: To ensure good contact between the device under test and the test leads, we recommend using the alligator clips provided with MC6-WS.

If you get "+OVER" or "-OVER" error messages, check the connections. If necessary, use 2-wire ohm measurement to check the wiring.

Frequency Measurement

In frequency measurement, be sure you select a suitable **trigger level** setting. To do it, tap on the button with the arrow pointing on a rising ramp and the current trigger level voltage. From the opened pop-up window: Select a suitable trigger level.

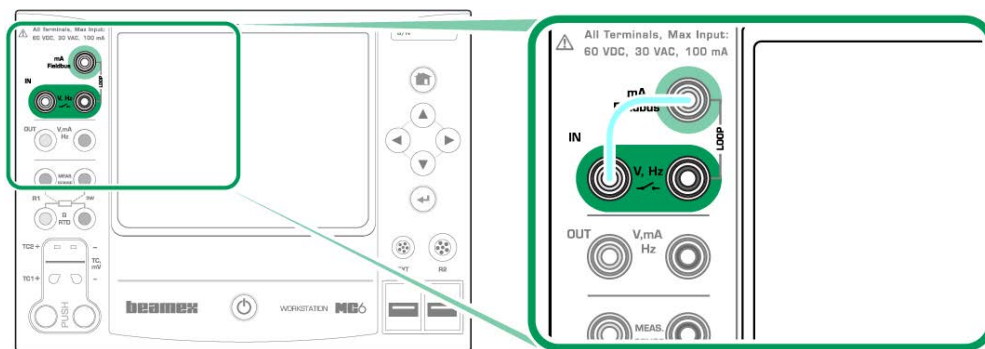

Figure 27: Frequency measurement terminals. Range 0.0027 ... 51000 Hz

See also [Frequency Generation](#), [Pulse Counting](#) and [Switch Sensing](#).



Note: There is a trigger level choice for (dry) contacts with no external potential. 24V supply may also be used. Connect as light blue line shows in picture above.

Pulse Counting

Pulse counting has three settings that should be checked before (re)starting a pulse count:

- **Trigger level.** Select a level that suits your signal.
- **Trigger edge.** Select either rising or falling edge.
- **Zeroing.** A possibility to zero the pulse count.

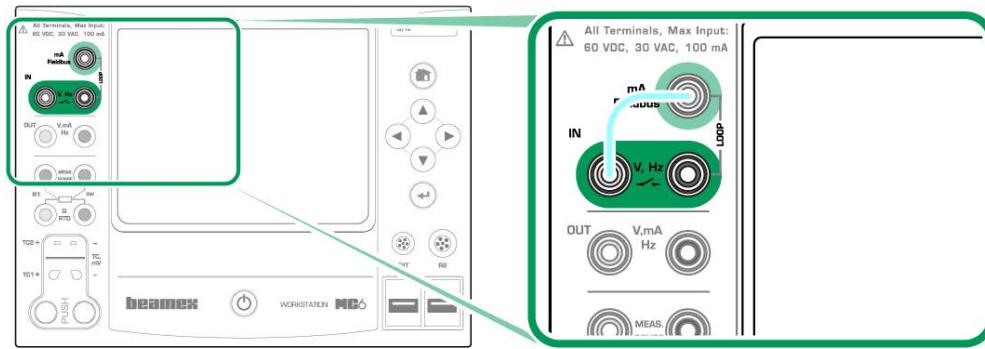

Figure 28: Pulse counting terminals. Range 0 ... 9 999 999 pulses

See also [Pulse Generation](#), [Frequency Generation](#) and [Frequency Measurement](#).



Note: There is a trigger level choice for (dry) contacts with no external potential. 24V supply may also be used. Connect as light blue line shows in picture above.

Switch Sensing

Switch Sensing has three settings:

- A possibility to **invert** switch's open/close state indication.
- **Trigger level**. Select a level that suits your switch. See note to the right.
- **Sound setting**. Define whether MC6-WS emits a sound when the switch's state change and if yes, when it is emitted.

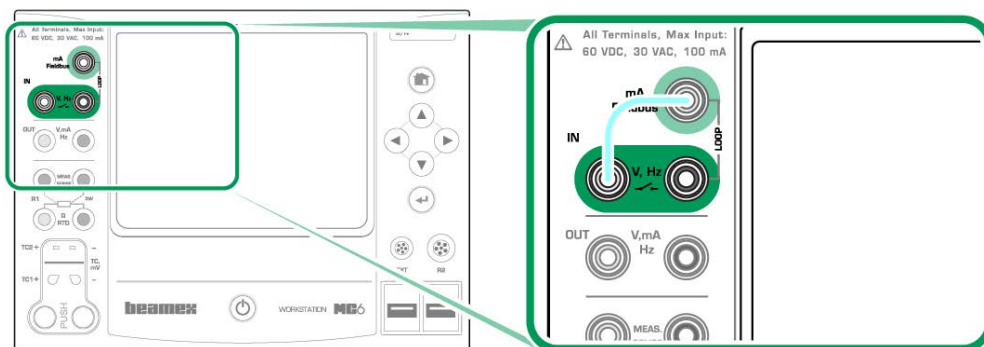

Figure 29: Switch sensing terminals

See also [Pulse Counting](#) and [Pulse Generation](#).



Note: There is a trigger level choice for (dry) contacts with no external potential. 24V supply may also be used. Connect as light blue line shows in picture above.

You can also use Switch Sensing for binary signal detection. For normal switch state detection: an open switch equals **1 / True** and a closed switch **0 / False**.

Generations/Simulations

Generations and simulations are supported in **Calibrator**, **Documenting Calibrator** and **Data Logger**.



Note: The **Meter** is not capable of performing generations and simulations.

Changing the Generated/Simulated Value

There are several ways of changing the generated/simulated value. The following subchapters present the available utilities.

Using the Soft Numeric Keypad

This utility is useful when a generated/simulated value (or any numeric field in MC6-WS) is either empty (displaying dashes) or when a new and different value is needed. The soft numeric keypad opens when you tap on the generated/simulated value (see [Figure 30: Soft Numeric Keypad](#)). Tap on numbers to enter a value. Additional functions:

- Use the "**C**" key on the right to clear the entered value.
- Use the "**Left Arrow**" key to delete the number to the left of the cursor.

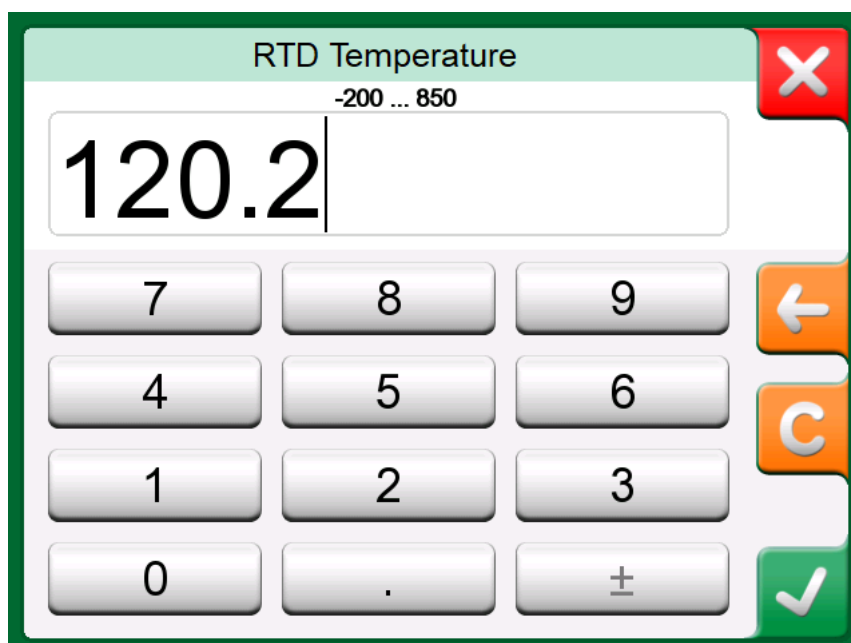

Figure 30: Soft Numeric Keypad

The entered value is taken into use when you close the window using the **"Accept"** button. Note that MC6-WS may use the entered value as a source for the value's resolution. Enter trailing zeros to ensure useful resolution.

When applicable, the minimum and maximum limit of the entered value is shown above the entered number. If you enter a value above/below the limits, and try to accept it, MC6-WS stays in the soft numeric keypad window and replaces the entered value with appropriate limit value and highlights the replaced value.

Spinning

Spinning is a tool that is available in **Calibrator** and **Documenting Calibrator**. It is useful when making small changes to an existing numeric value, one digit at a time.



Figure 31: Inactive spinner



Figure 32: Active spinner

Non-empty numeric fields in Calibrator's generation/simulation windows have a button with both "Up" and "Down" arrows to the left of the actual numeric value. That is the **Spinner** button. Tap the **Spinner** button to activate spinning.

When spinning is active, one of the digits is highlighted. Change its value by tapping the **"Up"** and **"Down"** arrows in the active spinner. To move the highlight to another digit, use the **"Left"** and **"Right"** arrows.

To stop spinning, tap the **Spinner** button again.



Note: Any changes in the numeric field are immediately reflected in the generated/simulated signal. You cannot exceed the minimum/maximum limits of a Function when spinning. The spinned value follows the resolution properties of the generated/simulated Function. If a numeric field is empty (displaying dashes), first use the soft numeric keypad to enter a value. Then you are able to utilize the spinning tool.

Current Generation (Source or Sink)

MC6-WS's current generation can be done using one of two available methods:

- MC6-WS provides a 24 volt loop supply voltage (source mode).

Setting: **Supply: On.**

- An external device provides the loop supply voltage (sink mode)

Setting: **Supply: Off.**

Connection depends on the loop supply setting. See pictures below.

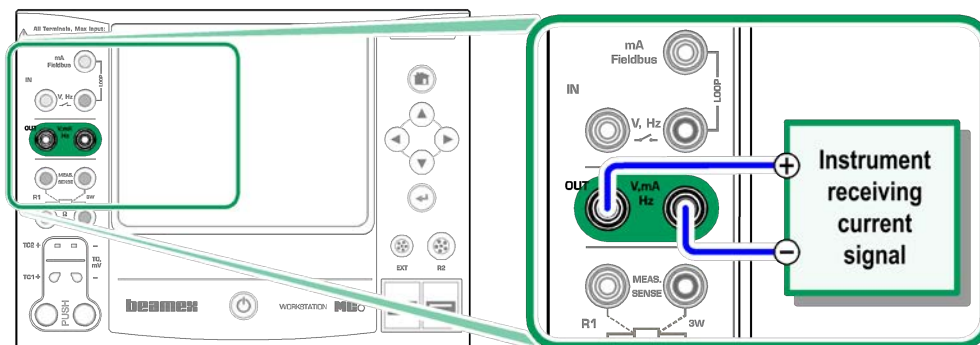

Figure 33: Current generation terminals. Internal supply. Range 0 ... 55 mA

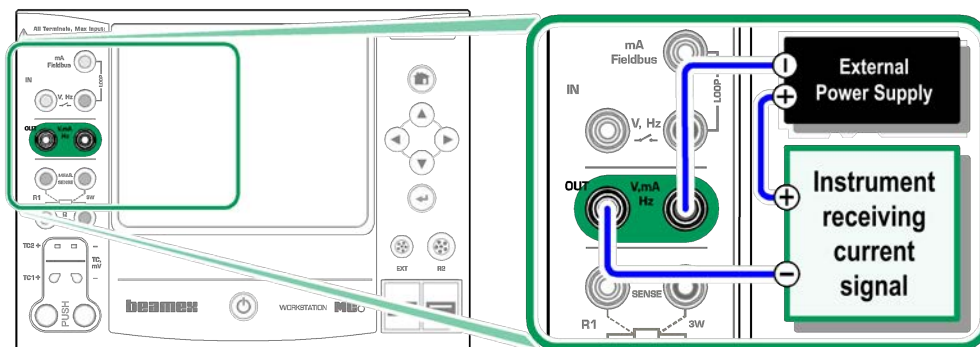

Figure 34: Current generation terminals. External supply

See also [Current Measurement](#).



Note: If the connected instrument utilizes digital communication and MC6-WS's 24 volt supply voltage is in use, the battery symbol is shown in the user interface of **Documenting Calibrator** and **Data Logger**.

Voltage Generation

MC6-WS has two voltage generation terminals. They are listed below (top to bottom) as they are shown in [Figure 35: Voltage generation terminals](#) (left to right).

- **TC1**, generation range: -1 to +1 VDC.
- **OUT**, generation range: -3 to +24 VDC.

Note that you may simulate non-supported thermocouple signals using **TC1** port. Since you actually generate (milli)volts, you need a data table to convert desired temperatures to millivolts.

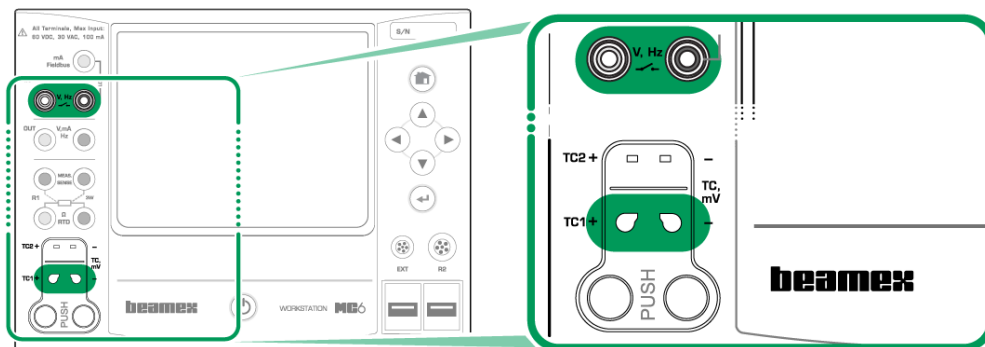

Figure 35: Voltage generation terminals

See also [Voltage Measurement](#) and [Thermocouple Simulation](#).



Note: It is advisable to enter 0 V output before connecting the circuit.



Warning: Short circuiting the voltage output may result in damage to MC6-WS and/or the connected instrument.

Thermocouple Simulation

Thermocouple simulation is available from TC1 terminals only.

Check the **Sensor Type**. Your simulations are unreliable unless you select the same sensor type as is connected to MC6-WS. Also select a suitable **Reference Junction** compensation method. Wrong Reference Junction setting yields useless results. See chapter [Thermocouple Connections](#).

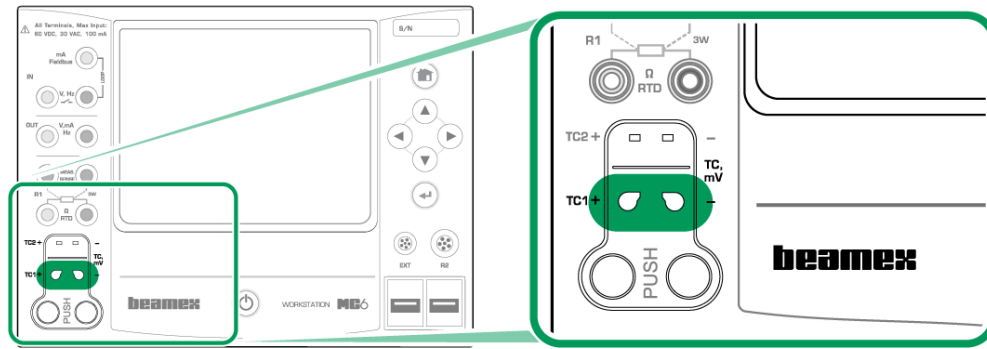

Figure 36: Thermocouple simulation terminals. Range depends on selected sensor type

See also [Temperature Measurement \(Thermocouple\)](#).



Warning: When using a thermocouple or an RTD sensor connected to MC6-WS to measure the external reference junction temperature: Keep in mind that there is no isolation between the instrument to be calibrated and the sensor measuring the reference temperature.



Note: Thermocouple measurements are error prone. There may be faulty connections, wrong (extension) cables and settings in MC6-WS. If unsure, see chapter [Thermocouple Connections](#) and study thermocouple literature.

RTD Sensor Simulation

RTD simulation is available from R1 terminals only.

Use of 2-, 3- or 4-wire connection is up to the receiving instrument. Connect the possible third and fourth wire according to the requirements of the connected instrument, but **use only the two leftmost R1 terminals in MC6-WS.**

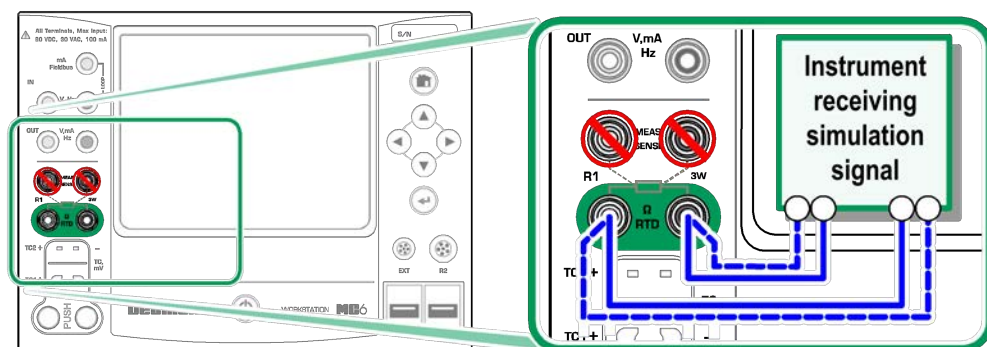

Figure 37: RTD simulation terminals. Range depends on selected sensor type

Check the **Sensor Type**. Make sure you select the same sensor as the instrument receiving the simulated signal requires. Otherwise your simulations are unreliable.

See also [Temperature Measurement \(RTD\)](#) and [Resistance Simulation](#).



Note: To ensure good contact between the device under test and the test leads, we recommend using the alligator clips provided with MC6-WS.

AC measurement current from the instrument under test is not supported. With pulsed measurement current, set a wait time of few milliseconds before the resistance is measured.

Resistance Simulation

Use of 2-, 3- or 4-wire connection is up to the receiving instrument. Connect the possible third and fourth wire according to the requirements of the connected instrument, but **use only the two leftmost RTD1 terminals in MC6-WS**. See [Figure 38: Resistance simulation terminals. Range 0 ... 4000 ohm](#).

MC6-WS monitors the resistance measurement current. If the current is too high, MC6-WS cannot simulate the right resistance value and displays an error message.

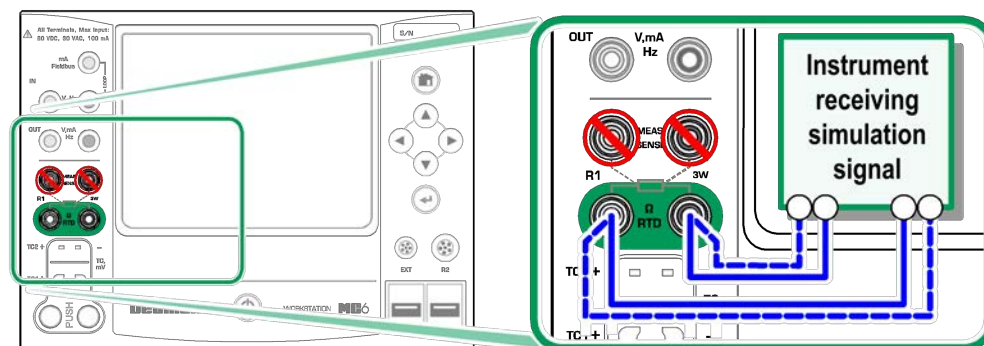

Figure 38: Resistance simulation terminals. Range 0 ... 4000 ohm

See also [Resistance Measurement](#) and [RTD Sensor Simulation](#).



Note: When simulating resistance or an RTD sensor, using R1 port, MC6-WS does not support measuring the simulated signal using R2 port.



Note: AC measurement current from the instrument under test is not supported. With pulsed measurement current, set a wait time of few milliseconds before the resistance is measured.

Frequency Generation

Before generating frequencies, the following settings should be checked:

- **Amplitude.** Defined from the button with the "V" value.
- **Waveform and Duty Cycle.** Set together from the rightmost button.

Duty Cycle is the ratio of the output high time to the total cycle time. Due to technical reasons, the entered Duty Cycle is not always realized with relatively high frequencies. When the realized Duty Cycle differs from the desired Duty Cycle, the realized Duty Cycle is shown with an asterisk (*) in front of it, e.g.:

□ *8%

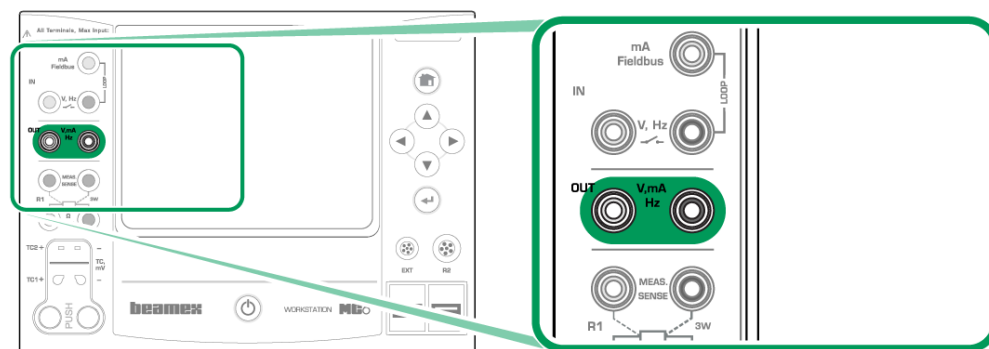

Figure 39: Frequency generation terminals. Range 0.0005 ... 50000 Hz

See also [Frequency Measurement](#) and [Pulse Generation](#).

Pulse Generation

Before generating pulses, the following settings should be checked:

- **Frequency.** To set the frequency, tap on the button with the "Hz" value.
- **Amplitude.** Defined from the button with the "V" value.
- **Waveform and Duty Cycle.** Set together from the rightmost button.

Duty Cycle is the ratio of the output high time to the total cycle time. Due to technical reasons, the entered Duty Cycle is not always realized with relatively high frequencies. When the realized Duty Cycle differs from the desired Duty Cycle, the realized Duty Cycle is shown with an asterisk (*) in front of it, e.g.:

□ *8%

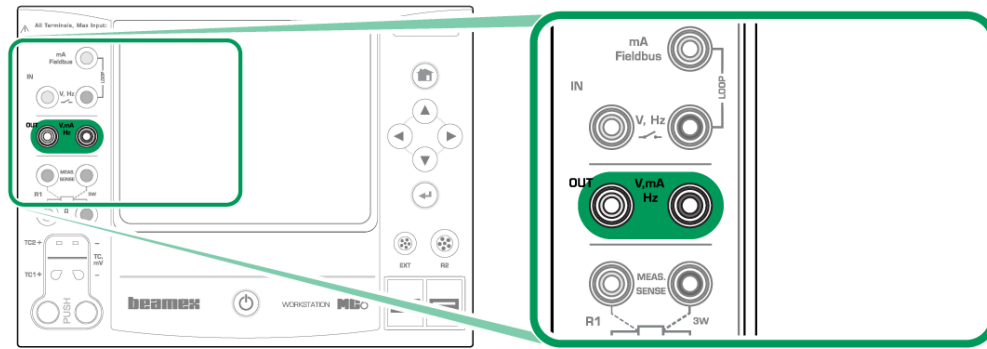

Figure 40: Pulse generation terminals. Range 0 ... 9 999 999 pulses

See also [Pulse Counting](#) and [Frequency Generation](#).

Thermocouple Connections

With thermocouples, connections and reference junction settings are crucial for getting accurate results. Reference Junction Modes available:

Internal is the simplest. Use suitable thermocouple, extension or compensation wires to connect to MC6-WS. MC6-WS takes care of the Reference Junction compensation. The picture below presents the connection to TC1 terminals. You may optionally also use the TC2 terminals.

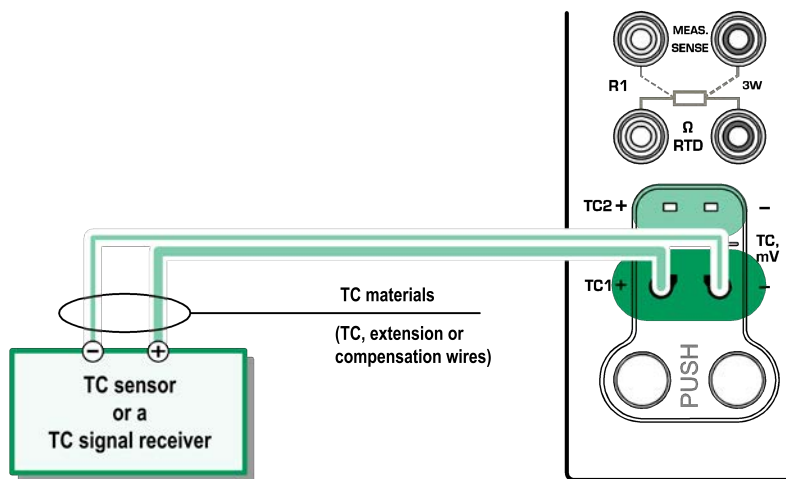

Figure 41: Internal Reference Junction

External R1 and **External R2** use an external RTD sensor measuring the Reference Junction temperature, connected to selected terminal. The picture below presents the connections to TC1 and R1 terminals.

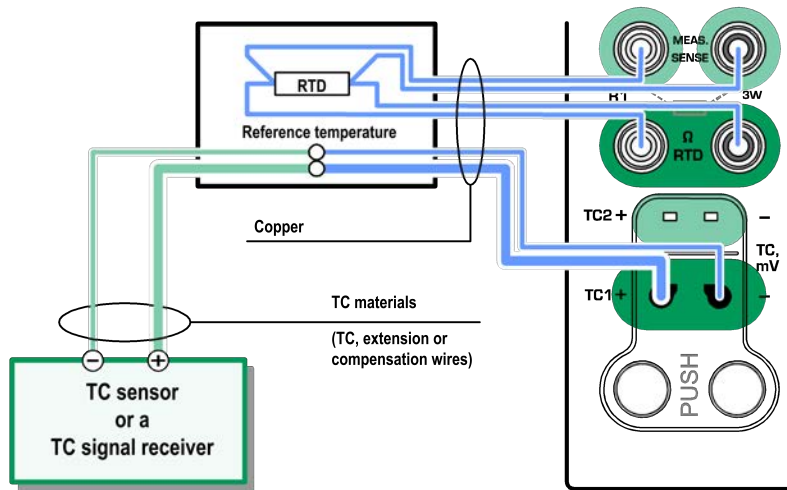

Figure 42: An RTD connected to R1 terminals measures the Reference Junction temperature

Fixed (0°C) and **Manual** are used when a compensation box, a temperature controller or similar method is utilized for fixing the Reference Junction temperature. **Manual** allows you to enter any temperature. **Fixed (0°C)** is a quick way of "entering" zero degrees centigrade. Connection picture to TC1 below.

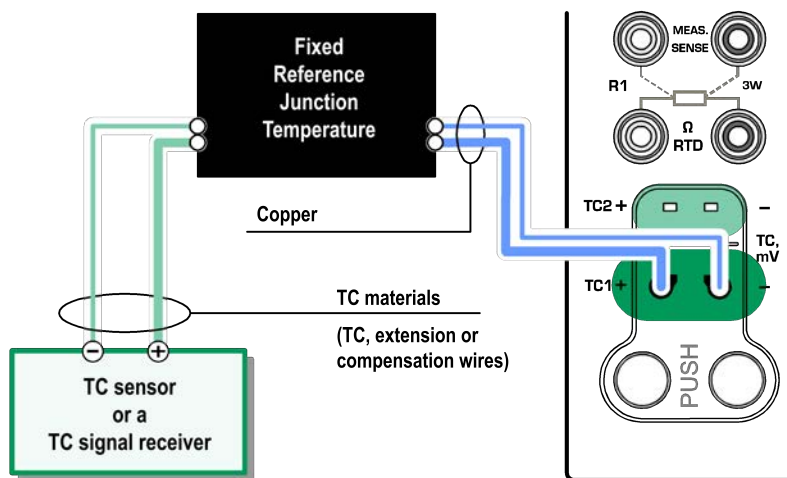

Figure 43: Fixed/Manual Reference Junction temperature



Warning: Before measuring, ensure that MC6-WS's temperature has stabilized. Temperature differences between MC6-WS and the environment affect the accuracy of TC measurements. In extreme conditions, wait up to 90 minutes.

Part 3, Meter

Things discussed in this part:

- Presenting the Meter and how to take it into use.

About Meter

The **Meter** can be used for quickly checking any device producing a signal that is measurable with MC6-WS. For calibration needs, use one the calibration related main functions available in MC6-WS.

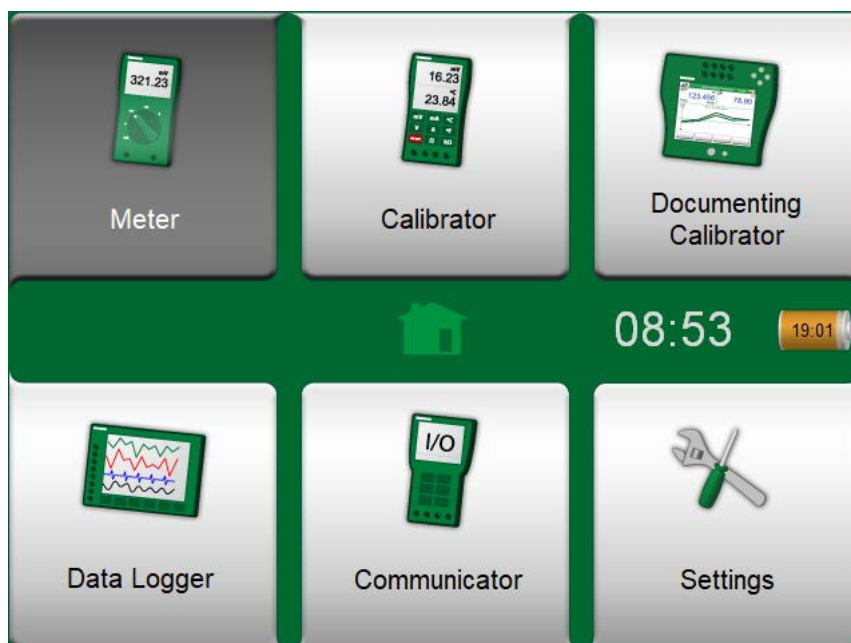

Figure 44: Home View with Meter selected

Start the Meter by tapping the Meter icon in MC6-WS Home View. A window opens (see [Figure 45: Current Measurement using Meter](#)). To measure a signal, do as follows:

- Select the **Quantity** of the signal by tapping one of the nine buttons on the lower part of the Meter window.
- Other, Quantity dependent settings appear on top of the Meter window.

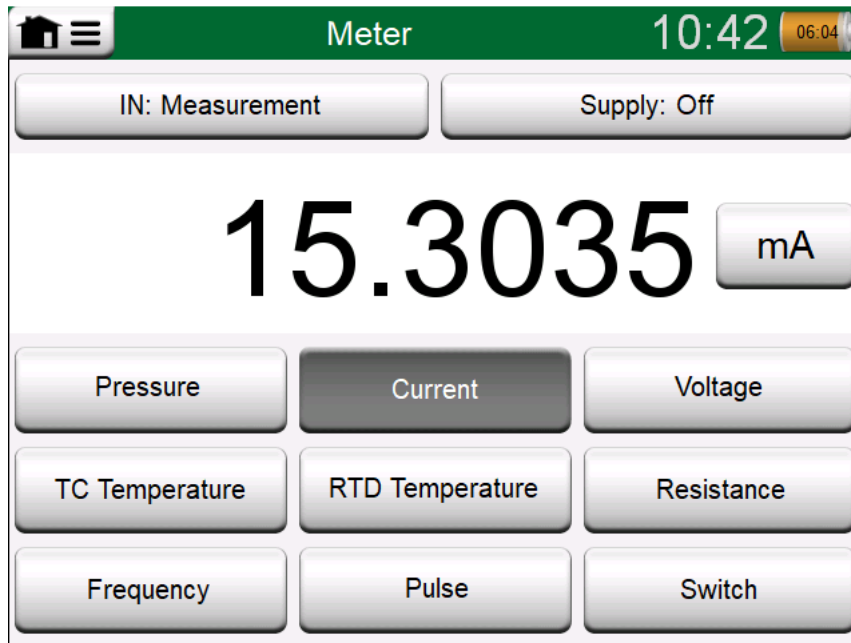

Figure 45: Current Measurement using Meter

For information on connections and essential settings, see [Part 2, Active Terminals and Connections](#).

Part 4, Calibrator

Things discussed in this part:

- How to use the Calibrator
- Presenting the available additional Tools in Calibrator.

About Calibrator

The **Calibrator** can be used for calibrating instruments. It consists of two subwindows which can be independently(* configured to measure, generate or simulate a signal. One subwindow for the instrument's input and another for the instrument's output.

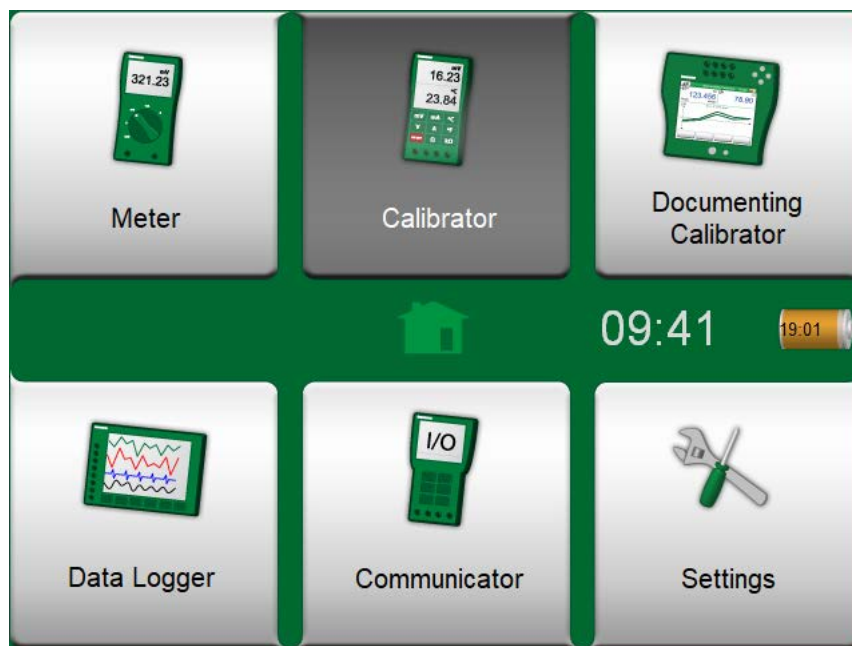

Figure 46: Home View with Calibrator selected

Start the **Calibrator** by tapping on the Calibrator icon in MC6-WS's Home View (see [Figure 46: Home View with Calibrator selected](#)). A window like the one in [Figure 47: Calibrator in use](#) opens. To configure a subwindow do as follows:

- Select the **Quantity** of the signal by tapping the button in the upper left corner of the subwindow. Hint: Quantity button has bold font.
- Other, Quantity dependent settings appear to the right of Quantity button. The button closest to the Quantity button defines whether you measure, generate or simulate a signal and which terminals are active.

For information on connections and essential settings, see [Part 2, Active Terminals and Connections](#).

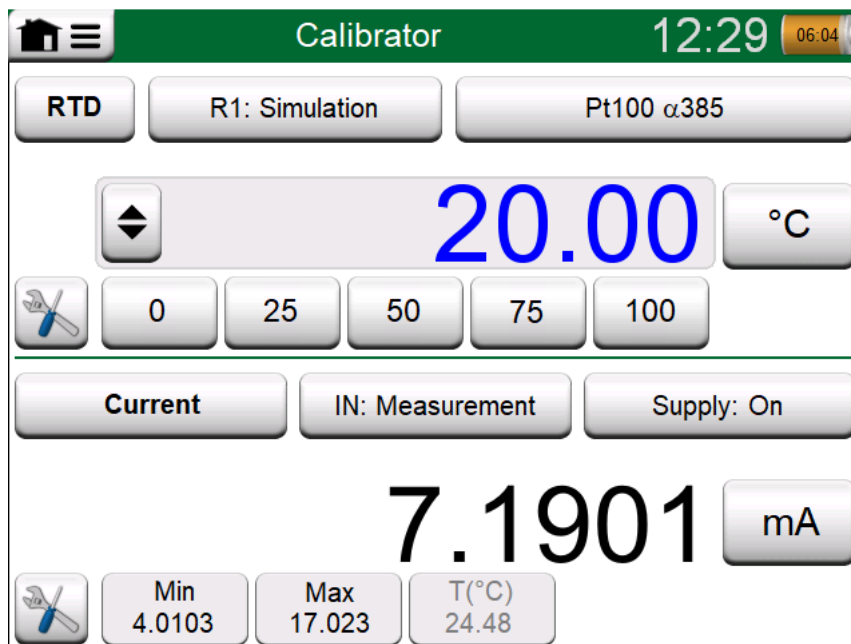

Figure 47: Calibrator in use



Note: If you want to document your calibration results, use MC6-WS's optional **Documenting Calibrator** feature or manually document the calibration data displayed in **Calibrator**.

For information on External Devices (Pressure and Temperature Controllers) used together with Calibrator, see [Part 9, Additional Information](#).

*) A measurement, generation or simulation in one subwindow reserve terminals in MC6-WS. This may affect the availability of measurements, generations and simulations in the other subwindow. To free terminals, tap on the quantity button and in the opened window, tap on the **"Stop"** button.

Tools

General

Calibrator window has **Tools** buttons in the lower left corner of each subwindow. See the picture below. The following list presents available tools. Certain tools are available for measurements only and others for generations/simulations only.



Figure 48: Tools button

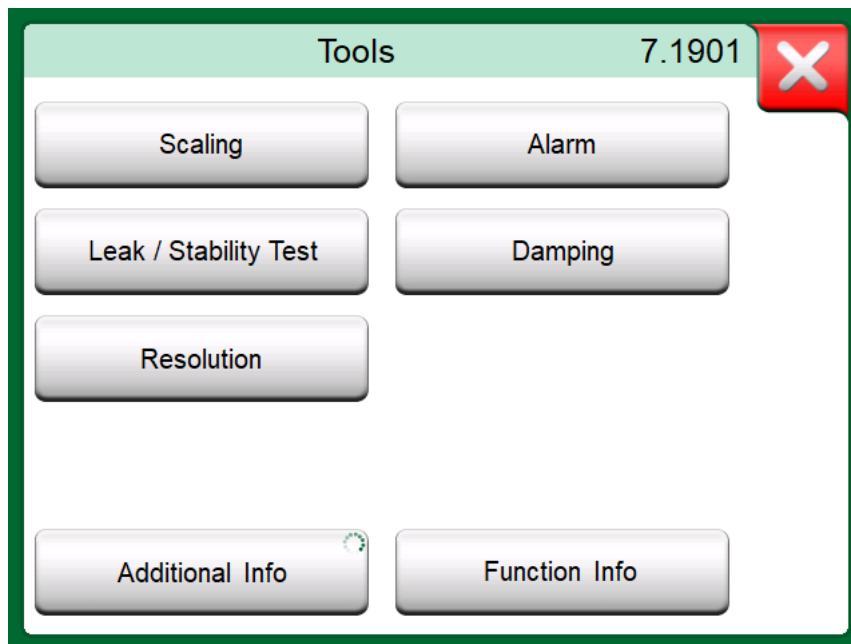





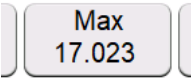





Figure 49: Tools available for measurements



Note: For practical reasons, the available Tools are limited for Switches.

Tool	Description
Scaling 	Any signal may be scaled provided the conversion is known. When scaling is active, it is indicated with a triangle in the unit button. The true measurement value is shown in the additional info row at the bottom of the subwindow.
Alarm 	Main measurements may be assigned with four alarm limits: high, low, high and low change rate. Active alarms are shown above the main measurement. When an alarm limit is exceeded, a warning signal is heard. A button for acknowledging an alarm appears when needed.
Leak / Stability Test	<p>A leak/stability test may be assigned to main measurements. It tests the leak or stability of, e.g. a pressure measurement system.</p> <p>In the Leak / Stability Test configuration window: Enter Test time and start recording. Use the "+30 sec" button to increase the test time, when needed.</p>

Tool	Description
<p>Damping</p> 	<p>Use damping when a measurement signal contains unwanted noise. Select one of the available options.</p> <p>When Damping is used, a funnel appears to the left of the main measurement. When damping is active, the following symbol is shown above the unit button:</p>  
<p>Resolution</p> 	<p>Any signal's resolution may be increased or decreased. Altered resolution is indicated in sub-window, e.g. "-2" equals two less decimals.</p>
<p>Additional Info</p> 	<p>Including additional information fields at the bottom of a subwindow is always available. The available fields, however, depend on the quantity/settings. Up to four fields may be added to both subwindows. The additional information row settings are saved for future needs.</p>
<p>Function Info</p>	<p>Always available. Opens a pop-up window with information of current function (measurement range, uncertainties etc.).</p>
<p>Step</p> 	<p>Available for generations/simulations: Opens a window for defining a step function for the generated/simulated signal.</p>
<p>Ramp</p> 	<p>Available for generations/simulations: Opens a window for defining a ramp function for the generated/simulated signal.</p>
<p>Quick Access</p> 	<p>Available for generations/simulations: Opens a window for defining five shortcuts to user configurable generation/simulation values. Quick Access buttons appear at the bottom of the subwindow, taking over the space of possible additional info data.</p>



Note: Several Tools have a "Stop" button in the pop-up window the Tool is configured in. To stop, e.g. Damping, open the Damping configuration window and tap the "Stop" button. Then MC6-WS reverts to default damping settings.

Changing the Quantity of a subwindow revert all Tools, except Additional Info settings, to their default settings for that particular Quantity.



Note: In **Calibrator** window: the additional info fields with black text may be zeroed "on the fly". Zeroing options are available in **Additional Info** window's menu.

Some of the tools presented here are also available in **Documenting Calibrator** and **Data Logger**.

Part 5, Documenting Calibrator

Things discussed in this part:

- An introduction to calibration
- How to calibrate instruments using MC6-WS's Documenting Calibrator
- How to do a Group Calibration
- How to view calibration results
- How to read instrument data from devices using digital communication.

General

MC6-WS's **Documenting Calibrator** is an optional, more advanced tool than the "plain" **Calibrator** that is also available in MC6-WS. If your MC6-WS does not have this option installed, the **Documenting Calibrator** icon is disabled.

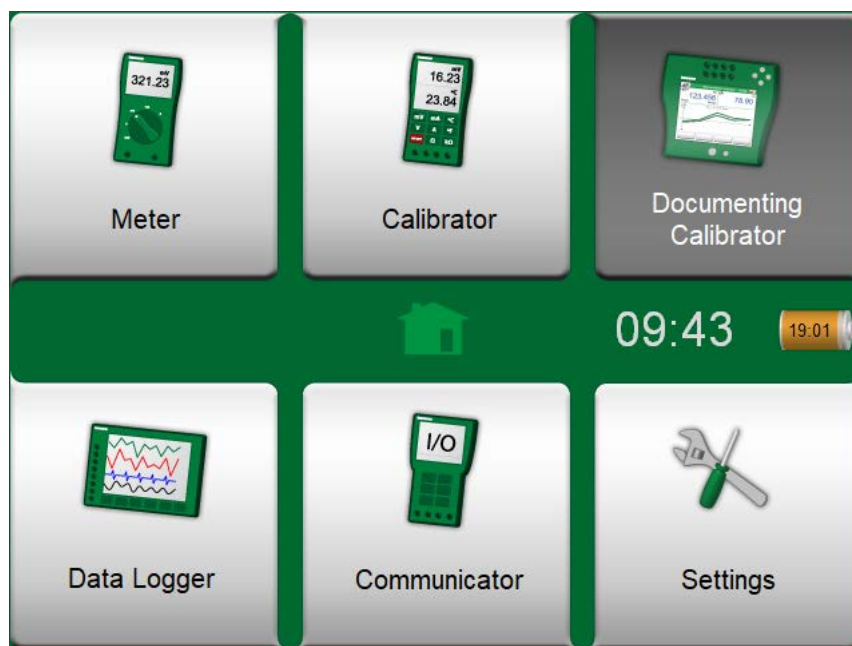

Figure 50: Home View with Documenting Calibrator selected

Documenting Calibrator saves instrument data and presents them in a list. Instrument data consists of input and output quantities and ranges as well as other data that defines the instrument. Starting to calibrate an instrument is fast, since all the required data are immediately taken into use.

Instruments to be calibrated may be received from calibration software communicating with MC6-WS. Alternatively, instruments may be created in MC6-WS itself.

Calibration results are saved and they can be viewed in MC6-WS and also sent to calibration software for further analysis.

Open **Documenting Calibrator** by tapping on the **Documenting Calibrator** icon in MC6-WS's Home View (see [Figure 50: Home View with Documenting Calibrator selected](#)).

Calibration Software

When this manual was printed, the following calibration software supported communication with MC6-WS:

- **Beamex CMX Calibration Management Software**, version 2, revision 2.9 onwards, Professional and Enterprise editions.
- **Beamex LOGiCAL**, a cloud based tool for handling calibration results.



Note: Older Beamex calibration software do not support MC6-WS.

Calibrating Instruments

Instruments are typically calibrated following the procedure shown in [Figure 51: Typical calibration procedure](#).

In MC6-WS, you first select (or create) the instrument to be calibrated. Then perform the As Found calibration – as many repeats as is required - and decide whether or not adjustment is needed. Often you then do the required amount of As Left repeats to document the instrument's state after the possible adjustment.

A calibration procedure using MC6-WS is presented in the following subchapters.

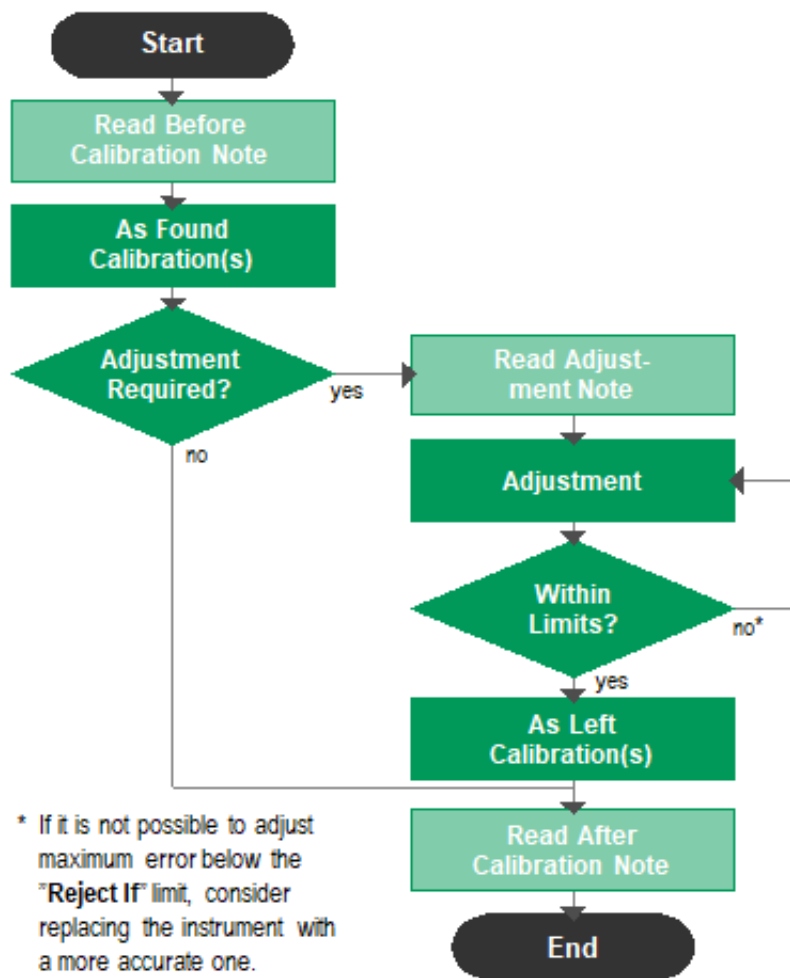

Figure 51: Typical calibration procedure



Note: Although MC6-WS assists you in doing the calibration, you need to know how instruments are calibrated; be, e.g. a calibration technician. **MC6-WS is a tool for calibration professionals.**

Generating/Simulating the Input Value

How you change the generated/simulated value is explained in [Part 2, Active Terminals and Connections](#), chapter [Changing the Generated/Simulated Value](#).

Instrument List

When you start the Documenting Calibrator, you arrive in **Instrument List** window. See [Figure 52: Example of an Instrument List](#) for an example of an Instrument List.

MC6-WS allows you to hierarchically organize your instruments into a Plant Structure. The Instrument List window may contain both instruments (gray

items) and Plant Structure Levels (yellow items). The following subchapters present features available in Instrument List window and its menu.

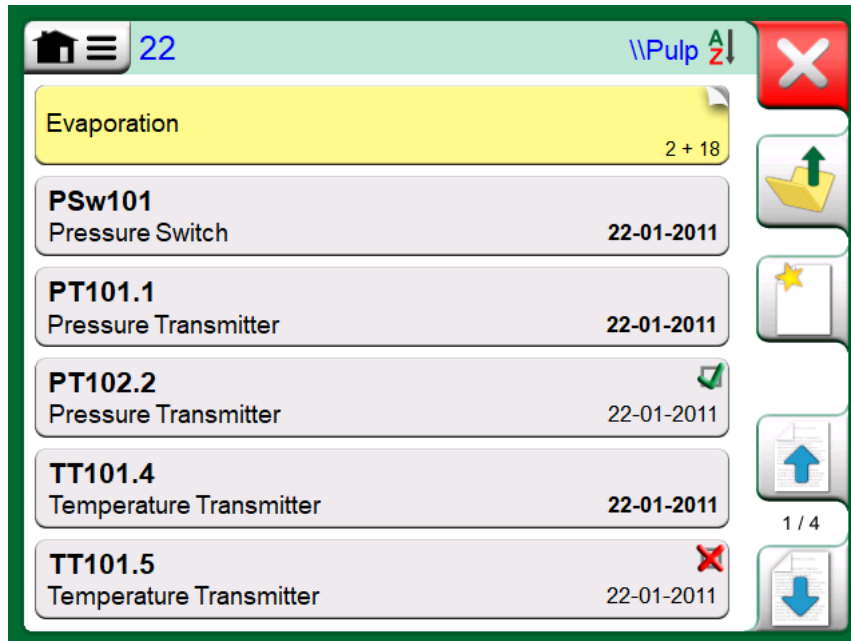

Figure 52: Example of an Instrument List



Note: The Instrument List may be several pages long. Remember to use the page browse buttons available on the right side of the window.

Instruments

Instruments have a gray background in the Instrument List window. The instrument's upper text row displays the contents of one of the following fields: **Position ID**, **Name**, **Device ID** or **Device Serial Number**. The first non-empty of the aforementioned fields, in presented order, is displayed. The second row displays (possible) Function Name and Calibration Due Date data.

If the instrument has been calibrated, the rightmost end displays an icon. The displayed icon depends on whether the **instrument's** latest calibration "**Passed**", i.e. the found maximum errors were smaller than the instrument's "**Reject If**" error limit, or did it "**Fail**".

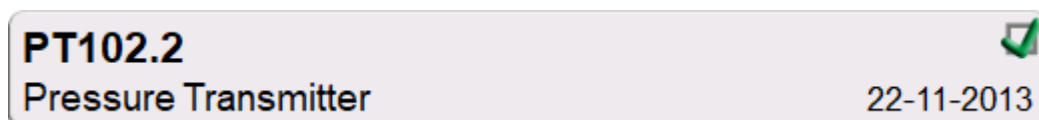

Figure 53: Instrument's latest calibration "Passed"

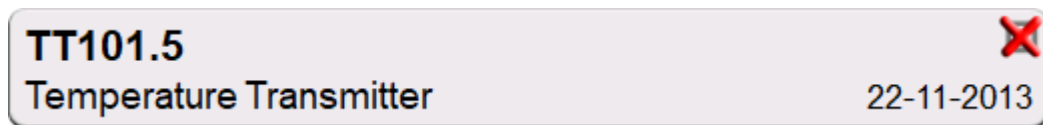

Figure 54: Instrument's latest calibration "Failed"

To **select** an instrument for calibration, tap on it. Then the [Instrument Overview Window](#), opens.

To create a **new instrument**, tap the "Create New Instrument" button. See [Figure 55: "Create New Instrument" button](#). Then several pages of instrument configuration data opens. Note that by default only basic pages are shown. View all pages by selecting **Show, All Pages** from the menu available when creating/editing an instrument.



Figure 55: "Create New Instrument" button

To **delete** an instrument, select it and use the delete command available in the menu of opened [Instrument Overview Window](#).

Plant Structure Levels

The name of the current Plant Structure Level is shown on the status bar. Tap on the bar to see the full Plant Structure path. Plant Structure Sublevels have yellow background and the upper right corner is folded. The Level's name is displayed and on the lower right corner, the amount of further Sublevels + the amount of instruments found on the next Sublevel.

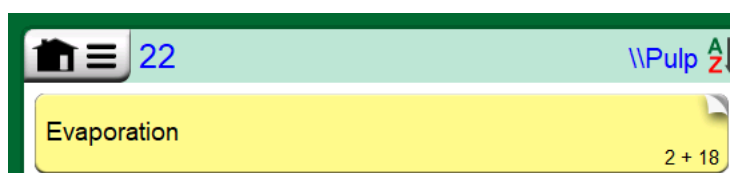

Figure 56: Current Plant Structure Level is called "Pulp". A total of 22 instruments are located on this Level and all its Sublevels. Sublevel "Evaporation" has two Sublevels and 18 instruments

To **select** a Plant Structure Level, tap on it. Then the contents of that level are displayed. To **return** to the previous level, tap on the "Back" button found on the right side of the Instrument List window.



Figure 57: "Back" button

Creating and managing **Plant Structure Levels** is presented in chapter [Instrument List Window Menu](#).



Note: Deleting a branch level also deletes all instruments and calibrations found on that level and all its sublevels. You cannot delete the structure root level.

Instrument List Window Menu

The Instrument List window's menu contains a lot of useful tools:

- **Create New** for creating a new Instrument etc. (See [Figure 58: Instrument List Window's menu](#))
- **Sort** for sorting the list contents alphabetically etc. Sorting icons shown in status bar (ascending / descending):

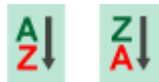



Identification



Due Date



Creation

- **Show** to display all or filter to a selected group of items in the list. The group can be, e.g. all calibrated instruments. When filtering is active, the following icon is shown in the status bar: 
- **Plant Structure** for defining how the Plant Structure is shown.
- **Browse** to jump to start/end of list or finding instruments. When find is in use, the following icon is shown in the status bar: 
- **Manage** for deleting all Instruments/Results/Plant Structure levels and also for moving/renaming Plant Structure levels.

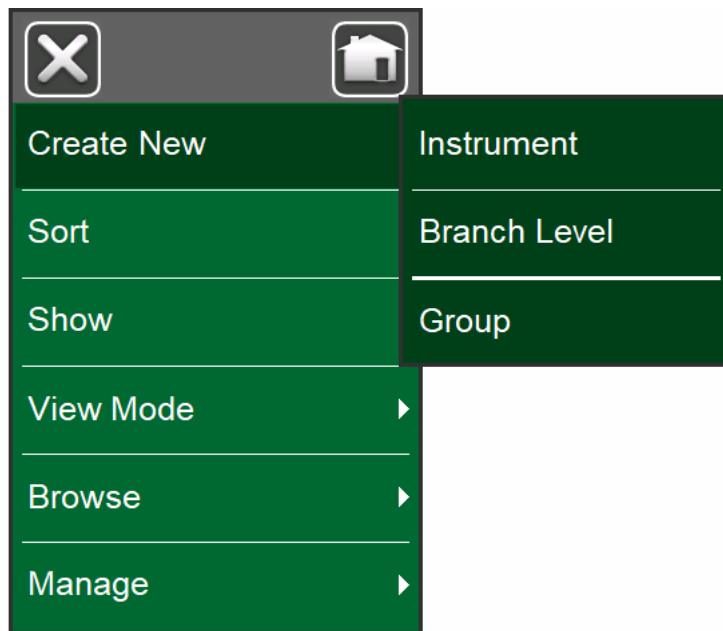
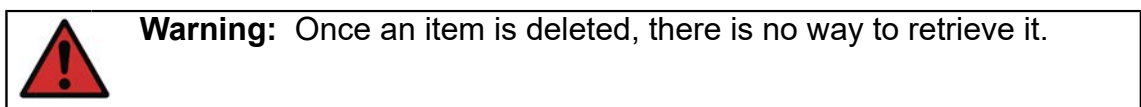

Figure 58: Instrument List Window's menu



Instrument Overview Window

When an instrument is selected, the **Instrument Overview** window opens and general data of the selected instrument is presented.

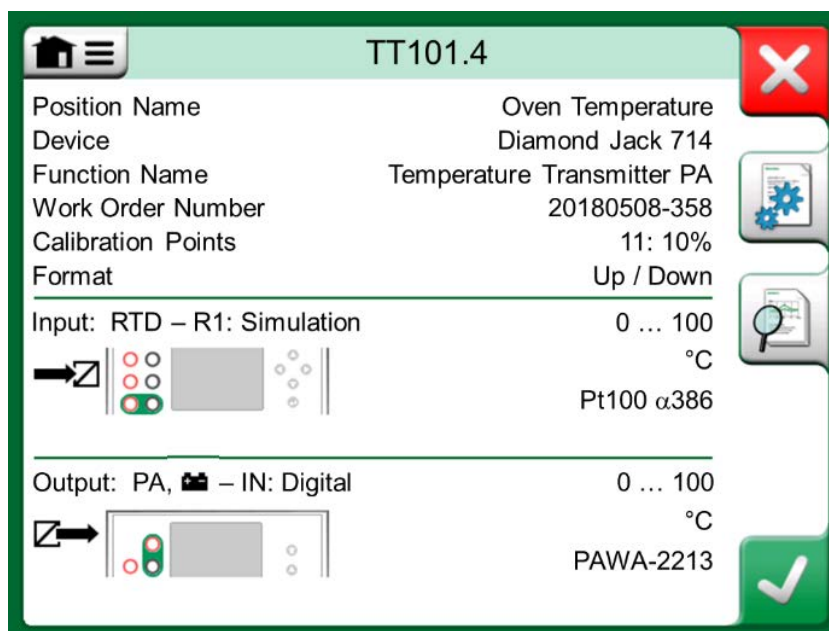

Figure 59: Instrument Overview Window

With the help of the buttons on the right side of the window, you may:

- edit/check the instrument data,
- view calibration results for this instrument (if applicable) or
- start calibrating the selected instrument and open the calibration window (from the check mark on green background).

The bulleted list above is presented in the same order as the icons are in **Instrument Overview** window.

Note that the menu contains some useful instrument related tools.

Calibrating an Instrument Using MC6-WS

When you start calibrating an instrument, the **Calibration** window opens. See the picture below. Note that a possible **Before Calibration Note** window may open before the **Calibration** window is shown.

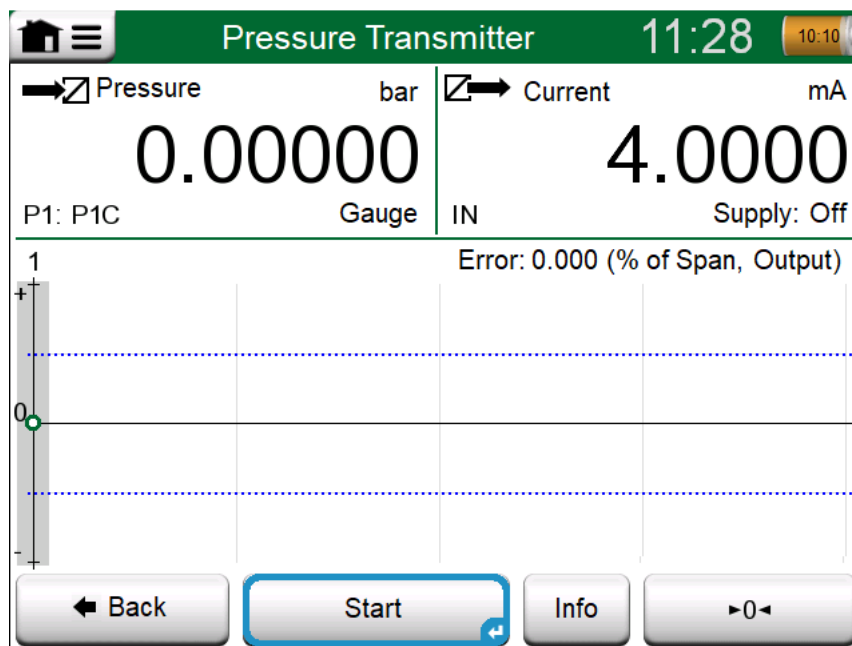

Figure 60: Button for zeroing a pressure module in the lower right corner

Before you tap the **Start** button, ensure that the signals are "live", i.e. measurements and the required connections are as they should. If unsure, use the connection diagrams found in the Instrument Overview Window. It opens from the **Info** button.

If gauge pressure modules are used in the calibration, remember to zero them before starting the calibration.

Tap the **Start** button to begin calibration. The rest depends on the instrument setting: **Automatic Acceptance**.

When **Automatic Acceptance** is in use (checked), MC6-WS accepts calibration point automatically as follows:

1. MC6-WS uses the **Max. Point Deviation** value to see if the input signal is close enough to the next calibration point.
2. When close enough, MC6-WS checks the signal stability to decide whether the readings can be saved or not.
3. When signal stability is reached, a timer counts down as set in **Point Delay** and then the readings are saved only if the signal stability is still valid. See hourglass in [Figure 61: Calibration with Automatic Acceptance in use](#). If a signal becomes unstable, MC6-WS returns to phase 2.

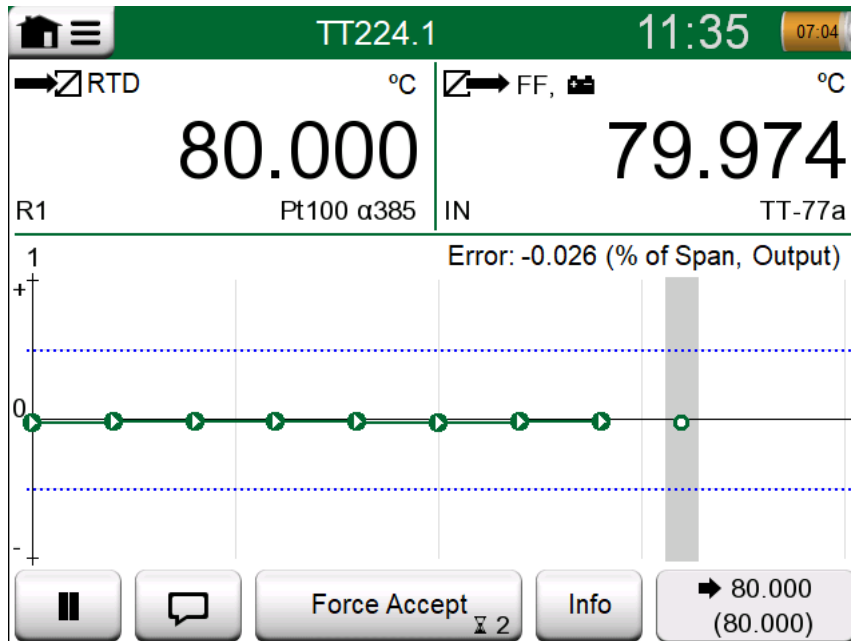

Figure 61: Calibration with Automatic Acceptance in use

Use the **Force Accept** button to manually accept points when, e.g. the calibration does not advance because of an unstable input and/or output signal.



Note: Opening the menu during calibration pauses the calibration for as long as the menu is open.

When **Automatic Acceptance** is not in use, every calibration point is manually accepted. Then tap the **Accept Point** button seen in the Calibration window. See the picuter below.

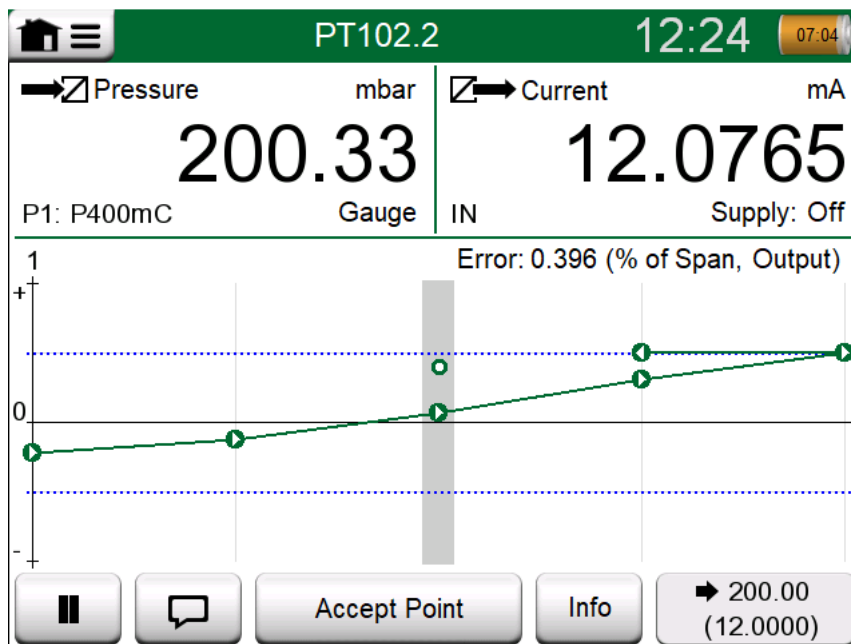

Figure 62: Calibration with manual acceptance

As the calibration advances, the graph is drawn from point to point. A grey column indicates where next target point is. The width of the grey column is based on **Max. Point Deviation** setting. Numeric values for the next target point can be seen in the lower right corner. If any of the points exceed the error limits (blue dotted lines), the graph is colored red.

The **Pause** (||) button allows you to reject a calibration or undo a point. The button with the "speech bubble" allows you to add notes to each calibration point. For further options, open the menu.

If you need to change the Pressure Module during the calibration, see chapter [Changing the Pressure Module During Calibration](#).



Note: Certain tools available in **Calibrator** are also available in **Documenting Calibrator**. To see the tools, open **Calibration** window menu, select either **Input** or **Output** and from the opened window, tap on the **Tools** button. The available tools depend on the Quantity and Port selected for the input/output. The same tools are also available when editing the instrument data.

When the calibration is completed, the first of Calibration Result window's pages open telling you whether the calibration **Passed** or **Failed**. Browse through the pages to get an overview of the calibration results. Note that the amount of pages shown depends on the setting found in the window's menu. To see the basic pages only, open menu and select **Show, Basic Pages**. To see all pages open menu and select **Show, All Pages**.

PT102.2 Pressure Transmitter ✓

Calibrated by
Andy Handyman

Notes

2 / 5

Figure 63: Calibration results page for entering calibrating technician's name, and possible notes

Input [mbar]	Output [mA]	Error [% of Span]	Significance [%]
0.00	3.9650	-0.2191	43.8
50.00	5.9725	-0.172	34.4
100.00	7.9800	-0.125	25.0
150.00	9.9950	-0.031	6.2
200.00	12.0100	0.062	12.5
250.00	14.0300	0.188	37.5
300.00	16.0500	0.313	62.5
350.00	18.0600	0.375	75.0
400.00	20.0700	0.438	87.5

4 / 5

Figure 64: Numeric calibration results page. For results including more than nine calibration points, use the scroll buttons or scroll bar to view hidden data

Save or delete the results using the buttons available on the right side of the window. When saving: In the following window: Tap on the **Combine with Previous Result** check box, if you want to combine the most recent result with previous results. When checked, calibration software treats all combined results as one calibration event containing several repeats.

After saving the results, you are brought back to the **Calibration** window where you may either start another calibration repeat or choose the **Back** button, to end calibration for this instrument.

Changing the Pressure Module During Calibration

If a calibration requires the use of several Pressure Modules, the Pressure Module has to be changed "on the fly". To do it, open **Calibration** window menu, select either **Input** or **Output** (depending on where the Pressure Module is connected). In the opened window:

- If the module to be used is internal or you are changing from an Internal Pressure Module to an already connected External Pressure Module, just tap the button below **Port/Function** text and select it from the available Pressure Modules.
- If you want to change the External Pressure module in use to another External Pressure Module connectable to the same port as the one currently in use, tap on the button seen in [Figure 65: Switching/changing an external pressure module..](#) Continue with the change as explained on MC6-WS's display.



Figure 65: Switching/changing an external pressure module.

About Fieldbus and HART Device Specifics

Detailed information of fieldbus and HART device specifics are discussed in [Part 7, Communicator](#). However, here are some hints on where fieldbus and HART device related features appear in Documenting Calibrator.

Adding fieldbus and HART Instrument to MC6-WS's database

When adding a fieldbus instrument or a HART instrument's digital output to MC6-WS's database, select **HART**, **FOUNDATION Fieldbus H1** or **Profibus PA** as the output quantity. See the picture below.

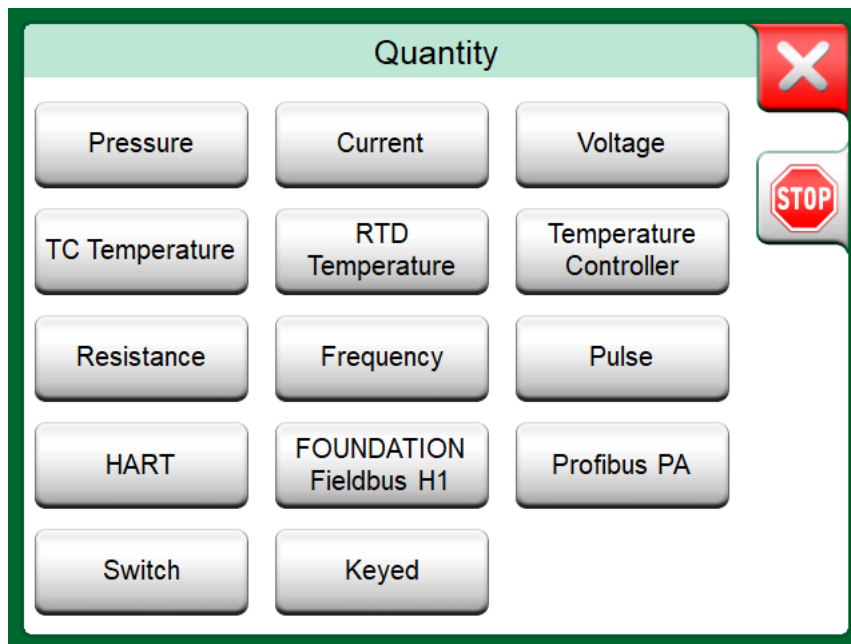

Figure 66: Documenting Calibrator's quantity selection window



Note: For HART instrument's **analog output**, select **Current** as the output quantity.

See also chapter [Digital Communication and MC6-WS's Instrument Data](#).

Additional utilities during calibration

During Calibration, MC6-WS's menu has additional menu options available: For both HART and fieldbus instruments: a possibility to invoke the communicator to edit instrument data and when needed, start a HART trim method. For fieldbus instruments, an additional menu option for trimming the instrument is also available.

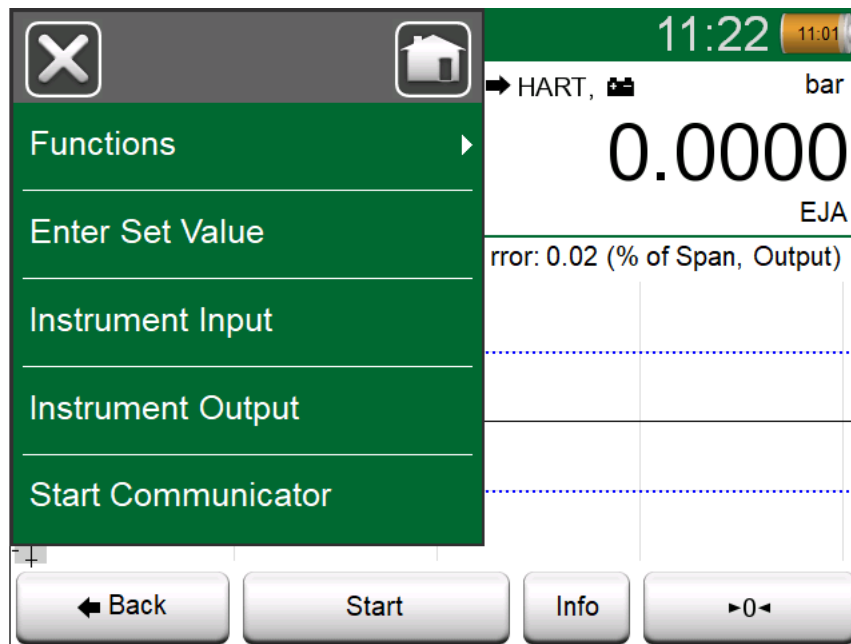

Figure 67: Menu in Documenting Calibrator when calibrating a HART instrument

Group Calibration

MC6-WS's **Group Calibration** allows you to simultaneously calibrate several Instruments/Functions. This is practical, e.g. when calibrating Instruments/Functions that are part of a loop, or when input generation takes time (temperature) and there are several devices to be calibrated.



Note: Switches are not supported in group calibration. All other type of instruments/functions can be included in a group.

Collecting Instruments/Functions for Group Calibration

To start collecting Instruments/Functions to a group, open the **Documenting Calibrator's Instrument List** window: Open the menu and tap on **Create New** to see the submenu where Grouping can be activated. See the picture below.

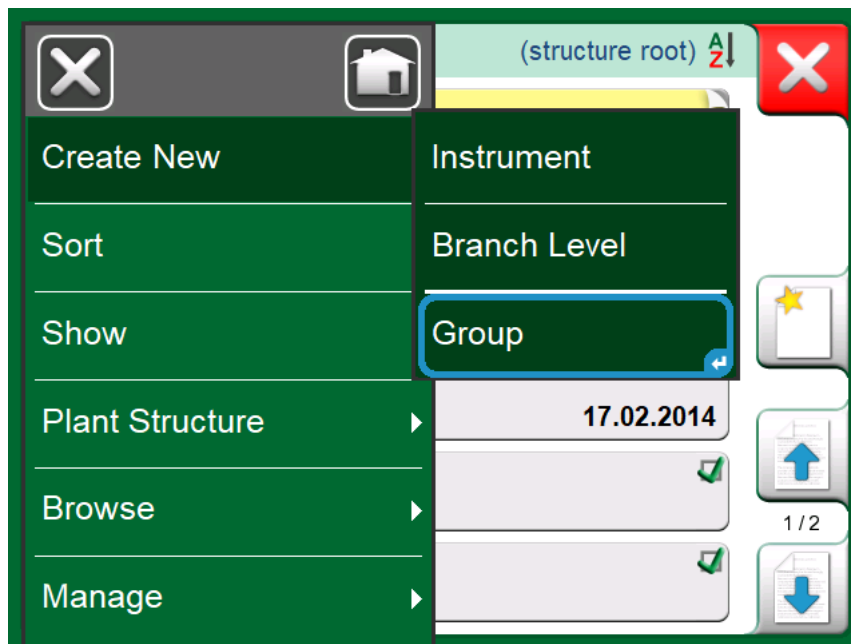

Figure 68: Activating a Group

Collect Instruments/Functions by tapping on each Instrument/Function you want to add to the group. In the **Instrument Overview** window, tap on the **Add to Group** button. See the picture below. The Hardware Focus Indicator is on the **Add to Group** button.

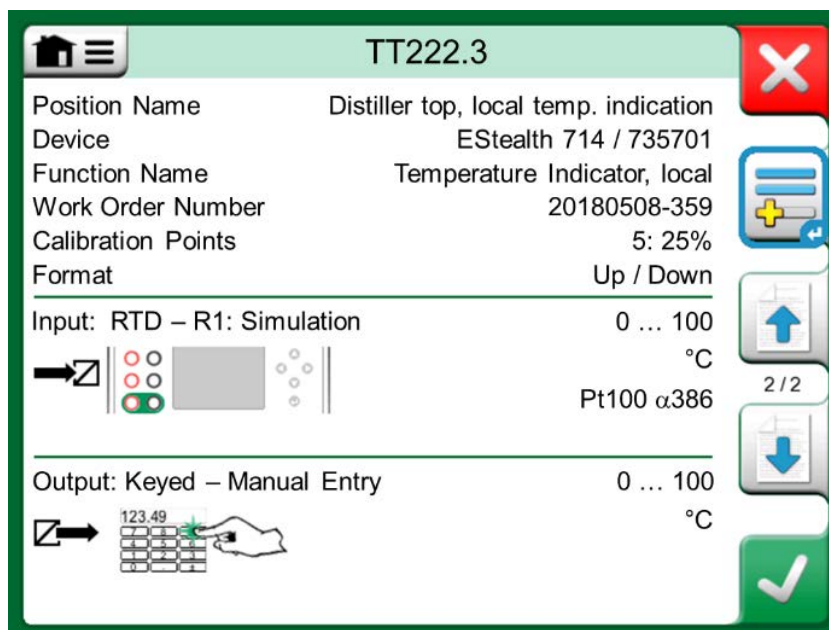

Figure 69: Hardware Focus Indicator on "Add to Group" button



Figure 70: Instruments/Functions selected in a group have blue background in the Instrument List

Editing a Group

By default, the Instruments/Functions are calibrated in the order they were included in the group. However, the **Instrument Overview** window's menu includes a possibility to sort the group according to your own needs. The same menu also includes a possibility to cancel the Group or to remove the current Instrument/Function from the Group (in the **Instrument** menu option's submenu).

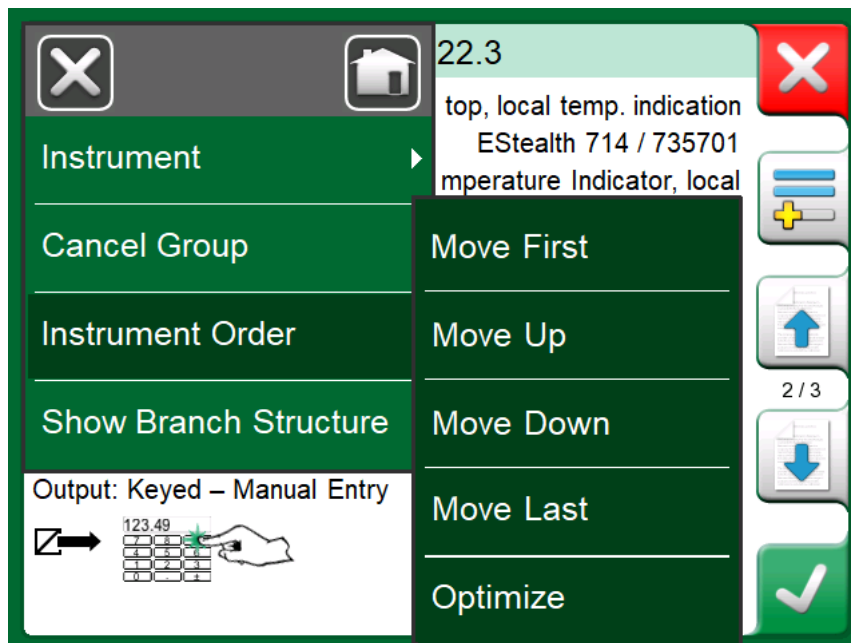

Figure 71: Sorting the Instruments/Functions in a group

Menu item **Instrument Order**, **Optimize** sorts the items automatically so the first instrument to be calibrated has the smallest/lowest calibration point of all instruments in the group.



Note: The **Instrument Overview** window's buttons change when Group Calibration is active. In addition to **Add to Group** button you have browse buttons for browsing through the Instruments/Functions selected to the Group. **Instrument Settings** and **Calibration Results** are moved to the **Instrument Overview** window's menu.

Calibrating a Group

Calibration is started the same way as the calibration of a single Instrument/Function; by tapping the **Instrument Overview** window's **Accept** button. The **Calibration** window opens displaying the Group's first Instrument/Function.

The text in the **Calibration** window's **Info** button has changed to indicate which Instrument/Function is currently shown in the window (1/3 in [Figure 72: Settings and Group Settings](#)). The functionality of the button is the same.

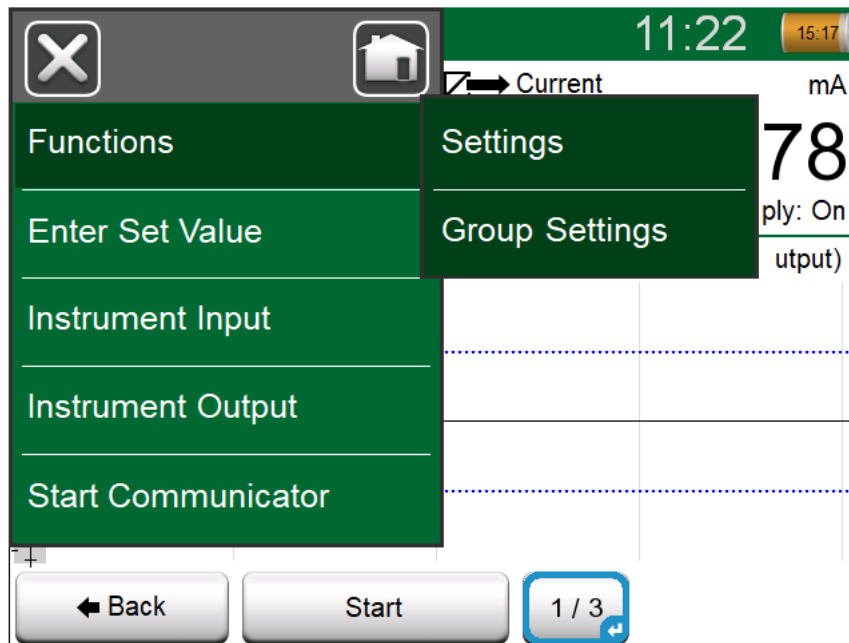

Figure 72: Settings and Group Settings

Before starting, check the settings in the **Calibration** window's menu:

Settings include the possibility to show the **Function Name** in the Title Bar. It may be a more descriptive text when calibrating a group of Instruments/Functions belonging to a loop. In **Group Settings** you can define when the **Instrument Overview** (Instrument info) window appears during Group Calibration.

Group Settings

In **Group Settings** you can define two things:

- **Calibration Point Sequence**, i.e. how the calibration points are run through. More details below.
- When the **Instrument Overview** (Instrument Info) window appears during Group Calibration.

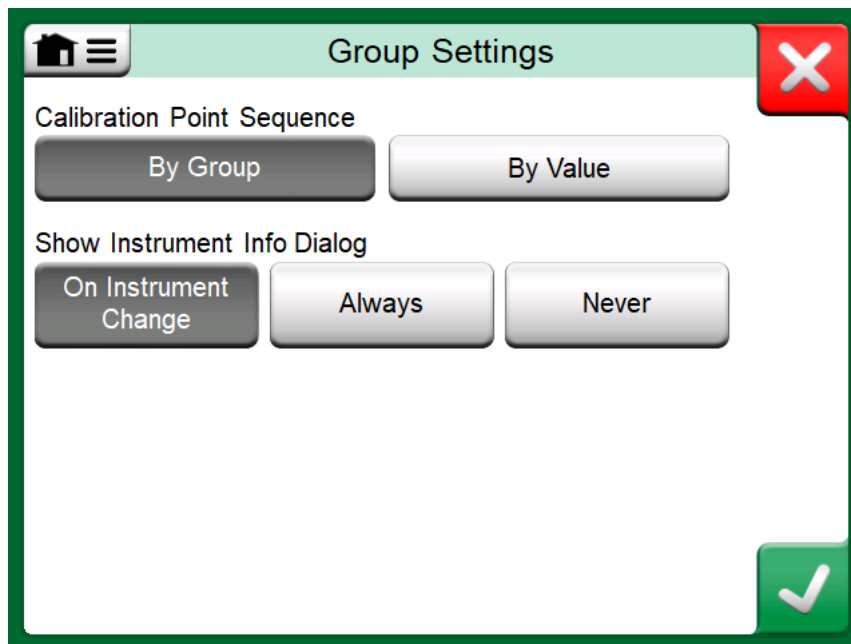

Figure 73: Group Settings Window

Calibration Point Sequence options:

- **By Group:** Suitable when all instruments selected into the group have the same input span. The instruments may have different amount of calibration points as long as the input span is the same.
- **By Value:** The instruments selected into the group may have a span of any size. The only important thing is: **The group's first instrument has to have the smallest/lowest calibration point of all instruments in the group.** When necessary, use the sorting tool presented in chapter [Editing a Group](#).



Note: Remember to change connections (if necessary) when the Instrument/Function changes during the Group calibration.



Note: Examples of Instruments/Functions suited for Group Calibration:

- A measurement loop, including a temperature transmitter, a local temperature indicator and a temperature indicator in the control room.
- A set of temperature sensors calibrated simultaneously using, e.g. a dry block.

Performing the Calibration

The actual calibration is done from point to point similarly as a non-Group Calibration. You may change the default calibration order of Instruments/Functions by tapping the Info button and selecting another Instrument/Function by browsing the Instrument Overview window.

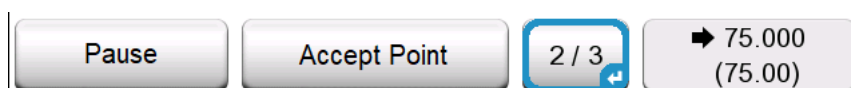

Figure 74: Info button highlighted (2nd instrument of a group of three @ 75 °C)

After all points of all Instruments/Functions are done, the calibration result pages open one by one and you have the chance to save (or not) the calibration results for each Instrument/Function in the Group.

When the results of all Instruments/Functions are saved (or not), MC6-WS returns to the **Calibration** window. Now you may do another calibration run or return to the instrument list to, e.g. remove Instruments/Functions from the Group that did pass in the As Found test and leave the Instruments/Functions in the Group that require As Left calibration.

Calibration Results

Once an instrument has been calibrated, you may view saved calibration results as follows:

- When viewing the **Instrument Overview Window**, select the **Calibration Results** button.

The most recent saved calibration is presented. If you want to see older results, open the menu in **Calibration Results** window and select **Results History**. Then a list presenting all saved results opens. See the picture below.

To separate calibration events from each other, they have a different shades of gray background colors. If the instrument's settings have changed, a field with blue background is seen. Tap it to see the settings as they were before that date/time.

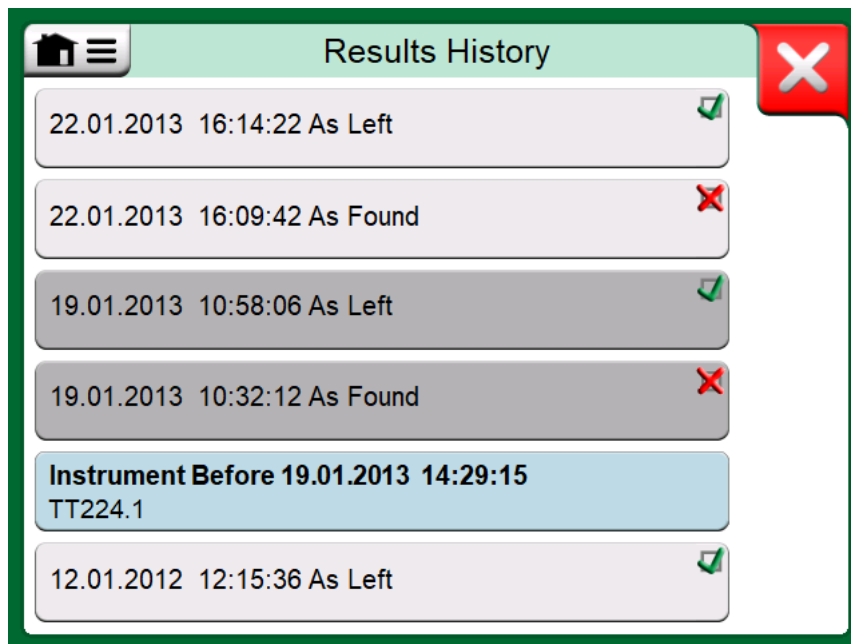

Figure 75: Calibration results history window



Note: Saved calibration results cannot be edited.

Deleting Calibration Results

When viewing the results of a calibration, you may delete the currently viewed result (menu option **Delete This Result**) or remove all results related to current instrument (menu option **Delete All Results**).

You may also remove all results related to current instrument in **Results History** window: Select menu option **Delete All Results**.



Warning: Once the results are deleted, there is no way to retrieve them.

Digital Communication and MC6-WS's Instrument Data

With this feature, you may add instrument data to MC6-WS from Instruments using Digital Communication:

- **HART**[®] instruments,
- **FOUNDATION Fieldbus H1**[™] instruments and

- **PROFIBUS PAtm** instruments

All you need is connect the instrument to MC6-WS, select a communication protocol and receive data of the Instrument using Digital Communication to MC6-WS's Instrument Data. No error prone manual entry of Instrument Data.

MC6-WS has pre-entered default mappings (which Digital Communication Instrument field goes to which field in MC6-WS) but you may customize the mapping for each instrument model you use.



Note: Utilizing this feature requires that your MC6-WS has the Documenting Calibrator option as well as the option to communicate with the smart instrument type (Fieldbus option) you want to add to MC6-WS's instrument data.

You may easily populate CMX's Instrument database by first mapping instrument data to MC6-WS and then transferring the instruments to CMX.

More of Instrument's utilizing Digital Communication can be found in [Part 7, Communicator](#).

Getting and Editing Mapped Data

Preparations

The data mapping can be done to a new instrument or to an existing instrument in MC6-WS. The Instrument's Output has to be one of the following:

- Current (measurement),
- HART[®],
- FOUNDATION Fieldbus H1tm or
- Profibus PAtm.



Note: With Current Measurement as the Instrument's Output, the communication is available for the HART transmitter found in address 0 only.

Getting Default Mappings

On any of the instrument data pages, open the menu and tap **Get Mapped Values**. Then MC6-WS starts reading data from the connected instrument to MC6-WS's Identification and Device fields, according to **Mapping** settings.

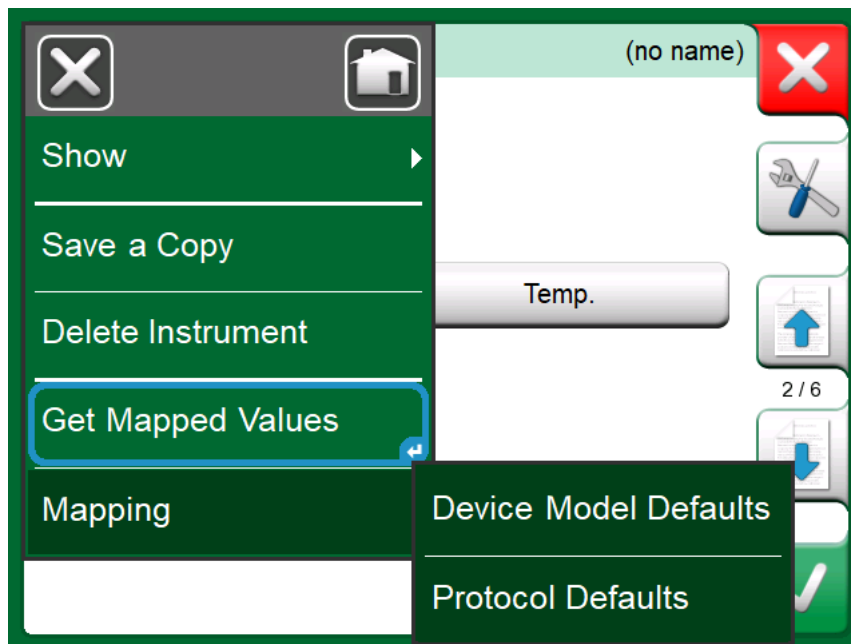

Figure 76: Mapping menus on instrument pages

That's all you need to do, provided the mappings suit your needs. If not, see chapter [Customizing the Mappings](#).

However, you should anyhow always check all the instrument settings after the data is read, before continuing with your work.



Note: For HART[®] Instrument's, the input setting is also read from the transmitter. For other instruments, you need to manually add the Instrument's input data.

Customizing the Mappings

The menu option, **Mapping**, has in its submenus options on how to define general mappings on protocol level (**HART[®]**, **FOUNDATION Fieldbus H1** or **Profibus PA**) and also default mappings on device model level.

MC6-WS uses the **Protocol Defaults** if no default mappings are defined for the connected device model. If **Device Model Defaults** exist for the connected device model, they are used instead of **Protocol Defaults**.

In the [Figure 77: Sample of default mappings for HART[®] protocol](#) you can see a sample of the mappings. The left side lists the fields in MC6-WS (target fields) and the Mapping Mode of the field (Generic in all cases of the sample picture). The right side lists the value and name of the field in the device.

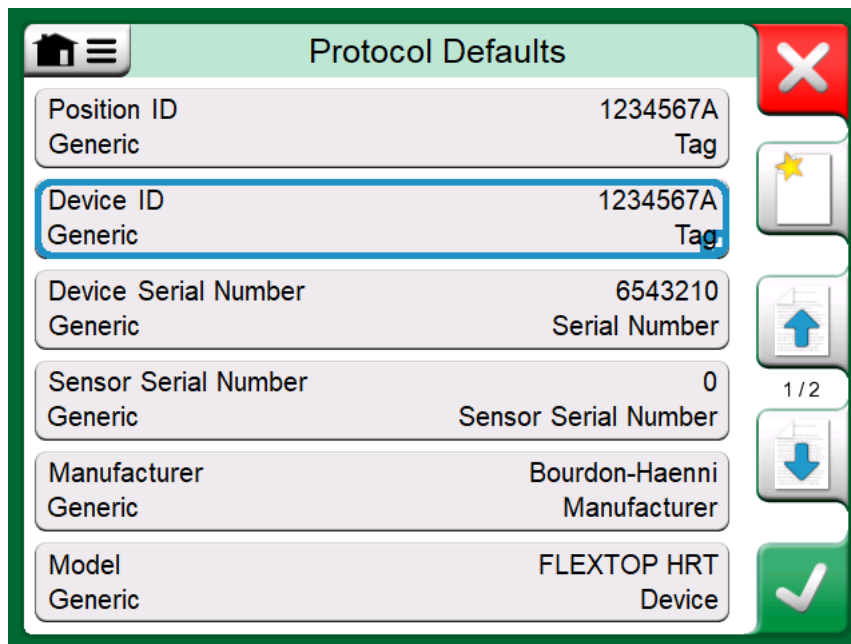

Figure 77: Sample of default mappings for HART[®] protocol

Tap on one of the buttons to edit the mapping. You may also add new mappings using the **New** button, the button with blank sheet and a star on its upper right corner. New mappings are defined similarly as existing mappings are edited.

Creating a new mapping or editing an existing mapping is done in a window like in the picture below.

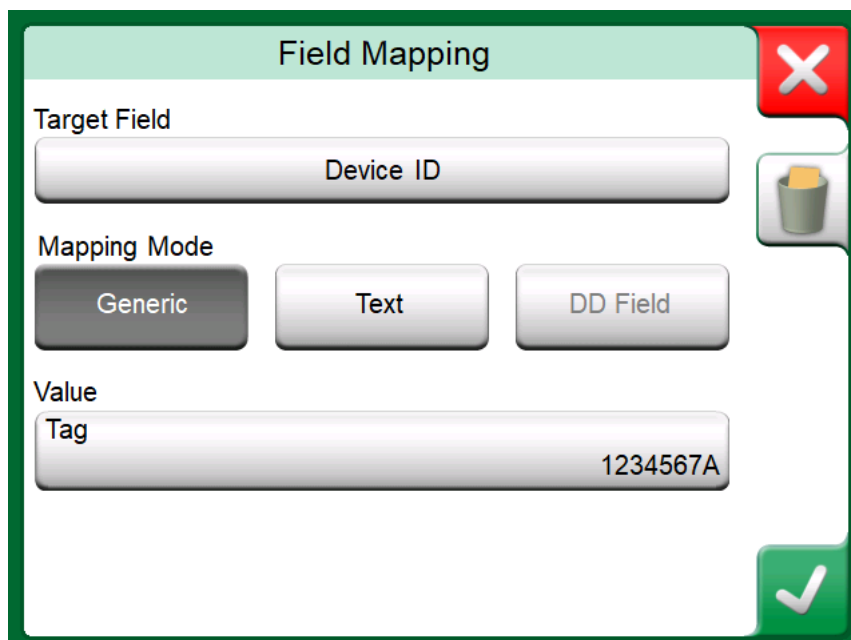

Figure 78: Sample of default mappings for HART[®] protocol

Target Field is the field in MC6-WS, **Value** is the field and its value in the connected device. Mapping Mode defines how the mapping is done.

- **Generic**, gives you a list of protocol's common fields.

- **Text**, assigns a fixed text to the selected MC6-WS field.
- **DD Field**, gives you a list of all fields etc. available in the device model's Device Description. Note that this option is not available for the **Protocol Defaults**, only for **Device Model Defaults**.



Note: It is possible to map the same transmitter field into several MC6-WS fields. In the [Figure 77: Sample of default mappings for HART® protocol](#), device's **Tag** is mapped both to **Position ID** and **Device ID** in MC6-WS's instrument data.

When adding or editing mapping, the target fields that are already being used are disabled (gray).

When you change the mapping, it will be saved as the default mapping for future use.

After changing the mapping, you need to read the data again using the **Get Mapped Data** menu command.

You can remove a single mapping line by opening it and touching the "Trash Can" icon.

Value	
Message	Tag
Range	-100...300(32)
Device ID Number	1014407
Tag (short)	ES22
Tag (long)	Elegant Stealth 22
Sensor Serial Number	32752A098

Figure 79: Generic Fields when Mapping Mode is "Generic"

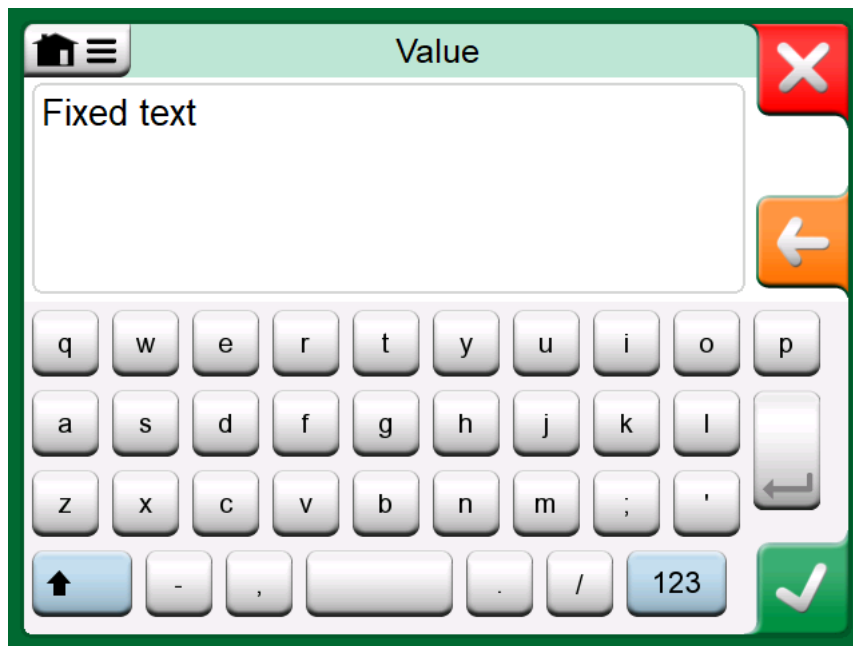

Figure 80: Text editing when Mapping Mode is "Text"

Part 6, Data Logger

Things discussed in this part:

- An introduction Data Logger option and its capabilities
- How to configure and start a Data Log
- How to view, save and delete Data Log results
- How to transfer Data Log results to a personal computer (PC).

General

The **Data Logger** is an optional tool that allows you to collect data with MC6-WS. If the Data Logger option is purchased, the collected data may then be viewed, transferred to a personal computer (PC) and printed using a utility called **Beamex MC6 Data Log Viewer**. It is available for download at Beamex's website: <https://www.beamex.com>.

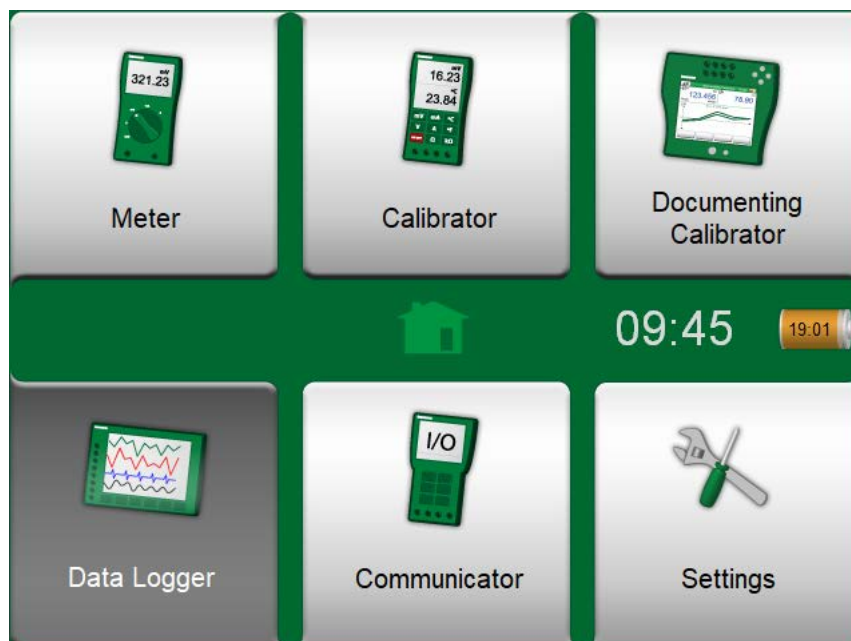

Figure 81: Home View with Data Logger selected

If your MC6-WS does not have the option installed, the **Data Logger** icon in MC6-WS's Home View is disabled.

If applicable, open the main configuration window of the Data Logger by tapping on the **Data Logger** icon in MC6-WS's Home View (see the picture below).

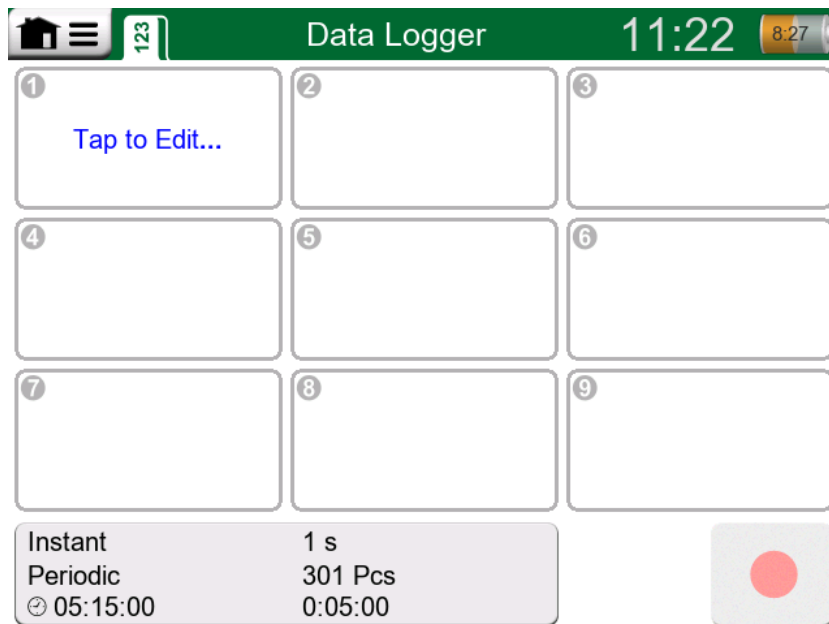

Figure 82: Main configuration window when no data log channels have been configured

Data Logger supports logging up to nine measurement/generation/simulation channels at the same time. However, the amount of available measurements/generations/simulations depends on how your MC6-WS is equipped.

Typically, you see some previously configured channels, since MC6-WS remembers the latest data log configurations.

Doing a Data Log

Configuring

In the main configuration window: Tap on one of the numbered areas to configure a channel.

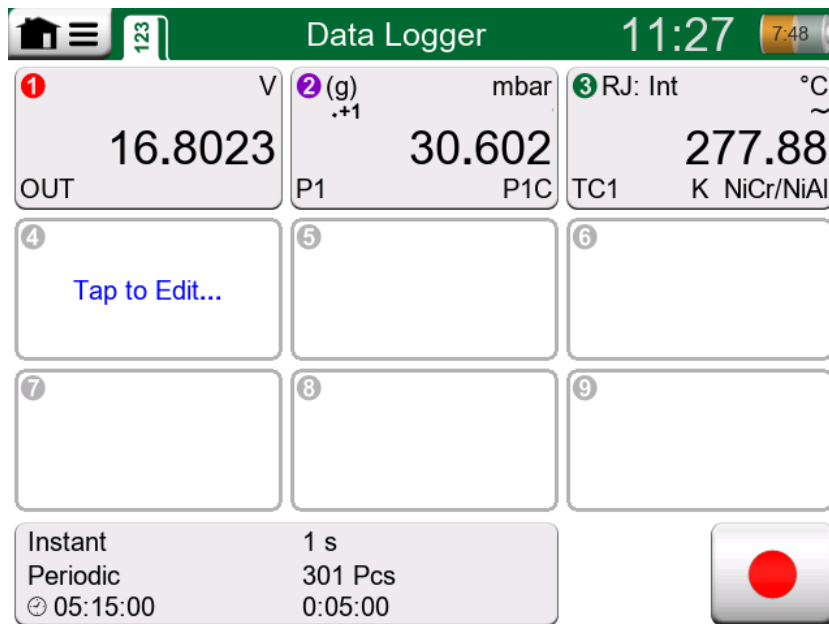

Figure 83: Three configured channels in main configuration window

Each channel have individual configuration pages as follows:

- A page for defining the measured/generated/simulated quantity and its additional settings.
- Another for defining the range of the graph, giving the measurement/generation/simulation a descriptive name (optional) and selecting plot color.
- A third page is available for measurement channels only: You may define a trigger that invokes the Data Log. When triggering is configured, a symbol indicates it. See [Figure 83: Three configured channels in main configuration window](#).

Remember to check/edit the general settings of your Data Log. Tap on the area in the lower left corner of Data Logger's main configuration window. There you may, among other things, define how the logging is performed, what value is saved and the duration of the logging.



Note: For pressure measurements:

The main configuration window's menu includes a possibility to zero gauge pressure modules. Zeroing is also possible in channel setup windows (when applicable).

Saving and Opening Configurations

In addition to MC6-WS remembering the latest Data Log configurations, you may save useful configurations for future use. Saving and opening previously saved configurations is available in the menu of Data Logger's main configuration window.

Starting the Data Log

Start the Data Log by tapping on the red "**Record**" button in the main configuration window's lower right corner. The button changes to a black "**Stop**" button allowing you to interrupt you Data Log, when necessary.

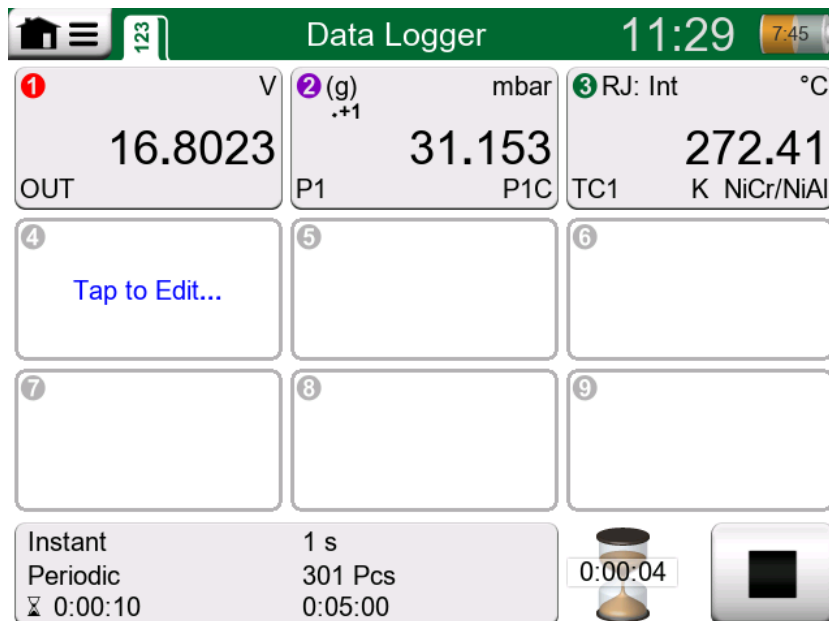

Figure 84: Counting down the delay

The actual start of Data Logging depend on general settings as follows:

- If you have defined a delay in the **Delayed Start** field, an hour glass with a down counter appears for as long as the delay requires. The delay may be either a defined wait time, e.g. 5 minutes, or a specific time of the day, e.g. 5:15 PM.
- If your **Logging Method** is "**Key Press**", a camera button appears for you to take "snap shots" of the measurements.

When the possible delay defined in general settings has expired, possible triggers defined for individual channels delay the start of the Data Logging. Any channel that trigs, starts the Data Log.

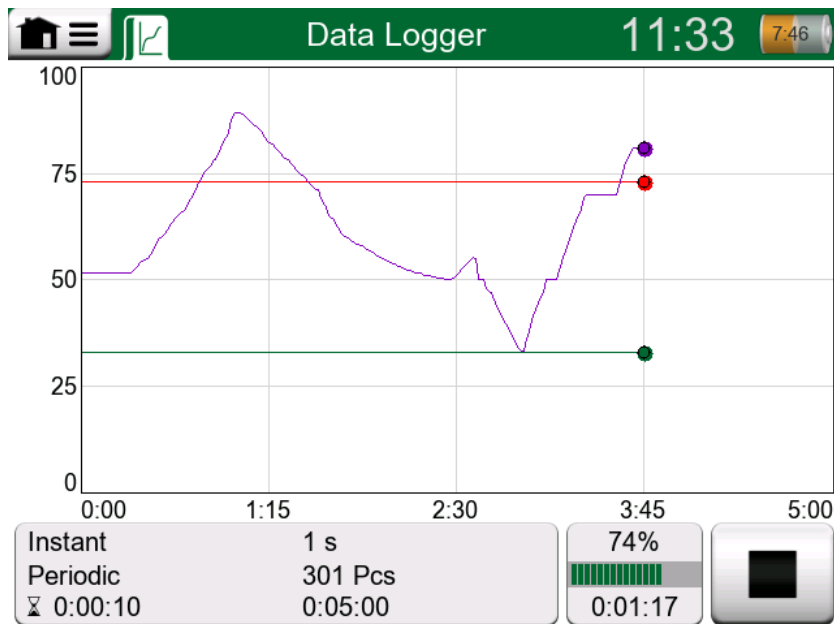

Figure 85: Graph view during Data Log

You may change the view from the main configuration window to the graph view and back, using the button to the left of the Record/Stop button.



Note: If, in general settings, the **Logging Method** is "Key Press", none of possible triggers defined for individual channels are valid. The snap shot is saved immediately each time the snap shot button is tapped on.



Figure 86: Snap shot button

A generation/simulation value may be changed during the data log as follows:

In the main configuration window, tap on the channel where a generation/simulation is configured. In the opened window, locate the output value field and tap on it to edit the numeric value.

Viewing and Saving or Deleting the Results

When Data Logging is finished, or stopped, the results are shown on three pages: general information page, graph page and a table of numeric results. If the table of numeric results is large, use the scroll buttons or the scroll bar to see hidden rows/columns.

Results Preview			
Time	OUT (V)	P1 (mbar)	TC1 (°C)
11-07-2022 11:29:40	Instant	Instant	Instant
11:30:01	16.8023	51.374	272.73
11:30:02	16.8023	68.221~	272.60
11:30:03	16.8023	85.849~	272.59
11:30:04	16.8023	91.504~	272.47
11:30:05	16.8023	98.439~	272.47
11:30:06	16.8023	105.880~	272.41
11:30:07	16.8023	123.545~	272.36
11:30:08	16.8023	148.025~	272.41
11:30:09	16.8023	172.903~	272.34

Figure 87: Results Preview

All pages include a possibility to either save or delete the Data Logging results. When saving, you have the possibility to give a descriptive name to the Data Logging results. MC6-WS automatically adds date and time to the Data Logging results.

Viewing Saved Data Log Results

If you have saved Data Logs, they may be viewed as follows:

- From the menu of the Data Logging's main configuration window. Select menu option **View Data Log Results**.

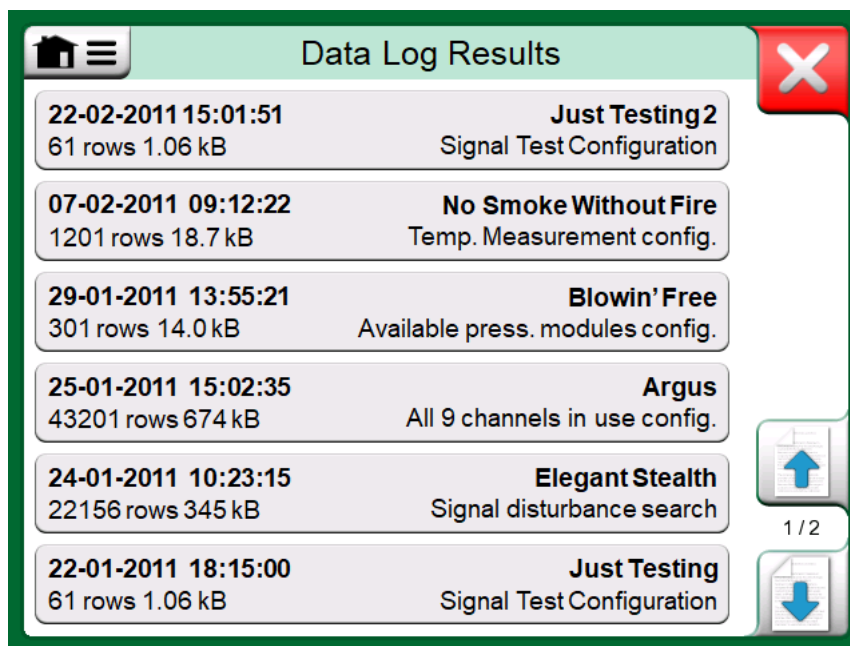

Figure 88: Data Log Result list

Each saved Data Log result has the time/date it was saved and the entered result name on the first row in bold font. On the second row you can see information of Data Log's size and possibly the name of the configuration used for doing the Data Log.



Note: When viewing the list of saved Data Log results, the menu includes the possibility to **Delete All** saved Data Log results. If you select one of the existing results for viewing, the menu includes a possibility to either **Delete** or **Rename** the viewed Data Log results.

Transferring Data Log Results to a Personal Computer

Beamex MC6 Data Log Viewer (executable file: "MC6DataLogViewer.exe") reads data log results to a Personal Computer. The software works in any 32 bit or 64 bit Windows® 7 ... Windows® 10 operating system. Installation software for Beamex MC6-WS Data Log Viewer is downloadable from Beamex's website <https://www.beamex.com>. Look for **Download Center**.

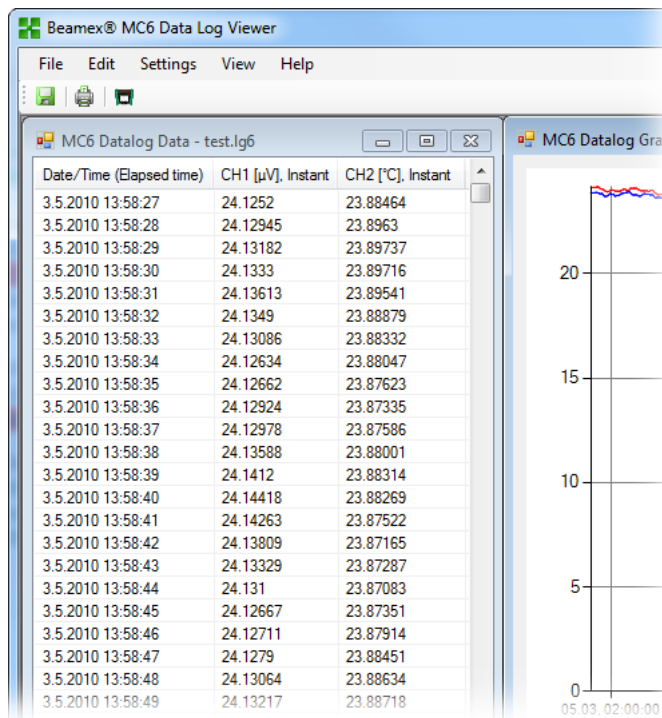

Figure 89: Screenshot of Beamex MC6 Data Log Viewer

Before you read data from MC6-WS, you must connect the MC6-WS to your PC using the USB cable provided. Then install the driver as presented in [Part 1, Introduction](#), chapter [USB Communication Driver](#).

After the driver is installed, the software can be used for downloading the results from MC6-WS and viewing the results. The data can be saved in viewer's native format (.LG6) or saved as **CSV** files. The latter format can easily be imported into spreadsheet software.

Part 7, Communicator

Things discussed in this part:

- An introduction MC6-WS's Communicator and how it can be started
- How to connect to an instrument capable of digital communication
- Instructions on how to quickly select a variable/parameter for use in Calibrator, Documenting Calibrator or Data Logger
- How to edit instrument parameters
- About how to trim a Fieldbus/HART instrument.

General

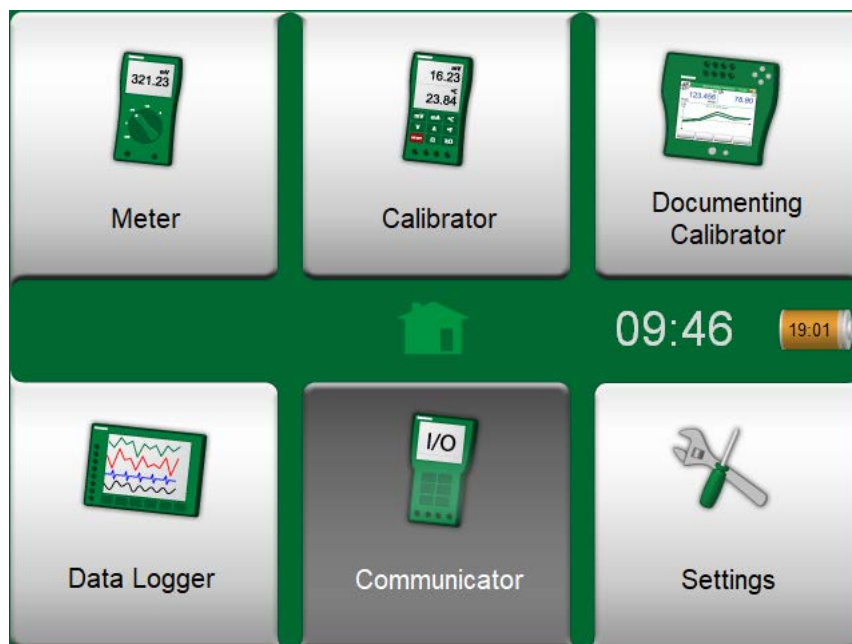

Figure 90: Home View with Communicator selected

MC6-WS's **Communicator** option allows you to connect to the following Instruments utilizing Digital Communication:

- **HART**[®] instruments (*
(<https://www.fieldcommgroup.org/>)
MC6-WS can be used as a primary or secondary master of a segment.
- **FOUNDATION Fieldbus H1**[™] instruments
(<http://www.fieldbus.org/>)
MC6-WS is seen as a guest device (visitor) and, when necessary, as a Link Active Scheduler (LAS, segment's master device).

- **PROFIBUS PAtm** Instruments

(<https://www.profibus.com/>)

MC6-WS takes the role of PROFIBUS Master when connected to a PROFIBUS segment.

When **Communicator** is started, a list of communication protocols available for MC6-WS is shown. See the picture below.

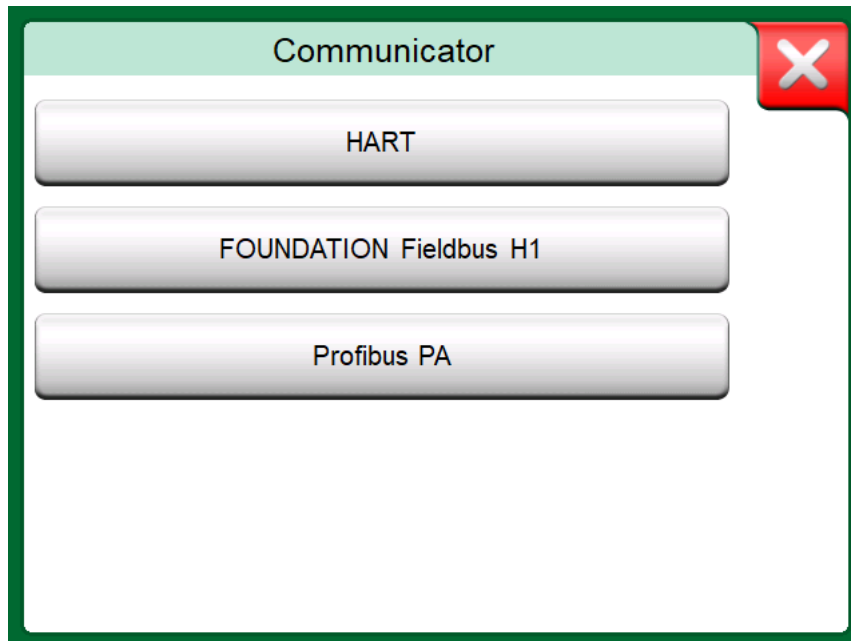

Figure 91: Communication protocols



Note: Each communication protocol is a separate option in MC6-WS, so all protocols are not necessary enabled in your MC6-WS.

This manual is not an introduction to HART and Fieldbus instruments. Get the know-how and terminology from books dedicated to HART and Fieldbus instruments and technology.

The Communicator's user interface may include text in another language than what MC6-WS's user interface language setting is. This happens when the language of the instrument's fields etc. differ from MC6-WS's.

**) MC6-WS supports HART instruments using HART Protocols 5, 6 and 7.*

Communication may also be started from the following main functions in MC6-WS:

- **Calibrator,**
- **Documenting Calibrator and**
- **Data Logger**

Depending on active/inactive options, some communication protocols may be disabled (grayed).

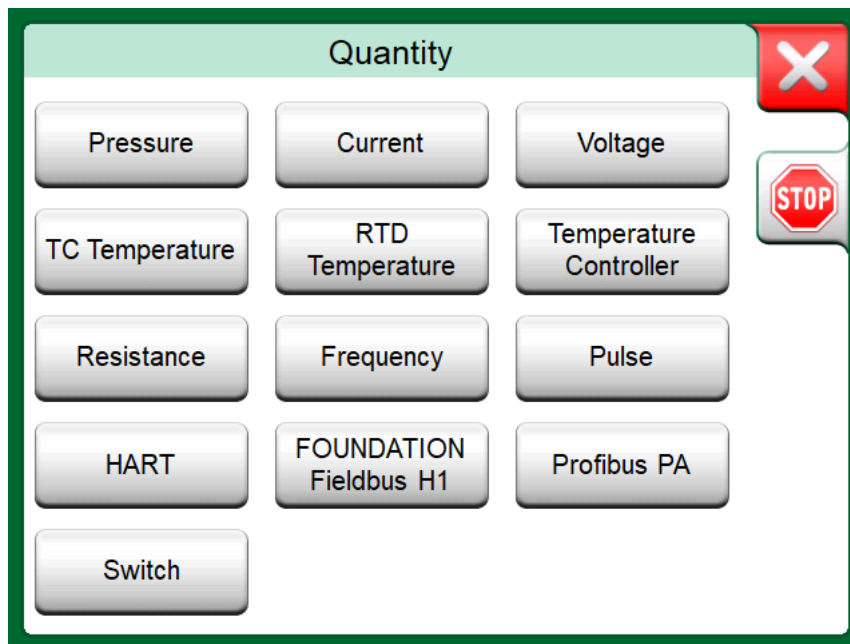

Figure 92: Selecting a communication protocol in Calibrator, Documenting Calibrator and Data Logger

MC6-WS's **Communicator** is primarily meant for viewing and editing the configuration of Digital Communication Instruments. However, when invoking communication from **Calibrator**, **Documenting Calibrator** or **Data Logger**, you most likely plan to **select a Variable or Parameter** (e.g. Primary Value) for calibration or data logging instead of doing full configuration for the instrument. MC6-WS, of course, supports this functionality too.

See also chapter [HART Device Description Specifics](#).

Warnings



Warning: Configuring/calibrating an instrument that is part of a live segment is possible in HART and FOUNDATION Fieldbus only. When working in a live segment, first make sure, the control loop the instrument is part of is set to manual. Follow the guidelines available in the instrument's own manual.

Beamex cannot be held responsible for any damages caused by connecting MC6-WS to a live factory fieldbus segment.



Warning: Using MC6-WS to change the parameters of an instrument may result in discrepancies: A fieldbus host control system may mirror all instrument parameters in its permanent database. In such a case, when returning an instrument with changed parameters to a live segment, ensure that the parameters are also available in the control system's permanent database. Also verify that the new parameters do not result in an unstable control loop.

Connections

When communicating with Digital Communication Instruments, the connection differs depending on whether MC6-WS's internal power supply is used or not.

The [Figure 93: Using MC6-WS's internal power supply](#) presents the connections when **MC6-WS's internal power supply is used**. MC6-WS's power supply can safely provide supply power to a single instrument. If connecting to a HART/fieldbus segment containing several instruments, consider using an external power supply as presented further on.

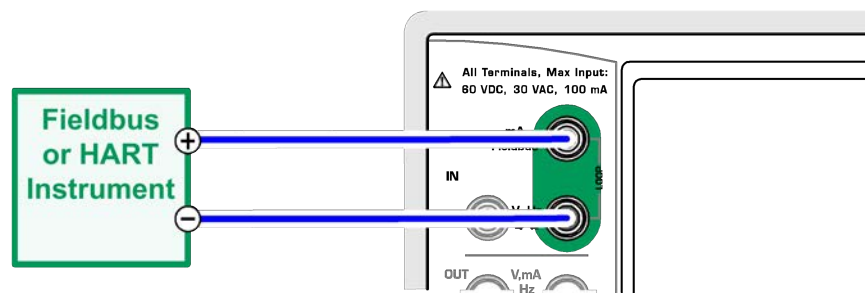

Figure 93: Using MC6-WS's internal power supply

The [Figure 94: Using an external power supply](#) presents the connections when **an external power supply is used**. Then, to ensure communication, there may be need to include an external resistor (250 ohm for HART and 50 ohm for fieldbuses). However, when using a fieldbus compliant power supply, there is no need for an external resistor.

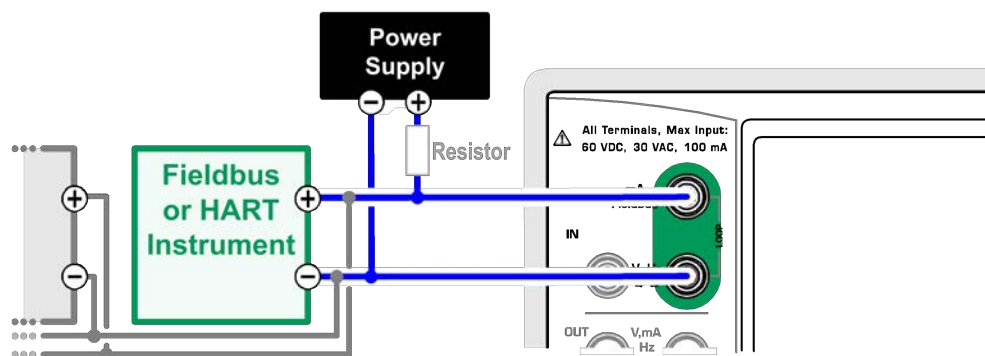

Figure 94: Using an external power supply



Note: The connection between MC6-WS and the instrument/fieldbus may be done using pair of standard measurement cables. However, when using longer connecting cables there may be need for fieldbus terminators.



Warning: When working in PROFIBUS PA: Do not connect two master devices (e.g. MC6-WS, a Field Communicator or a control system) at the same time to the same segment! They clash and make the fieldbus segment unstable. Remove the instrument to be calibrated from the live segment for calibration.

See also chapter [Warnings](#).

Selecting the Instrument

When a communication protocol is selected, a window opens for choosing **whether MC6-WS's internal 24 V supply is used or not**. When using an external supply, ensure communication by using either a Fieldbus/HART compliant power supply or add a suitable resistor between the power supply and the fieldbus. See chapter [Connections](#) and consult your power supply's manual.

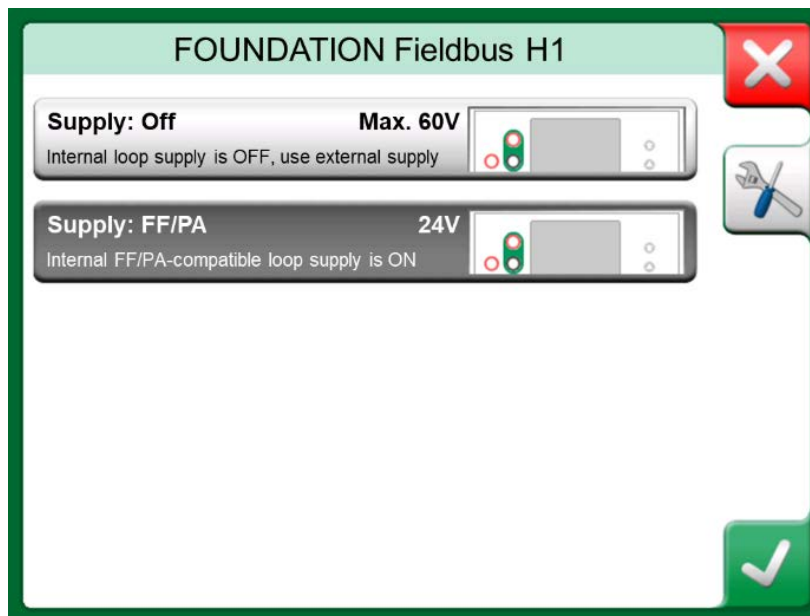

Figure 95: Supply voltage setting

There is also a button for editing/checking the **Protocol Settings**. The default settings should apply, so do not make changes unless you are sure. Consult the fieldbus instrument's manual, in case of communication problems.

List of Found Devices

When continuing, MC6-WS searches (monitors) for connected instruments and a window with a list of found devices opens. The window also includes a "refresh" button (two "rotating arrows") to retry the search for connected

instruments. The button with the cogwheels allows you to quickly edit the tag and address for the listed instruments. When edit mode is on, the button backgrounds change to blue.

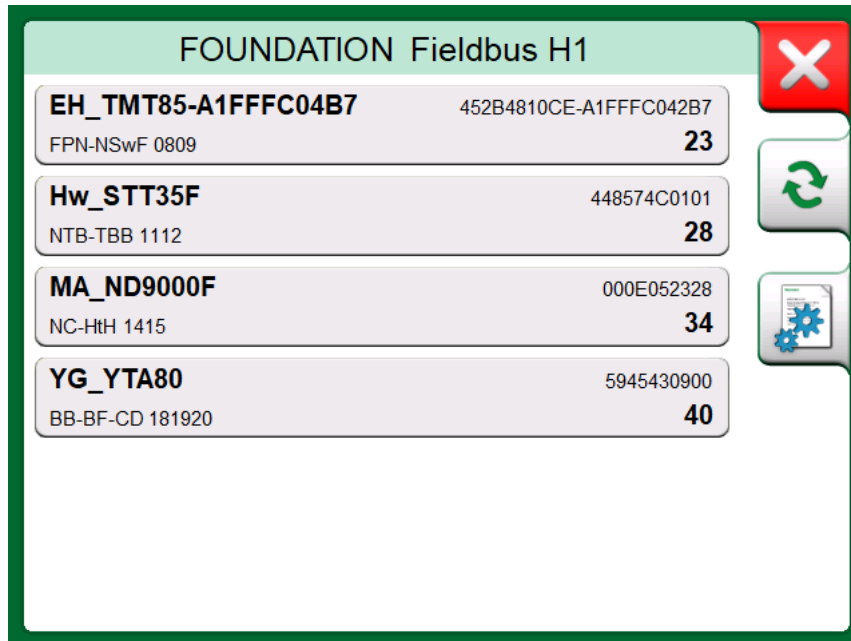

Figure 96: A list of found devices

When not editing tag and address, select the instrument for calibration by tapping on its name in the displayed list. Then MC6-WS uploads the instrument's data into its memory and when ready, displays it.



Note: If MC6-WS does not have the Device Description file for the selected instrument, a window opens informing you of the situation. Look for new Device Description files at Beamex's website: <https://www.beamex.com>. Install a downloaded Device Description file using the Device Description Installer software available at Beamex's website: <https://www.beamex.com>. Look for **Download Center**.



Warning: When the calibrator is monitoring a fieldbus/HART segment, DO NOT disconnect/reconnect the calibrator to/from the segment. The segment may become unstable.

About Instrument Parameters

Instrument Parameters in General

This chapter briefly presents how **Blocks**, **Records** and **Parameters** of Digital Communication Instruments are viewed in MC6-WS and how you may browse through them. Elements seen while viewing/configuring an instrument:

- **Blocks** and **Records** have yellow background where the upper right corner is folded. They may contain sub-blocks, sub-records, editable parameters and read-only parameters. Tap on the block/record to see its contents.
- Different types of **Parameters**:
 - **Editable Parameters** have gray background. They may be numeric, text, single select, multi select or date fields. Tap to edit the field data.
 - **Read-Only Parameters** are data that you may view/read but they cannot be edited. They have gray background with a "lock" in the upper right corner.
 - **Value Parameter** is actually a special case of the Read-Only Parameter. The value is a result of a measurement and cannot be edited, but it can be opened for viewing and selected for use in the **Calibrator**, **Documenting Calibrator** or **Data Logger**. Value Parameters have green background. See also note to the right and hint below
 - **Methods** look like parameters, but are actually automated procedures for e.g. calibration in HART instruments. For details, see instrument's user manual.

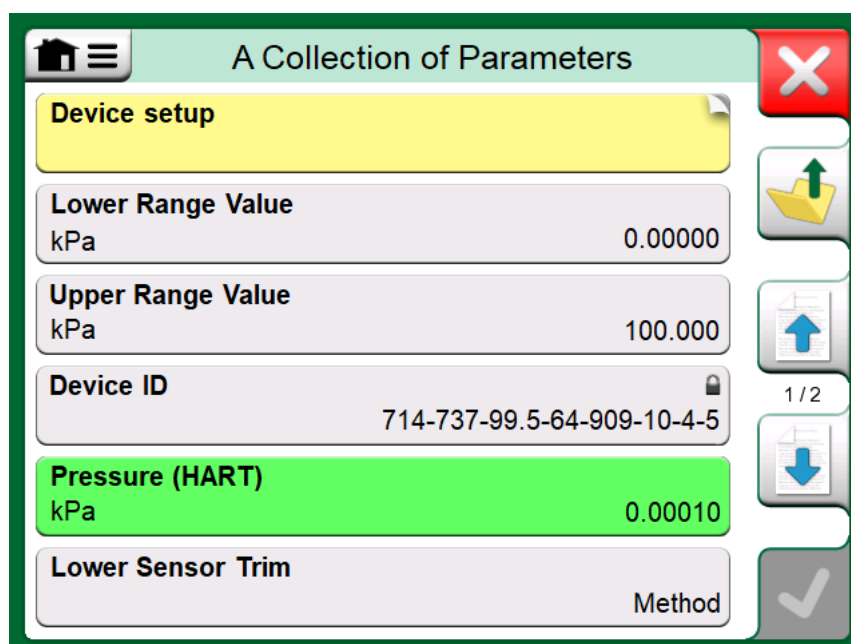

Figure 97: Blocks and Parameters, an example view



Note: Since value parameters are often of high interest, the menu contains a possibility to view value parameters (measurable variables) only.



Note: If you select a Value Parameter and you started communication from the **Communicator**, the value is taken into use in **Calibrator**. If communication is started from any other supported main function, e.g. **Data Logger**, the chosen Value Parameter is taken into use in that particular main function.

Calibrating or Data Logging HART Instruments

Usually, when calibrating or logging, you need to locate a **Value Parameter**, a Process Variable, in the HART instrument's instrument data. Remember that Value Parameters have green background.

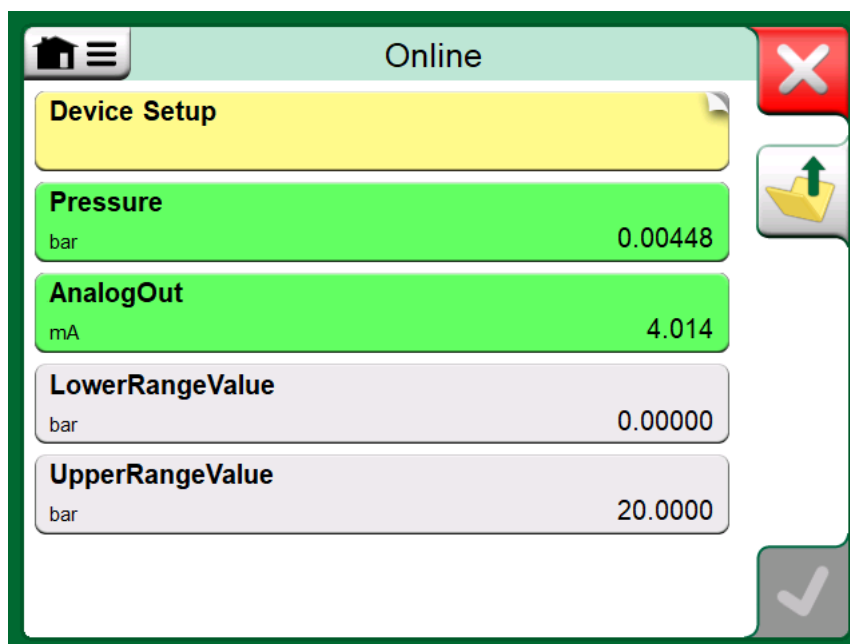

Figure 98: Example of a variable list in a HART Transmitter

Unfortunately the structure of data and naming conventions in HART instruments vary between different makes and models. Thus there is no single path from selecting the instrument in MC6-WS to locating the parameter. Refer to your instrument's manual to find the blocks where the parameters are located.

Once the parameter is located, tap on it. In the opened window: Tap the **Accept** button to start calibrating or logging that parameter.

Calibrating or Data Logging Fieldbus Instruments

This is a quick guide for selecting a **FOUNDATION Fieldbus** or **Profibus PA instrument's Parameter** for calibration/data logging. If you want to make more extensive configurations, refer to chapter [About Instrument Parameters](#) and the manual of your instrument at hand.

1. First you must select either **FOUNDATION Fieldbus** or **Profibus PA** as your communication protocol and select the instrument as presented in chapter [Selecting the Instrument](#).
2. **Transducer** is the typical name of the **Block** (folder) where measurement parameters are located. When applicable, tap on it. Note that the **Block** name depends on the instrument, so when uncertain, refer to your instrument's user manual.
3. Browse the opened list of blocks, records and parameters. Tap the one you select for use in MC6-WS, e.g. **Primary Value**.
4. Accept the selection by tapping on the **Accept** button.

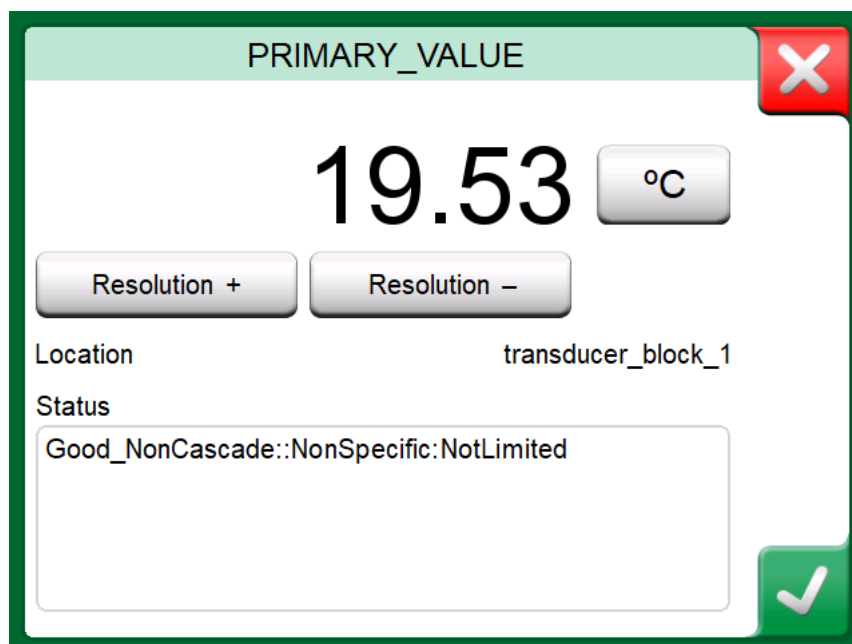

Figure 99: Accepting a parameter

Editing Parameters

With "editing parameters" we mean changing any editable parameter in the instrument's memory, e.g. selecting the type of process connection fitted to the instrument.

Editing a Parameter is started by tapping on it. A window opens for editing the data. The type of window depends on the type of parameter that is edited, e.g. a selection list, text or a numeric value.

When editing a stand-alone parameter (stand-alone in this context means it is not part of a record that contains several parameters), the edited value is sent to the instrument immediately when the accept button is tapped on.

In a **HART** instrument: If a parameter is part of a **record**, i.e. several parameters together as in the example [Figure 100: Example of a record: Sensor Information](#), each parameter may be edited separately. However, the edited values are not sent to the instrument until the accept button of the record window is tapped on. Prior to sending, edited parameters have a blue background.

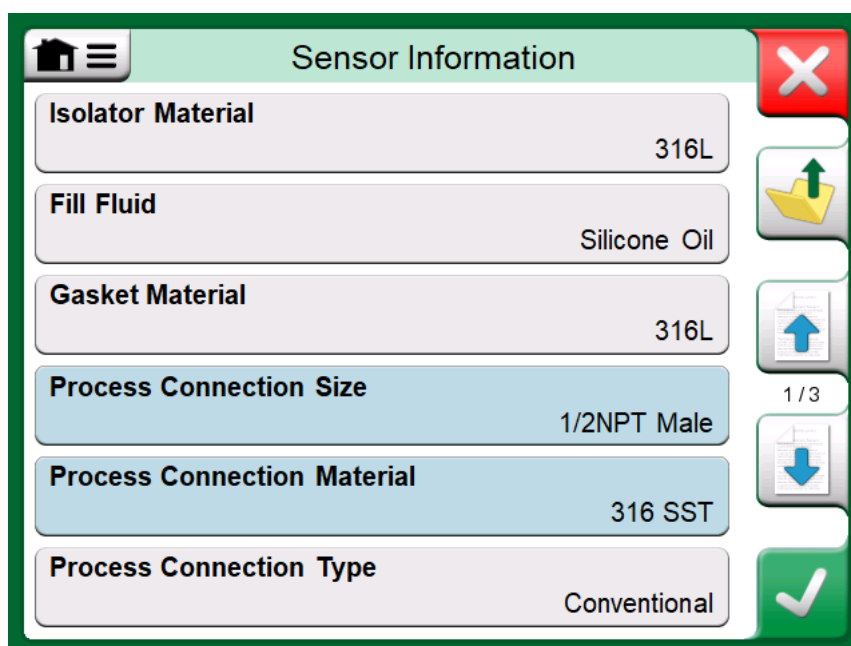

Figure 100: Example of a record: Sensor Information

See also chapter [Warnings](#).



Note: This manual explains how the parameters are accessed using MC6-WS. For detailed information of instrument data, refer to the manual of the instrument itself.

Beamex cannot be held responsible for any damages caused by changing instrument parameters.

Trimming a Fieldbus Instrument

Trimming a **FOUNDATION Fieldbus** or a **Profibus PA** instrument can be initiated from the **Documenting Calibrator**, provided the relevant communicator option is enabled and the instrument's Device Description contains information of parameters needed for trimming.

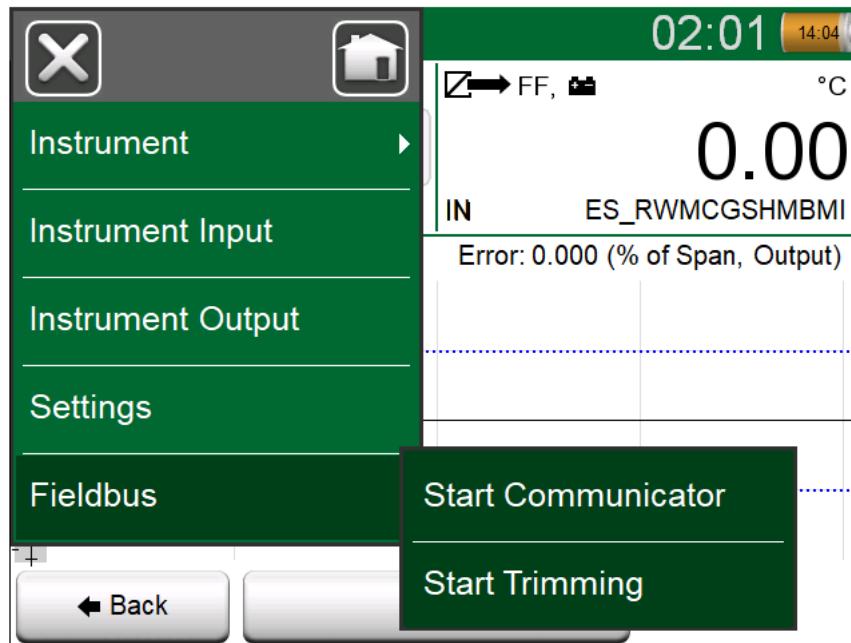

Figure 101: Menu in Documenting Calibrator when calibrating a fieldbus instrument

Menu option **Start Trimming** opens a window similar to the [Figure 102: Fieldbus instrument's trimming window, example](#). The list of Blocks and Parameters depends on instrument's Device Description. The lower part of the window has areas where the instrument's input (1) and output (2) readings are shown.

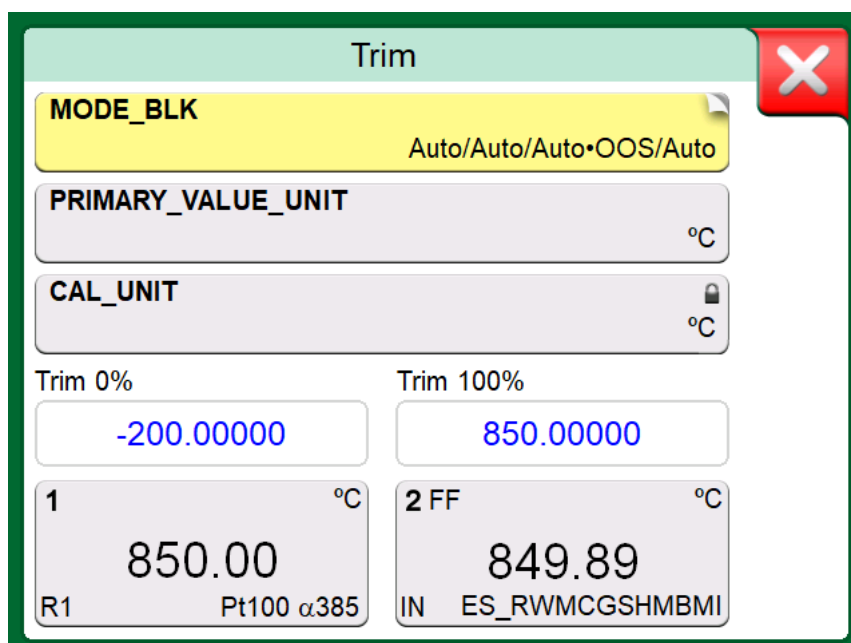

Figure 102: Fieldbus instrument's trimming window, example

Refer to the instrument's user manual for detailed information on how the trim procedure progresses. Usually you first set the **Mode Block** to Manual and then start editing the other data.

The actual trim is done by tapping on **Trim 0 %** or **Trim 100 %** values after a valid input signal is generated/simulated/measured. A window for editing the numeric value opens. The window includes a button for copying the input reading as the correct value.



Figure 103: Copy button



Note: Some fieldbus instrument manuals and user interfaces use the term "calibration" when they actually mean a trimming procedure. Be aware of this pitfall when trimming a fieldbus instrument.

Be careful during the trimming procedure. Follow the instructions in the instrument's user manual. Skipping a step in the procedure may result in an unsuccessful trim.

Trimming a HART Instrument

Trimming a **HART** instrument can be started from the **Documenting Calibrator's** menu and also from other MC6-WS's main functions where HART communication may be started. When calibrating a HART instrument, the Documenting Calibrator's menu contains the option **HART Communicator**.

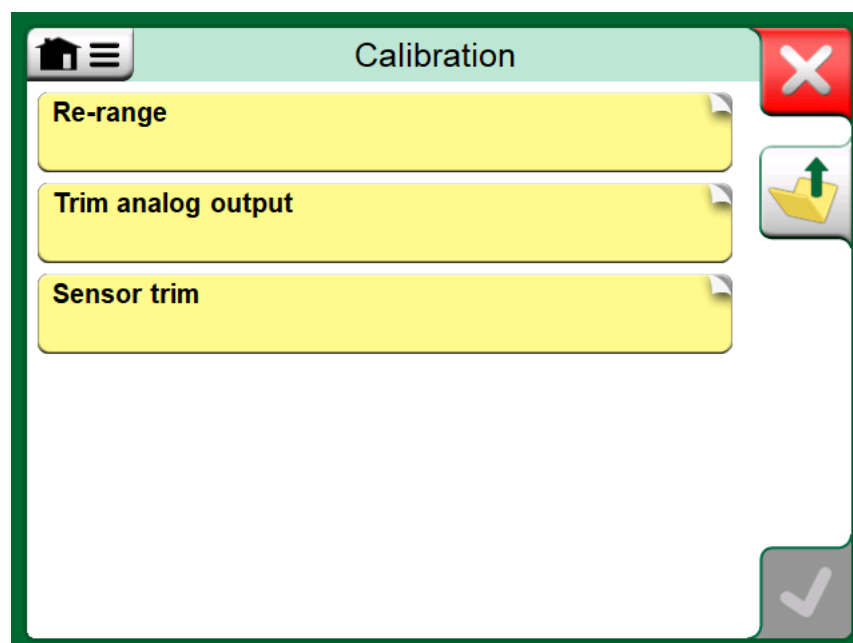

Figure 104: Sensor trim method

When trimming, refer to the instrument's user manual to locate and start a trimming method, either for the analog or the digital signal/sensor. When the

method is located follow its instructions. At some point during the method, you need to apply an applicable input signal. See [Figure 105: Trim method in progress](#).

- If the trimming procedure was invoked from Documenting Calibrator, the lower part of the window has areas where the instrument's input (1) and possibly also the output (2) readings are shown. Use the input signal area to check what the correct reading is.
- If the trimming procedure was invoked from another MC6-WS main function, e.g. Communicator, tap on either of the areas reserved for calibrator readings and select a suitable Quantity for measurement.

In both cases: When the input signal is as required, enter the correct value to the numeric field that is made available at this stage. Optionally, use one of the **Copy** buttons seen on the right side of the window to copy the reading available in the areas reserved for calibrator readings.

To finalize the trim, continue as the trim method describes on MC6-WS's display.

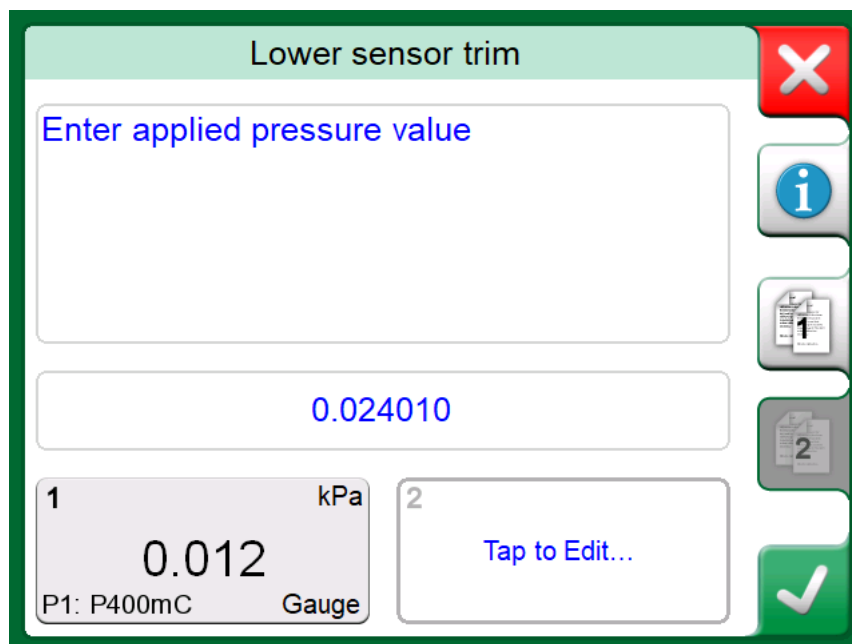

Figure 105: Trim method in progress



Note: Just as in fieldbus instruments, the user interface and manuals of HART instruments are sometimes using the misleading term "calibration" although it is actually a trim that is performed.

Be careful during the trimming procedure. Follow the instructions in the instrument's user manual. Skipping a step in the procedure may result in an unsuccessful trim.

Typically, the correct order for trimming is: digital output first, then analog output.

HART Device Description Specifics

General

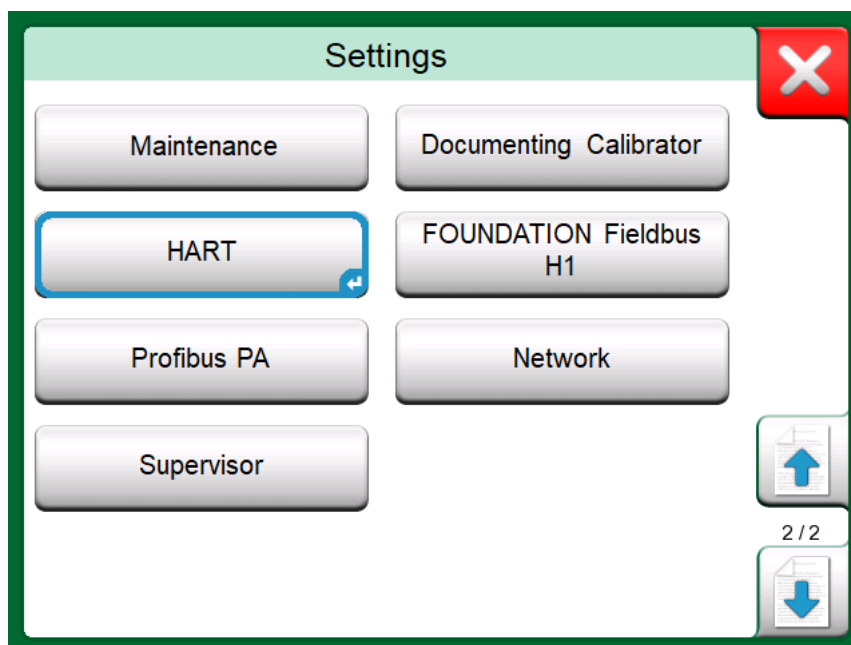

Figure 106: HART in MC6-WS's Settings

MC6-WS supports the use of three kinds of Device Descriptions for HART instruments:

- **Device Specific**, i.e. custom Device Descriptions for the HART device at hand, available in MC6-WS. Full instrument data is available.
- **Generic**, i.e. a library of common Device Descriptions applying to most HART devices. Only a standard set of instrument data is available for instruments containing additional, device specific data.
- **Basic View**, a simplified Device Description available in MC6-WS. It presents the instrument's value parameters only in addition to basic Device Setup and Process Variable Settings.

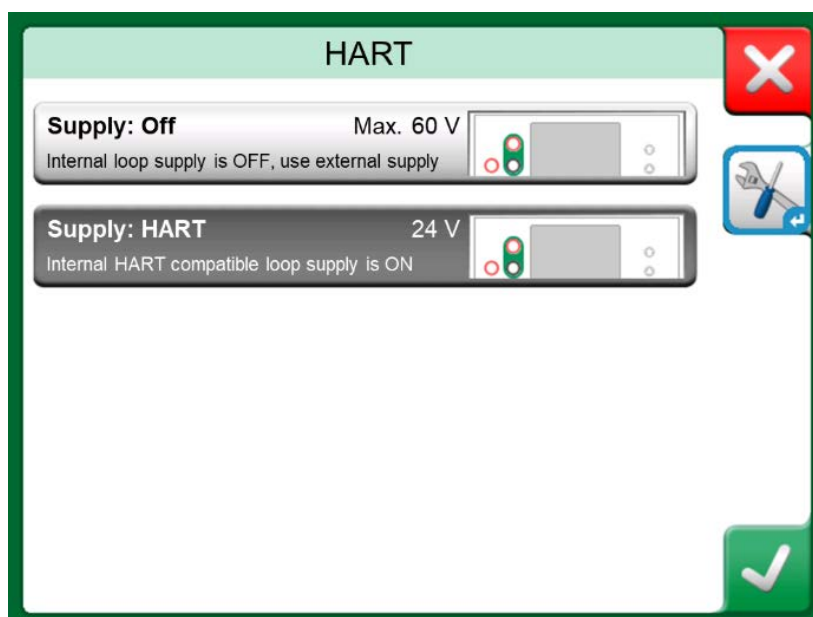

Figure 107: HART Tools elsewhere (note the Hardware Focus Indicator)

The default setting of Active Device Descriptions in MC6-WS may be defined in **MC6-WS's Settings**. Also: When connecting to a HART device and selecting the supply, the tools button on the right opens HART settings where you can select the Active Device Descriptions (see [Figure 107: HART Tools elsewhere \(note the Hardware Focus Indicator\)](#)). This is available in **Calibrator, Documenting Calibrator, Data Logger and Communicator**.

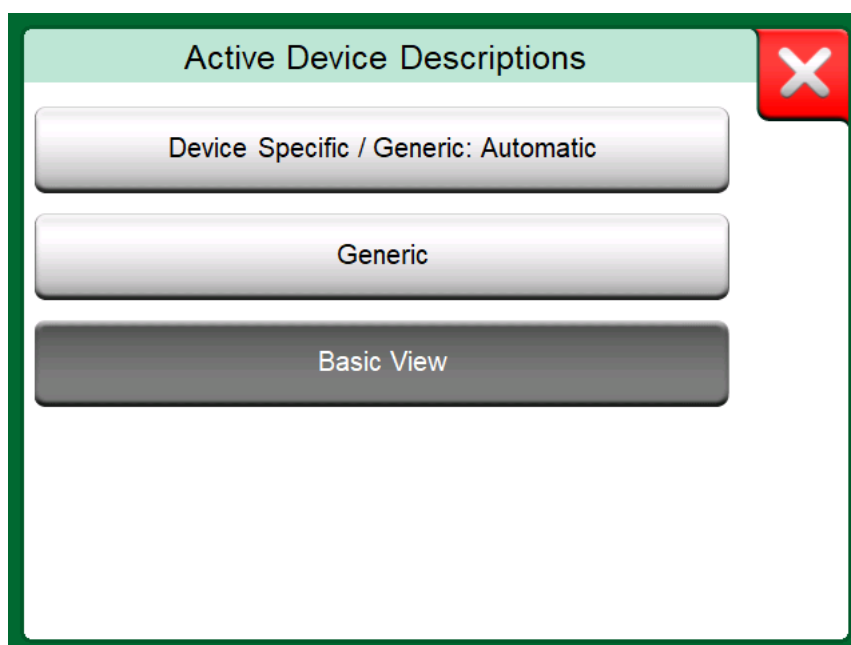

Figure 108: Window for Selecting a Device Description for Use

Basic View

MC6-WS's Basic View simplifies the use of HART instruments, since all that is seen are the instrument's value parameters in addition to basic Device Setup and Process Variable Settings. Select any value parameter you like for calibration, data logging etc.

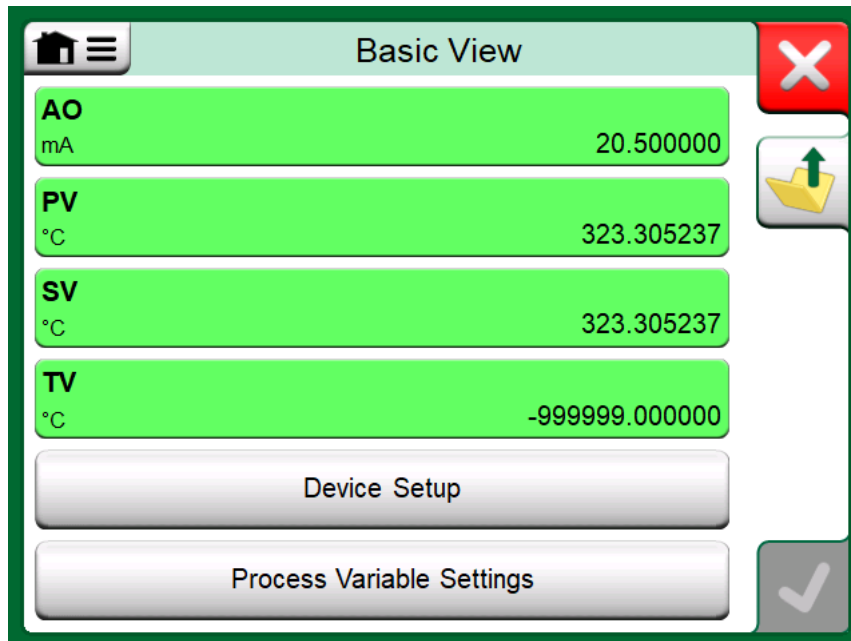

Figure 109: Example of HART Basic View

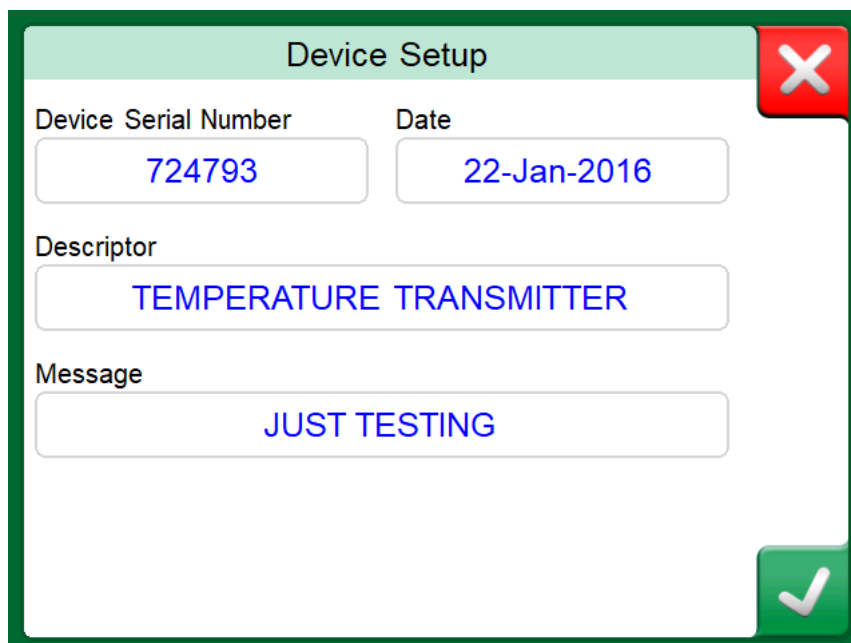

Figure 110: Example of a HART Device Setup Window

Figure 110: Example of a HART Device Setup Window and Figure 111: Example of a Process Variable Settings Window present fields that are available for editing in Device Setup window and Process Variable Settings window.

Process Variable Settings

Transfer Function
Linear

Unit: °C Damping (s): 0.4

Sensor Serial Number: 823097

Range: 0 (0%) ... 150 (100%)

Range Limits: -200 ... 850 / 10

Figure 111: Example of a Process Variable Settings Window



Note: HART trimming is not supported when using MC6-WS's Basic View. Use another Device Description when trimming a HART instrument.

Managing Smart Transmitter Configurations

General

Beamex offers a possibility to manage smart transmitter configurations using MC6-WS and a free tool for personal computers: **Beamex MC6-WS Fieldbus Configuration Viewer**. If applicable, the configurations may also be sent to **Beamex CMX Calibration Management Software**, as linked documents for a position.



Note: To be able to utilize this feature you need to have one or more of the necessary options installed (HART[®], FOUNDATION Fieldbus H1[™] or Profibus PA[™]).

Tools in MC6-WS

Saving Configurations

When connected to a smart transmitter, open the menu to locate the **Configuration, Save As** menu option. When selected, MC6-WS downloads all configuration data and after downloading it, prompts you to give the configuration a name. The default name is the transmitter's Tag name.

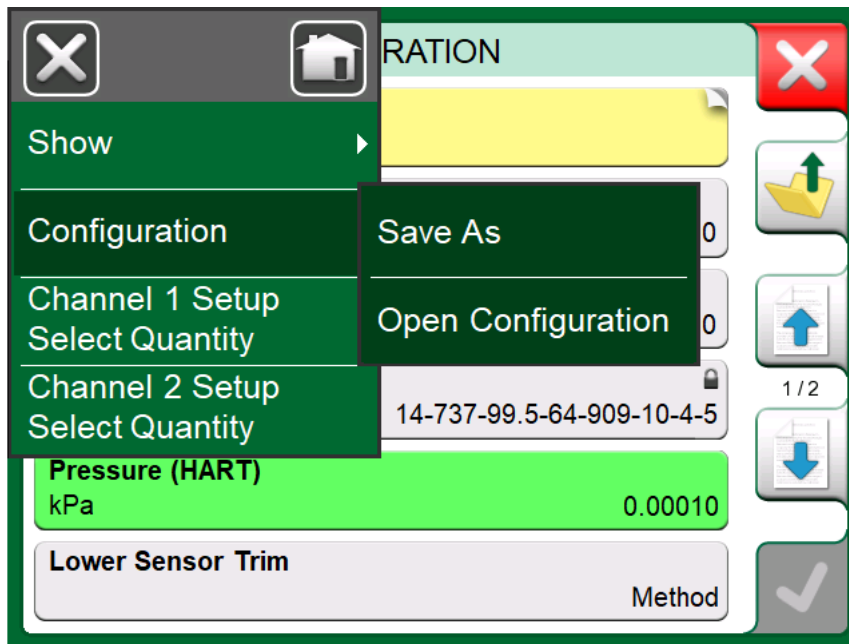

Figure 112: Configuration menu open

This feature is handy especially for customers that have analog DCS system and HART transmitters in the field. They can use this functionality to create a database with all the settings of their transmitters. If a transmitter breaks, all settings are stored in MC6-WS (alternatively on a PC's hard disk) for easy configuration of the new transmitter replacing the broken one.



Note: Please note that a saved configuration file cannot be written from MC6-WS back to a transmitter.

Viewing/Managing Configurations

Opening a list of saved configurations can be opened anywhere in **Communicator**. Open configurations option can be seen in the [Figure 112: Configuration menu open](#) and in the [Figure 113: Configuration options in protocol selection window](#) where no protocol is selected yet.

Selecting **Open Configuration** shows a list of saved configurations. The list shows the following information of each saved configuration file:

- The name of the file,
- Manufacturer / Model,
- Date / Time when saved and
- Protocol name.

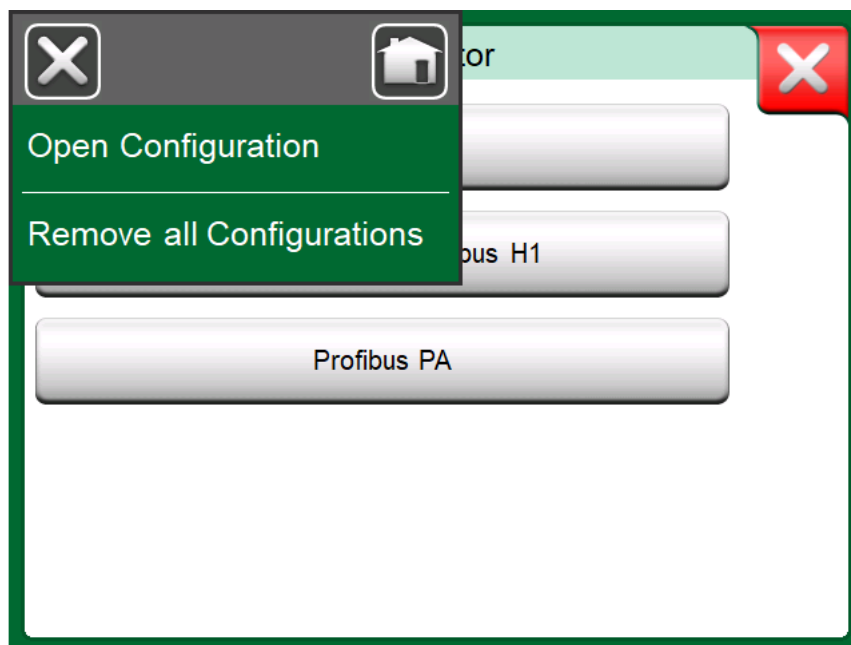

Figure 113: Configuration options in protocol selection window

You can sort the list of configurations according to your own needs with the help of the sorting tools available in the menu. Tap on a configuration to view the saved configuration data. Note that the data cannot be edited.

Beamex MC6 Fieldbus Configuration Viewer

Beamex MC6 Fieldbus Configuration Viewer is a free tool for personal computers with Windows[®] operating system. Download the Configuration Viewer software from Beamex's website: <https://www.beamex.com>. Look for **Download Center**.

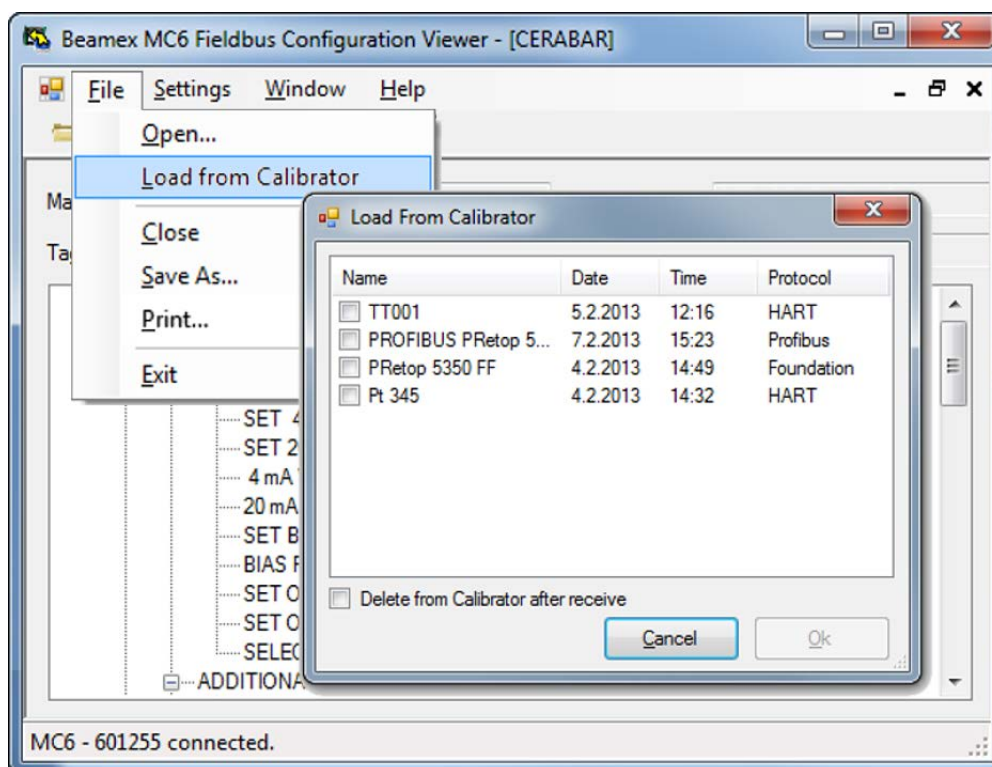

Figure 114: Beamex MC6 Fieldbus Configuration Viewer

Uploading Configurations

With **Beamex MC6 Fieldbus Configuration Viewer**, you can:

- Read configuration files from MC6
- View the configuration files
- Save the configuration files in PC (e.g. proprietary *.fc file).
- Print the configuration files

Linking Configurations to CMX

CMX includes a possibility to link documents to Positions/Devices etc. Use this feature to link the *.fc files to CMX. Double click the link to open it in the viewer.

Part 8, Settings

Things discussed in this part:

- How to configure MC6-WS to suit your own needs
- Briefly about recalibrating/adjusting MC6-WS
- Optional security tool.

Settings

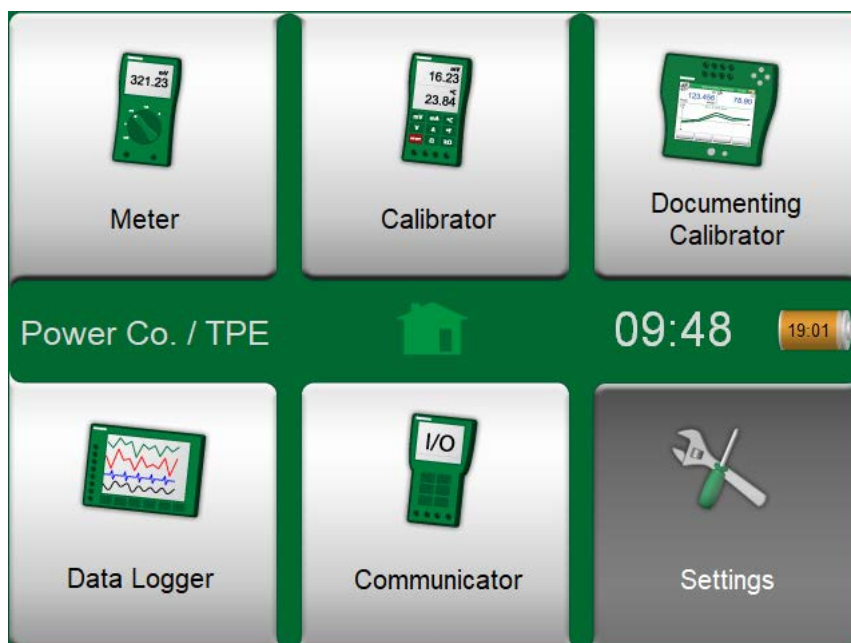

Figure 115: Home View with Settings selected and Owner information defined

This main function allows you to configure MC6-WS according to your own needs and also, recalibrate MC6-WS. The following settings/configurations are available:

- **Language** for selecting user interface language.
- **About**. Information about installed modules, firmware options etc.
- **Power Management** for defining auto-off delays and display brightness.
- **Sound Volumes** for setting volumes for different sounds MC6-WS emits.
- **Date & Time**, including Time Zone selection and activating Daylight Saving Time. See also chapter [Optional Security Tool](#).
- **Regional Settings** for setting local net frequency and default values. See also chapter [Optional Security Tool](#).
- **Owner** for entering owner information, shown in Home View.

- **Controller Presets.** Enabled if you have purchased controller communication options. More in [Part 9, Additional Information](#).
- **Maintenance** for recalibrating/adjusting MC6-WS and setting calibration date. Also, the possibility to align the Touch Screen. **Important:** Use a stylus when aligning the Touch Screen.
- **Documenting Calibrator.** Settings related to instrument calibration, e.g. is "Save as Both" allowed ("Save as Both" means a single calibration run may be saved both as As Found and As Left calibration.)
- **HART, FOUNDATION Fieldbus and Profibus PA** for defining communication parameters to Digital Communication Instruments.
- **Network** for setting local area network parameters. Future expansion.

Each setting/configuration is self-explanatory once you have familiarized yourself with MC6-WS's user interface. Configuration screens often have a menu option for recalling factory settings.



Note: MC6-WS's auto off functionality is disabled in the following cases:

- When charger is connected,
- when adjusting MC6-WS's own measurement/generation/simulation ranges,
- when a data log is in progress and
- when an instrument calibration is in progress.

PIN code for setting MC6-WS's calibration date is **2010**. PIN code for MC6-WS's adjustment is device dependent and was shipped together with MC6-WS.

Optional Security Tool

General

Beamex CMX Calibration Software version 2, revision 2.11 and later include an optional tool called **Mobile Security Plus**. It is a tool that enforces security related settings in mobile devices, including MC6-WS. For detailed information about Mobile Security Plus functionality, please see **CMX User Guide**.

Applied Restrictions

The following Documenting Calibrator functionalities are either restricted with admin credentials or blocked, depending on the setting in **CMX**:

- **Skipping** or **undoing** a calibration point,
- **Rejecting** (exiting) an incomplete calibration without saving the results,
- Changing the **calibration date and time** of a keyed calibration,

- **Deleting** calibration results and
- **Deleting** an instrument with calibration results.

Additionally, Changing Regional Settings, Date and Time require admin credentials.

Part 9, Additional Information

Things discussed in this part:

- How to create custom pressure units, PRT sensors and transfer functions
- Basic Information on how to connect external devices like pressure controllers or temperature blocks to MC6-WS.

Additional Information

This section contains detailed information of some of MC6-WS's more extensive features. The ones presented here are:

- [User Defined Pressure Units](#)
- [User Defined PRT/RTD Sensors](#)
- [User Defined Transfer Functions](#)
- [User Defined Steps/Calibration Points](#)
- [Controller Communication](#)

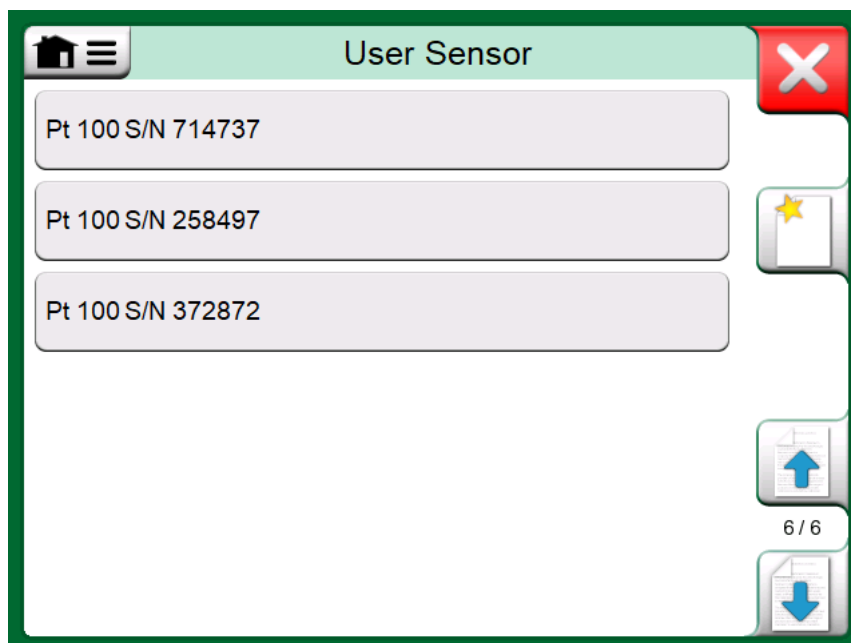

Figure 116: An example of a list of custom PRT sensors entered into MC6-WS

Pages, where new user defined items can be created, contain a button as seen in picture below. Add as many items as is needed; more pages are added when the previous page is full.



Figure 117: "Create New Instrument" button



Note: These features are meant for experienced calibration technicians familiar with calibrators, especially MC6-WS.

Deleting a user defined item stops a measurement/generation/simulation that was using it.

User Defined Pressure Units

Wherever in MC6-WS, when you use pressure as the **Quantity**, you may choose a pressure unit from a wealth of already available pressure units, divided into several pages. User defined pressure units may be added to the subsequent page(s).

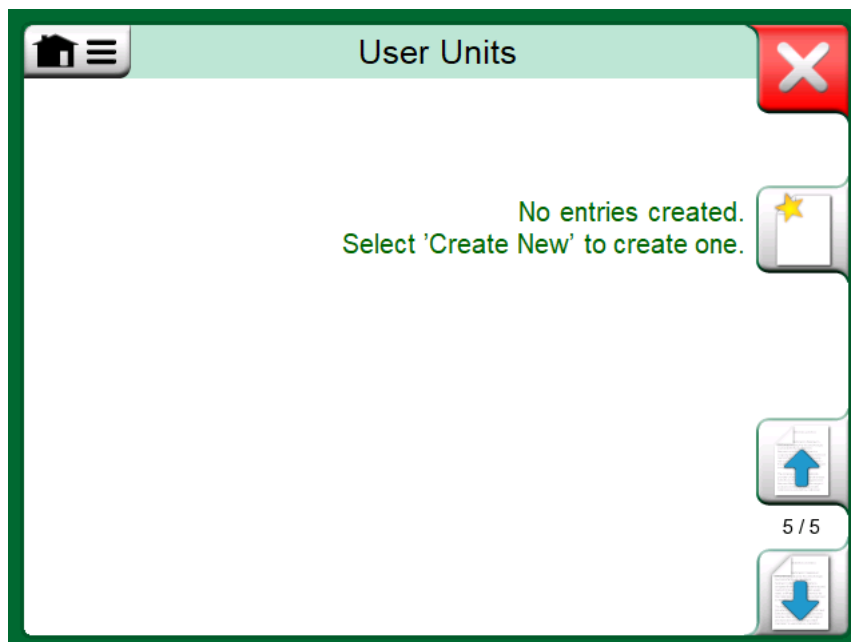

Figure 118: Page 5 of pressure units is reserved for user defined pressure units

In the configuration page, see [Figure 119: Configuration page](#), give the unit a descriptive name, select a **Reference Unit** and enter the **Factor**. The **Factor** is the relationship between the **Reference Unit** and the custom pressure unit. The **Reference Unit** may be any of the pre-entered pressure units available in MC6-WS.

Figure 119: Configuration page

When a user defined pressure unit is in use, the unit button displays a warning symbol (triangle with an exclamation point inside) together with the name of the user defined pressure unit. See an example in [Figure 120: User defined pressure unit in Calibrator](#) on how a user defined pressure unit is shown in **Calibrator**. Other MC6-WS's main functions display the user defined pressure unit similarly.

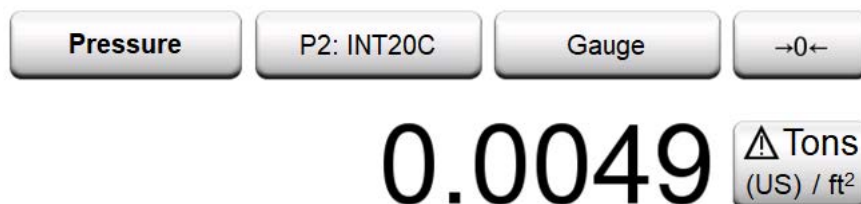

Figure 120: User defined pressure unit in Calibrator



Note: If you need to enter very small or big number into **Factor** field, open the menu available in **Soft Numeric Keypad**. When applicable, the menu contains a possibility to insert an exponent. This allows entering numbers in scientific notation, e.g. 5.775E-07.

User Defined PRT/RTD Sensors

General

Just as pressure units, MC6-WS has a wealth of pre-entered standard Platinum Resistance Temperature (PRT) type RTD sensors. They are available wherever you may select **RTD Temperature** as the **Quantity**. However, when using

a PRT sensor as a reference sensor, the available standard sensors aren't necessary of use. This is because reference sensors often have custom coefficients in, e.g. their **Callendar - van Dusen** equation.

Figure 121: 1st configuration page for defining custom sensors. Further pages, even the amount of them, depend on the selected Sensor Calculation Formula

After the pages with pre-entered PRT sensors, there is room for user defined PRT/RTD sensors.

When a user defined PRT/RTD sensor is in use, the sensor button displays a warning symbol (triangle with an exclamation point inside) together with the name of the user defined PRT/RTD sensor. See an example below on how a user defined PRT/RTD sensor is shown in **Calibrator**. Other MC6-WS's main functions display the user defined PRT sensors similarly.



Figure 122: User defined PRT sensor in Calibrator

When defining custom sensors, the **Sensor Calculation Formula** on the first configuration page is important. It affects what is available on further configuration pages. The following chapters present the use of different formulas.



Note: For further information about **Sensor Calculation Formulas**, refer to literature related to calibrating Platinum Resistance Temperature sensors.

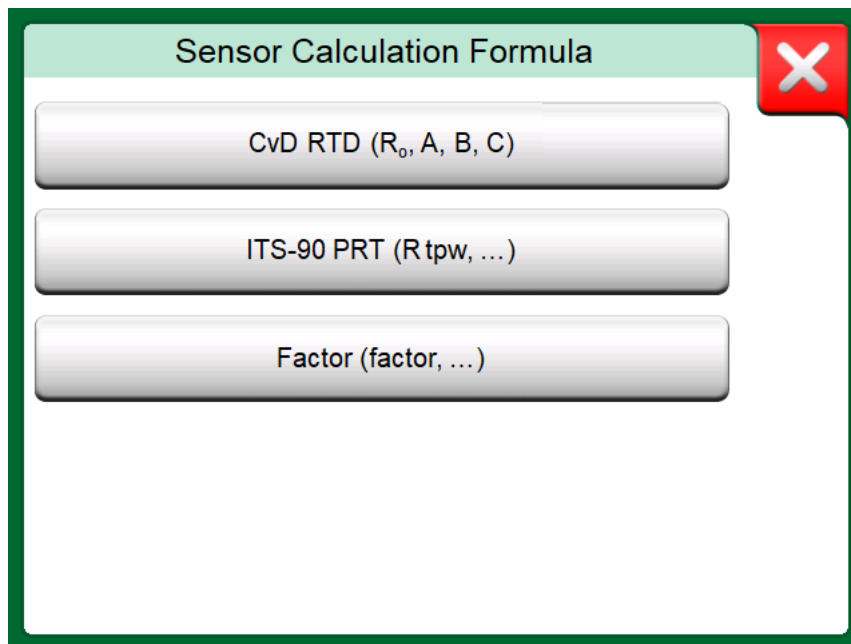

Figure 123: Sensor Calculation Formula options



Note: If you need to enter very small or big number into **Factor** field, open the menu available in **Soft Numeric Keypad**. When applicable, the menu contains a possibility to insert an exponent. This allows entering numbers in scientific notation, e.g. 5.775E-07.

Callendar van Dusen Formula for PRTs

When **CvD RTD (R_0 , A, B, C)**, i.e. Callendar van Dusen formula is selected, one additional configuration page is added.

Figure 124: Example of configuration page for Callendar van Dusen constant and coefficients

Callendar van Dusen formula for PRTs can be defined using one of two equations, each with their own coefficients: A, B and C or alpha, delta and beta (α , δ and β). Additionally, a constant, R_0 , is needed to define the sensor.

MC6-WS supports the use of the equation using coefficients A, B and C only. If your PRT's calibration certificate includes coefficients α , δ and β , use the following equations to convert them to A, B and C:

$$A = \alpha \cdot \left(1 + \frac{\delta}{100}\right) \quad B = \frac{-\alpha \cdot \delta}{10^4} \quad C_{T<0} = \frac{-\alpha \cdot \beta}{10^8}$$

Figure 125: Equations for converting coefficients.

ITS-90 PRT Sensor

If your calibration certificate includes coefficients for ITS-90 deviation function (International Temperature Scale of 1990) PRT sensor, select **ITS 90 PRT (R tpw,...)** as the **Sensor Calculation Formula**. Then you may enter the constant, R tpw, and one or more coefficients: a_x , b_x ..., where the subscript x is 4 to 11, depending on the deviation formula used in the calibration.

If the coefficients in your calibration certificate miss the subscripts, use the following table to find which coefficients you have been given.



Note: The definition of coefficient notations for the ITS-90 subranges is described in the NIST Technical Note 1265 "Guidelines For Realizing the International Temperature Scale of 1990".

Calibration ranges, corresponding coefficients and examples of calibration points:

<u>Calibration Ranges^(*)</u>	<u>Corresponding Coefficients</u>	<u>Example of fixed calibration points^(#), °C</u>			
Negative (sub-)ranges:					
-189 ... 0 °C	a₄, b₄	-189.3442,	-38.8344,	0.01	
-38 ... 30 °C	a₅, b₅^(†)	-38.8344,	0.01,	29.7666	
Positive (sub-)ranges:					
0 ... 30 °C	a₁₁	0.01,	29.7666		
-38 ... 30 °C	a₅, b₅^(*)	-38.8344,	0.01,	29.7666	
0 ... 157 °C	a₁₀	0.01,	29.7666,	156.5985	
0 ... 232 °C	a₉, b₉	0.01,	156.5985,	231.928	
0 ... 420 °C	a₈, b₈	0.01,	231.928,	419.527	
0 ... 660 °C	a₇, b₇, c₇	0.01,	231.928,	419.527,	660.323
0 ... 962 °C	a₆, b₆, c₆, d	0.01,	231.928,	419.527,	660.323, 961.78

†) subrange 5 is presented twice since it needs to be entered separately both for negative and positive sides.

*) the range limits in the adjacent list are rounded and shown as they are on MC6-WS User Interface.

#) Not all calibration laboratories necessarily use the same points. These are for reference only.



Note: If your calibration certificate include two sets of coefficients. One for zero current and another for 1 mA current, enter the latter ones into MC6-WS.

When selecting **ITS 90 PRT (R tpw,...)** as the **Sensor Calculation Formula**, the **Sensor Range** entered in the 1st configuration page defines how many additional **User Sensor** pages is added to MC6-WS. If the range includes temperatures below zero, there are four configuration pages:

1. First page for general settings. See [Figure 121: 1st configuration page for defining custom sensors](#). Further pages, even the amount of them, depend on the selected Sensor Calculation Formula.
2. Second page for entering the **R tpw** constant value.
3. Third page for selecting the deviation formula for **negative** temperature sub-range and entering the coefficients (a₄ and b₄ or a₅ and b₅).
4. Fourth page for selecting the deviation formula for **positive** temperature sub-range and entering the coefficients (a₅, a₆, a₇ ... etc.).

Figure 126: Examples of coefficients a_7 , b_7 and c_7

When no negative subrange is included in the calibration, the third page mentioned above is not included and the total amount of configuration pages is three.

Factor

The third way to customize an RTD sensor (not just PRTs but all types of RTDs) is using the **Factor**. This applies for sensors with the same relative error throughout the sensor's span, a sensor with an "offset" in its output.

How to Configure a User Sensor using Factor:

Select a standard **Sensor Type**. Then enter a **Factor** that offsets the standard temperature curve. A simple way of doing it is taking a standard RTD sensor with a 1 ohm resistance @ 0 °C, e.g. Pt1. Then enter the real resistance @ 0 °C as the **Factor**.

The screenshot shows a configuration window titled "User Sensor". At the top left is a home icon and a menu icon. The title bar contains "User Sensor" and a red close button with a white 'X'. Below the title bar, there are two input fields. The first is labeled "Factor" and contains the value "99.5". The second is labeled "Sensor Type" and contains the value "Pt1 α385". To the right of the input fields are three buttons: an up arrow button, a "2 / 2" indicator, and a down arrow button. At the bottom right corner, there is a green checkmark button.

Figure 127: Configuration page for Factor

Check Sensor Conversion

MC6-WS has a possibility to test sensors in the window presenting pre-entered and custom RTD sensors. The menu has an option: **Test Sensor Conversion**.

The [Figure 128: Sensor test configuration and single point test page](#) presents the first of the **Test Sensor Conversion** pages. It allows you to select a sensor, the unit to be used and a possibility to test a single point. This is handy when you have entered coefficients of a custom sensor and want to test if the coefficients were entered correctly. Enter, e.g. a temperature that is in the calibration certificate and check if the calculated resistance in MC6-WS is the same as on the calibration certificate. If yes, the entered coefficients in MC6-WS are correct. If not, check the coefficients you entered.

Check Sensor Conversion

Sensor Type: Unit:

Calculate (°C): ⇌ Calculate (Ω):

Table Step Size (°C):

Table Step Size (Ω):

1 / 3

Figure 128: Sensor test configuration and single point test page

The lower part of the first page allows you to define step sizes for tables seen on the second and third page. There you can see the sensor's temperature vs. resistance correlation (and vice versa) in table format.

User Defined Transfer Functions

Transfer Functions are available in Calibrator's **Scaling Tool** and in **Instrument Definitions** found in Documenting Calibrator.

When creating/selecting a user defined transfer function, tap on the **Transfer Function** button and browse to the **User Transfer Function** page.

The configuration consists of two (or more) pages as shown in [Figure 129: 1st configuration page](#) and [Figure 130: 2nd configuration page](#). The first page is for general definitions and the second for entering known transfer function points. If you enter more points than can be shown on one page, a further page is automatically added.

Figure 129: 1st configuration page

	Input (bar)	Output (mA)
1.	0.00000	4.00000
2.	1.00000	4.05000
3.	3.00000	4.78800
4.	5.00000	6.82000
5.	7.00000	11.0440
6.	Tap to Edit...	Tap to Edit...

Figure 130: 2nd configuration page

There are some "rules" on how to enter the transfer function points:

- The first point is always pre-entered and the values are not editable. They are the ranges' 0 % values.
- Manually entered points must be in increasing order.
- Last point must be exactly or greater than the range's 100 % value.

Also:

- The row number is a button. It opens a window where you may delete the current point or optionally add a row either before or after the current point.

- An added point gets default values: average values of preceding and following point.

User Defined Steps/Calibration Points

These are available for instruments in **Documenting Calibrator** and also in **Calibrator's Step** tool. Use either **Calibration Points** or **Step Definition** button to modify its setting. In the opened window, browse to **User Test Points** page.

The configuration consists of two (or more) pages as shown in the [Figure 131: 1st configuration page](#) and [Figure 132: 2nd configuration page](#). The first page is for general definitions and the second for entering steps/calibration points. If you enter more points than can be shown on one page, a further page is automatically added.

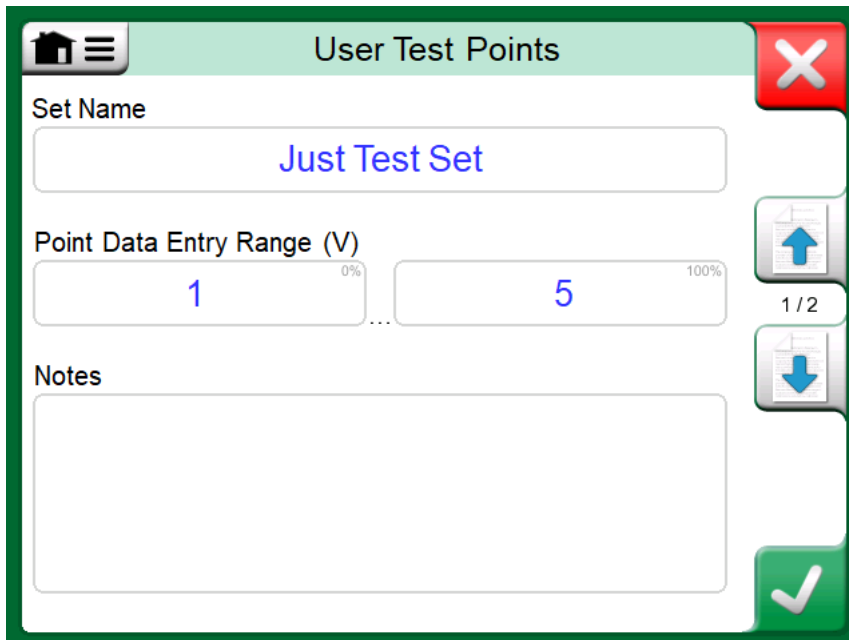

Figure 131: 1st configuration page

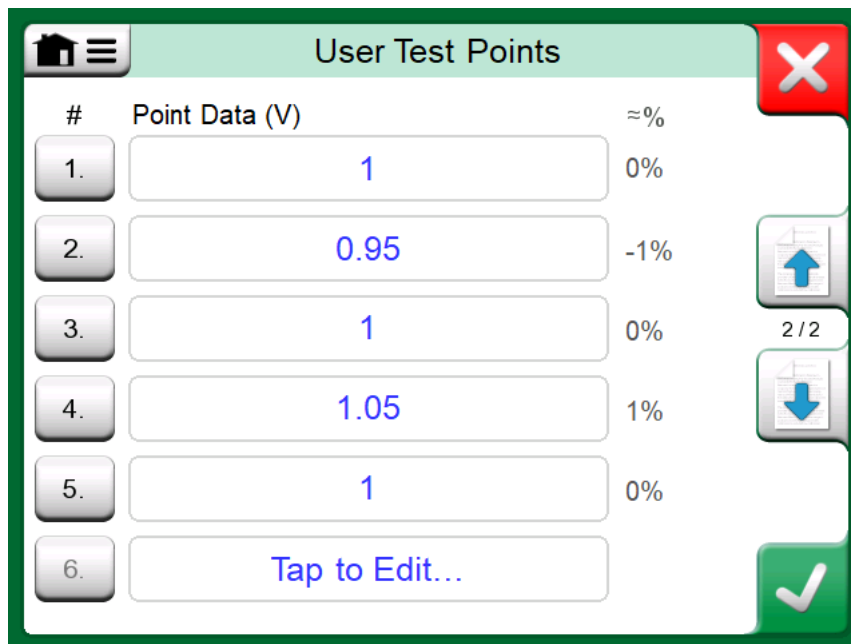

Figure 132: 2nd configuration page

There are no "rules" in what kind of values are entered. They may be outside given point data entry range and need not be in any strict order. See the picture above.

Also:

- The row number is a button. It opens a window where you may delete the current point or optionally add a row either before or after the current point.
- An added point gets a default value: Average value of preceding and following point.

Controller Communication

MC6-WS's communication with External Controllers (Pressure and Temperature) connected to the USB-A ports is optional. Check what options your MC6-WS has from the **Settings** window. Tap on the **About** button and browse to page with **Installed Options** information.

What Can be Done With Controller Communication

Ways of using an External Controller with MC6-WS:

- **Controller** (full use)

MC6-WS uses the External Controller to set and measure the signal. Controller can be taken into use in MC6-WS's Port/Function list in MC6-WS's **Calibrator**, **Documenting Calibrator** and **Data Logger**. See example in uppermost picture to the right. In **Beamex CMX Calibration Management Software**, this corresponds to **Input Method Controlled and Measured**.

- **Measurement (only)**

The External Controller acts like an external measuring device (comparable to an EXT External Pressure Module). This feature needs to be activated in MC6-WS's **Controller Presets** window. More of **Controller Presets** window further on. When activated, Measurement is available in Port/Function lists in MC6-WS's **Calibrator**, **Documenting Calibrator** and **Data Logger**. See [Figure 133: Pressure Port / Function list with Controller and Measurement available](#).

- **Control (only)**

MC6-WS uses the External Controller to set calibration points. It is measured by some other means, e.g. MC6-WS's Pressure Module. This is available in MC6-WS's Documenting Calibrator only. See [Figure 134: Instrument input settings with Control \(only\) selected](#). In CMX, this corresponds to Input Method Controlled.

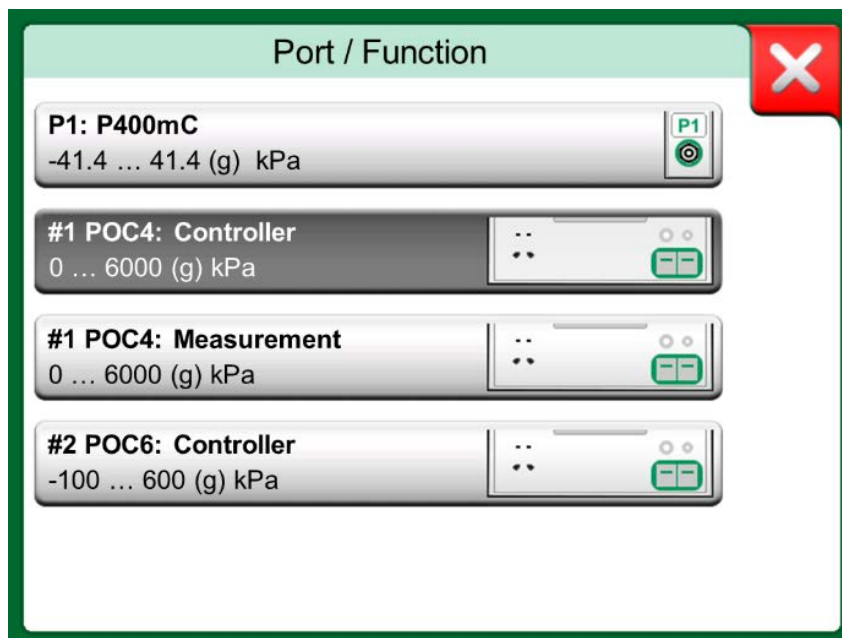

Figure 133: Pressure Port / Function list with Controller and Measurement available



Note: If a Pressure Controller is internally connected to MC6-WS, the USB port in MC6-WS's front panel is not needed

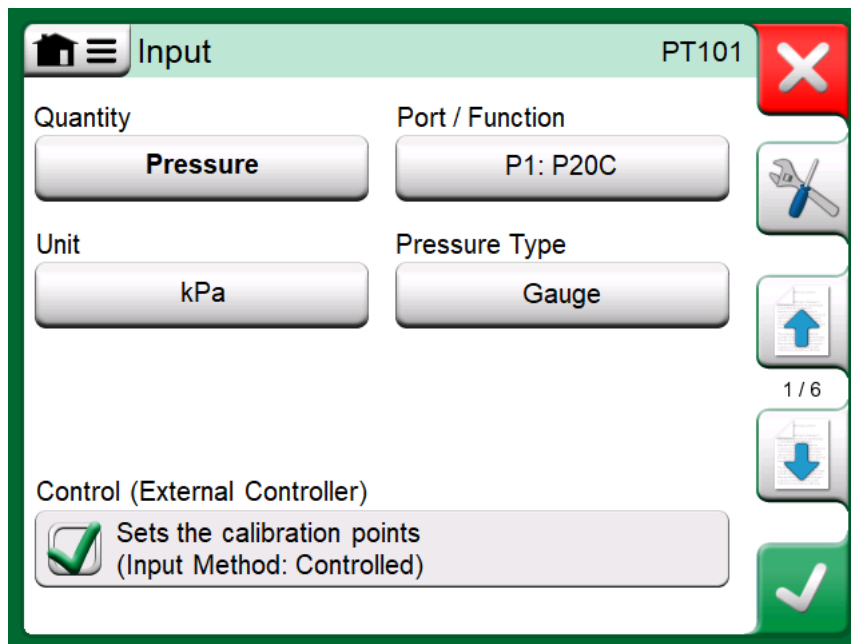

Figure 134: Instrument input settings with Control (only) selected



Note: When connecting a Beamex FB or MB Temperature Dry Block to MC6-WS, ensure that both devices are up and running before connecting a communication cable and invoking communication between them.

Configuring Controller Communication

Before utilizing External Controllers, both the communication cable/driver and the controller itself need to be configured in MC6-WS. We recommend this to be done using the **Controller Preset** window available in MC6-WS's main function **Settings**. MC6-WS supports up to four presets. Each of the presets create a pair of a **Connection Interface** (communication cable/driver) and a **Controller Type**. See [Figure 135: Example of a Controller Preset](#).

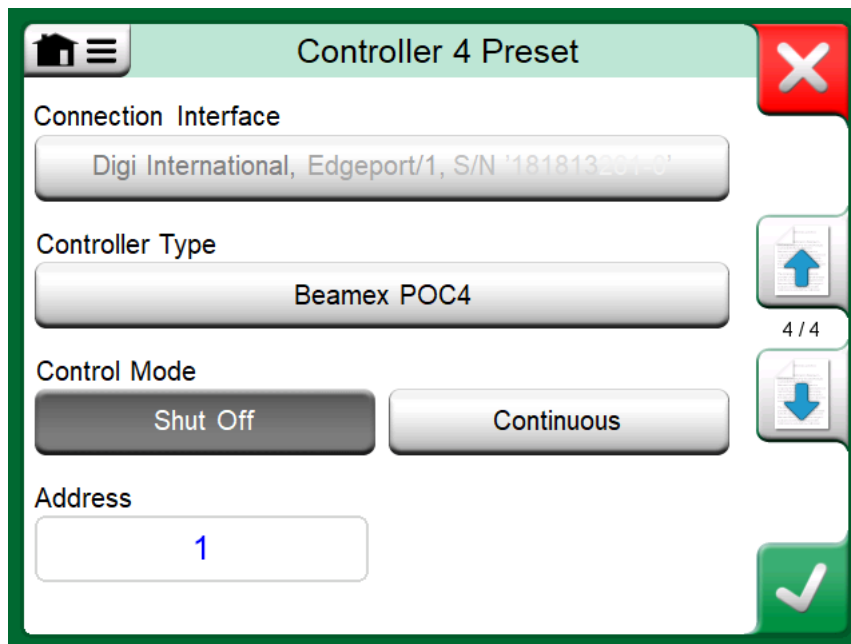

Figure 135: Example of a Controller Preset

The menu in a **Controller Preset** window contains further tools for defining the communication. One of the menu items is **Enable Measurement Port**, defining if the is controller also used as a measuring device. Menu selections may be individual for each preset.

When an External Controller is connected and configured, it is available as any port in MC6-WS's user interface.



Note: If you run into communication problems, check the communication settings of the connected controller. They may have been changed from the controller's default values. MC6-WS always uses the controller's default values.

The Controller Preset window's menu includes an option to view the **Communication Log**. In the Communication Log window you may choose the log format: binary or textual.

Changing Controller During Calibration

In Documenting Calibrator, you may need to change the controller during calibration. This, e.g. because a temperature controller's span is not useful throughout the measurement span of the instrument to be calibrated.

Change the controller as follows:

1. During calibration, open the **Documenting Calibrator's** Menu.
2. Select option **Instrument Input**.
3. In the **Instrument Input** window, tap on the button that invokes the controller change procedure.
4. Follow the instruction on the screen.

Appendix

Things discussed in this part:

- Safety Issues and Warnings
- Disposal of Waste Electrical and Electronic Equipment
- Servicing MC6-WS
- Statements and Warranty
- Index

Safety



Pressure modules with a measuring range of 6 bar (90 psi) or less are overpressure protected. If the measurement pressure of a pressure module exceeds the module's maximum pressure value, the overpressure protector vents excess pressure through a hole in the rear of the case.

Approvals

Safety	Directive 2014/35/Eu, EN 61010-1:2010
EMC	Directive 2014/30/Eu, EN 61326-1:2013

Symbols Used

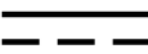
The following symbols concerning electrical safety are used in MC6-WS.

	Alternating current, AC
	Direct current, DC
	Caution! See manual for further information

Safety Precautions and Warnings

MC6-WS is a precision tool that should be used by skilled people who have read and understood this manual. Working with MC6-WS involves the usage of pressure and/or electrical instruments. Be sure to know how to work with these instruments and how to safely connect/disconnect pressure hoses as well as electrical test leads clips, etc.

Sometimes it is necessary to use a portable radio transceiver while working with the calibrator. To prevent calibration errors caused by the radio frequency interference, keep the radio far (at least 1 meter) from the calibrator and the circuit under calibration while sending.

Use MC6-WS only if you are certain of that it can be used safely. Safe use of MC6-WS is no longer possible if one or more of the following cases are true:

- When the case of MC6-WS is evidently damaged
- When MC6-WS is not functioning as expected
- After prolonged storage in unfavorable conditions
- After serious damage during transport

Operating Conditions

Temperature	-10 ... 45 °C (14 ... 113 °F)
Humidity	0 to 80 % R.H. non condensing
Max. altitude	3000 m (approx. 9,800 ft)

General Warnings



Warning: Do not use MC6-WS in any other way than as described in this User Manual. If this equipment is used in a manner not specified by the manufacturer, the protection provided by it against hazards may be impaired.



Warning: Do not tap the touch screen with sharp or hard objects or press hard on the display, especially with fingernails. Instead, tap lightly using your fingertips.

Warnings Concerning the Lithium Polymer Battery Pack



Warning: Lithium-Polymer (LiPo) batteries require very careful handling. To prevent accidents or damage to persons or property, follow all safety precautions and warnings presented here.

Always use battery pack delivered by Beamex. Use of battery packs not meant for MC6-WS is dangerous. When replacing a battery make sure the polarity is correct. Never short circuit the battery pack. Not observing these warnings may result in an explosion.

Do not leave the battery pack in a car on a hot day, in direct sunlight or close to any heat source. Heat causes loss of performance and the battery pack may even ignite and explode. See chapter [Operating Conditions](#) as well as chapter [Charging the Lithium Polymer Battery Pack](#).

Do not use the battery pack, if in any situation, the battery emits an unusual smell, heats up, is deformed or is otherwise behaving unusually. Remove and check the condition and behavior of the battery pack especially after MC6-WS has for some reason been knocked or dropped.

Never disassemble the battery pack. The battery pack contains safety and protection electronics. If the electronic is damaged, it may cause the battery to warm up, or even ignite and explode.

If the battery pack leaks and fluid comes in contact with your skin, carefully wash with soap and water. If fluid gets in your eyes, flush with plenty of cold water and seek immediate medical care.

Never extinguish a Lithium Polymer fire with water. Do not expose battery to water or salt water, or allow the battery to get wet.

Disposal/Replacement of Battery Pack



Warning: First you must discharge the battery pack, using MC6-WS normally. Then remove battery pack as described in chapter [Removing/Replacing the MC6-WS Battery Pack](#). To avoid short circuiting the terminals, insulate them with adhesive tape. Finally, place battery pack in a fire proof container and dispose according to local regulations.

Do not transport the Battery Pack to be disposed as cargo or freight.

Replace the Battery Pack with a new one bought directly from Beamex or from a Beamex representative. Contact information is on the prepages of this manual.

Do not replace the Battery Pack with any other Battery Pack type than the one available from Beamex/representative! Using other type of Battery Packs may render MC6-WS unsafe – fire or explosion may occur. Also: Use of other Battery Packs voids the warranty.

Charging the Lithium Polymer Battery Pack

**Warning:**

Charge the battery pack using only the charger provided with MC6-WS (inside CENTRiCAL Instrument Panel). MC6-WS should never be left unattended while charging.

The charger operates in the following environments:

Voltage: 100 ... 240 VAC

Frequency: 50/60 Hz

Indoor use only, IP 40.

Charge within the following temperature range:

0 °C to 40 °C (32 °F to 104 °F).

Charge MC6-WS away from flammable items or liquids.

Use the charger in environments containing limited amounts of dust and humidity, e.g. in a laboratory or an office.

If the battery pack starts to heat up or deform, stop charging process immediately and disconnect the charger. Place MC6-WS in a fire proof location and wait for approx. 15 minutes. If no problems occur, try charging again, but be extra careful and oversee how the charging progresses. It is better to replace a faulty battery pack than risk serious damages.

Do not continue charging the battery, if it does not recharge within the specified charging time. Charging time is approximately 4 hours (for 4400 mAh battery pack).

After extended periods of storage, it may be necessary to charge and discharge the cells or batteries several times to obtain maximum performance.

Storing



Warning: When transporting or temporarily storing MC6-WS's battery pack, store it in 30/40 % charged state. Storing in a fully charged or discharged state results in substantial capacity loss, or malfunction of the protection electronics.

Recommended storing temperature for the battery pack is between -20 °C to 45 °C (-4 °F to 113 °F). The lower the temperature (but well above freezing point) the better for keeping up the capacity.



Note: When MC6-WS is not used for a longer period, charge MC6-WS in 3 month periods.

Warnings Concerning Electrical Measurement and Generation



Warning: MC6-WS's OUT section terminals are protected against over voltage and over current as far as it has been possible without affecting the accuracy. Do not however connect signals that are above the measurement range of the selected Function.

Maximum output voltage from MC6-WS's terminals is below 30 V. If you, however, connect together voltages from the IN and OUT sections or if you connect external voltages to MC6-WS, the resulting voltage may be high enough to be hazardous.

There is no galvanic isolation between the connectors in the IN section or the pressure module connectors connected to CENTRiCAL Instrument Panel.

However there is a galvanic isolation between MC6-WS's IN and OUT sections, it is for functional purposes only. Do not exceed 60 VDC / 30 VAC / 100 mA between any terminals.

Functional insulation is not intended for protection against transient overvoltages. Do not connect measuring terminals to circuits where transient overvoltages are possible.

General Warnings Concerning Pressure Measurement



Warning: The maximum pressures of available optional pressure T-hoses:

- 20 bar at 21°C (290 psi at 70°F).
- 40 bar at 21°C (580 psi at 70°F).

Applying higher pressure than the maximum pressure can be hazardous.

We recommend the use of the optional pressure hose sets. When using other hoses and connectors, make sure they are high quality products that withstand the used pressure.



Warning: To avoid damaging the calibrator, use hand tightening only (max. torque 5 Nm) when connecting the pressure measurement hose to the internal pressure module. If the use of tools is required to secure the connection (typically an internal pressure module with a pressure range of 20 bar / 300 psi), apply the counterforce with a spanner on the connector body's hexagonal part.

Always depressurize the system before opening or connecting any pressure fittings or connectors. Use proper valves for venting the system. Ensure that all connections are made correctly and that the hose and the connectors are intact.

The allowed pressure media for internal pressure modules is inert, non-toxic, non-explosive media. External modules have the allowed media printed on the module's sticker. Using unsuitable pressure media may destroy the pressure module/calibrator.



Warning: External Pressure Modules: Use only the pressure media stated on the pressure module. Use of wrong type of Pressure Media may destroy the pressure module.

Never exceed the maximum pressure of a pressure module. The internal pressure module's maximum pressure is stated on calibrator's sticker. The maximum pressure of external modules is stated on module's sticker and mentioned in the Instruction Booklet that is provided with the external module.

Never plug a hose with your hands or put hands in front of a gas spray coming from a leakage. A gas bubble in the blood circulation can cause death.

Warnings Concerning High Pressure



Warning: High pressure is always dangerous. Only personnel with good experience and knowledge of high pressure liquid, air and nitrogen operations are allowed to work with the module. Read carefully all these instructions and familiarize yourself with local safety instructions for high pressure operations before starting the use.

When using gas, the system must not contain any liquid, especially if you do not know how they may react under pressure. Use of clean air or nitrogen is recommended as gaseous pressure media. Liquid pressure media should be preferred when using modules with a pressure range of 60 bar (30000 psi) or more.



Warning: If you use nitrogen, minimize the leak to the atmosphere and take care of sufficient ventilation. Close the valve of the nitrogen cylinder, when the system is not in use. Increase in the percentage of nitrogen in the ambient air may cause unconsciousness and death without warning. Read carefully the safety instructions for nitrogen and make sure that the other people in the same space are aware of the danger.

Use of liquid pressure medium is recommended with pressure measurement modules at higher pressure range. Use water or suitable hydraulic oil. Check that the used liquid is not aggressive against the materials used in the transducer or tubing. When using liquid, minimize the amount of air in the system. So you can minimize the amount of spilled liquid in case of leakage.



Warning: Do not use the same tubing with different liquids or gases.

Check what the local regulations say about construction and use of pressurized vessels. The regulations normally control construction and use of systems where the product of the pressure and volume exceeds a certain limit. The volume of this system depends on the instrument connected to it.

High pressure gas is dangerous because it can break the container and the flying splinters may cause injury. Also small leaks of gas may be dangerous because the high velocity of the leaking gas jet enables penetration through skin. If a gas bubble gets into the blood circulation, it can cause death. The leak jet is particularly penetrative, if some liquid is coming with the gas.

Disposal of Waste Electrical and Electronic Equipment

Beamex and WEEE

Beamex is an environmentally conscious company developing products with a view to ensure that they are easy to recycle and do not introduce hazardous materials into the environment.

In the European Union (EU) and other countries with separate collection systems, waste from electrical and electronic equipment (WEEE) is subject to regulations.

EU WEEE Directive 2012/19/EU (the WEEE Directive) requires that producers of electronic equipment are responsible for the collection, reuse, recycling and treatment of WEEE which the Producer places on the EU market after August 13, 2005. The objective of this regulation is to preserve, protect and improve the quality of the environment, protect human health, and conserve natural resources.



The symbol above is engraved on the product's back side. It indicates that this product should be handed over to applicable collection point for the recycling of electrical and electronic equipment.

For more detailed information about recycling of this product, please contact your local representative or your waste disposal service.

Disposal of Battery Pack

MC6-WS contains a Lithium Polymer (LiPo) battery pack.

Before disposing of MC6-WS, discharge the battery pack, then remove it from MC6-WS (see chapter [Removing/Replacing the MC6-WS Battery Pack](#)).

Service

Cleaning MC6-WS

If MC6-WS needs cleaning, use a cloth soaked with a mild solution of tall oil soap (pine soap) or with a common liquid dish soap. Wait a few minutes and then clean using a cloth moistened with pure water. Never use any strong detergents.



Note: To clean the display, use a microfiber cloth. If necessary, use a mild detergent and remove it thoroughly when ready.



Caution: Isopropanol based cleaning spray is not recommended for cleaning the MC6-WS devices (may damage surfaces). It can however be used to clean the pressure connectors.

The Battery Charger

MC6-WS's battery charger is inside CENTRiCAL Instrument Panel. The charger is not intended to be serviced. When unusable it can be thrown away according to local waste disposal regulations.

Sending MC6-WS for Service

When sending MC6-WS for service, follow regulations related to transporting devices containing Lithium Polymer Batteries.

Read also chapter [Warnings Concerning the Lithium Polymer Battery Pack](#).

For further information, contact Beamex. Contact information is on the prepages of this manual.



Note: When sending MC6-WS for service to Beamex, there is no need to include the charger. See also chapter [Uninstalling/installing Modules to/from CENTRiCAL](#)

Firmware Update

The quickest way to see if a new firmware version is available is checking out Beamex's website (<https://www.beamex.com>). Go to the "Downloads" page and see what it says about MC6-WS firmware versions and downloads.

Transfer the update software to a USB Stick (USB Flash Memory). Connect the USB stick to one of MC6-WS's USB-A ports.

Starting the Firmware update

With one hand: Press and hold down the **Left Arrow** and **Right Arrow** keys in MC6-WS. With the other hand: Press and hold down the **Home** and **Enter** keys in MC6-WS. Hold the keys down until MC6-WS restarts. This should take approx. 8 seconds. Release the **Home** and **Enter** keys but keep the **Left Arrow** and **Right Arrow** keys pressed until the update mode screen is shown. If the calibrator starts normally, then something went wrong and you should restart the firmware update procedure.

Follow the instructions seen on MC6-WS's screen. The update is a multi-phase process, so be patient. Also check for possible release notes accompanying the update file.

The quickest way to see if a new firmware version is available is checking out Beamex's web site (<https://www.beamex.com>). Look for **Downloads Center** and see what it says about MC6-WS firmware versions and downloads. Also check for possible release notes accompanying the update file.

Transfer the update software to a USB Stick (USB Flash Memory). Make sure MC6-WS is **powered off**. Connect the USB stick to one of MC6-WS's USB-A ports.

Press and hold the **Left** and **Right** hardware arrow button and push the **On/Off** button. The update starts automatically. Follow the instructions seen on MC6-WS's screen. The update is a multiphase process, so be patient.



Note: Updating MC6-WS firmware does not erase any user entered data (instruments, calibration results, data logs etc.).

Supported file systems on USB Flash Memories are FAT 32 and FAT 16.

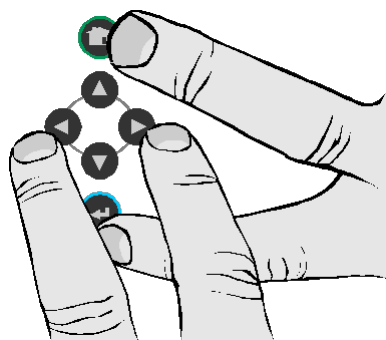

Resetting MC6-WS

Sometimes you may want to reset/restart the calibrator. To do that, press and hold the Home and Enter keys for 7 seconds.



Note: Resetting MC6-WS affects its internal clock. Remember to check the date and time after reset and correct them when needed. None of the saved data is affected. Possible open files may however be lost.

Recalibrating MC6-WS

As any test and measurement device, we recommend to recalibrate MC6-WS at regular intervals. This ensures accuracy and operating reliability throughout MC6-WS's lifetime.

MC6-WS is a high-accuracy calibrator and it should be recalibrated only at laboratories being able to offer sufficient uncertainty. Please note that all calibration laboratories are not able to offer required uncertainty. It is highly recommended that the calibration laboratory is accredited (ISO 17025) and has certified quality system in place.

For information on how to uninstall MC6-WS or Pressure Modules, see chapter [Uninstalling/installing Modules to/from CENTRiCAL](#) for further advice, please contact Beamex.

By sending the calibrator to Beamex or your closest Beamex authorized service center for recalibration, you can be sure that your equipment will be cleaned, fully tested, loaded with the latest firmware/features, and recalibrated in a state-of-the-art calibration facility that meets the specifications of the calibrator.



Note: When setting MC6-WS's calibration date, see [Part 8, Settings](#).

During the calibration procedure, it is recommended to disconnect the charger to avoid possible disturbances. Also: Ensure MC6-WS's batteries are fully charged.

If you are recalibrating MC6-WS on site, as it is installed in CENTRiCAL, please ensure that MC6-WS and CENTRiCAL are grounded.

If you send MC6-WS for recalibration to Beamex, there is no need to include the charger in the delivery. It is not worth the trouble.

If you send MC6-WS for recalibration to another calibration laboratory, send a portable MC6 Calibrator's charger with the module, if possible.

Uninstalling/installing Modules to/from CENTRiCAL

User Manual - CENTRiCAL Workstation, Assembly Instructions contains instruction how to install or uninstall modules to/from CENTRiCAL.



Note: If you install MC6-WS to CENTRiCAL Instrument Panel yourself, ensure that both MC6-WS and all its pressure modules are properly grounded.

MC6-WS's Battery Pack And Charger

MC6-WS has a battery pack allowing the use of MC6-WS even when CENTRiCAL is shut down. The battery pack's main task is keeping the internal clock/calendar in time when CENTRiCAL is shut down.

The battery pack's charger is situated inside CENTRiCAL Instrument Panel. When the batteries are charged, the battery symbol and a plug symbol alternate on the status bar. When the battery pack is full, only the plug symbol is shown.

If MC6-WS is shut off and CENTRiCAL bench is still on, a battery symbol appears. After a while, an estimate of the remaining charge time appears below the battery symbol.



Warning: USE THE CHARGER PROVIDED WITH THE CALIBRATOR ONLY. FURTHER WARNINGS PRESENTED IN CHAPTERS [Warnings Concerning the Lithium Polymer Battery Pack](#) and [Charging the Lithium Polymer Battery Pack](#), both in [Appendix](#).

Removing/Replacing the MC6-WS Battery Pack

With time the capacity of the Lithium Polymer batteries deteriorates and MC6-WS loses its time and date. To remove or replacing the batteries, do as follows:

- 1. Important!** Make sure both CENTRiCAL and MC6-WS are shut off. Disconnect the mains cables from the wall outlet. Unscrew the screws that holds the module in the Instrument Panel (located in the corners of the front panel). Uninstall the module from Instrument Panel and disconnect any possible connections between the MC6-WS and the Instrument Panel to be disconnected.
- 2.** Remove MC6-WS's cover using a Torx 20 screwdriver.
- 3.** The battery pack is located at the rear of MC6-WS. See the picture below.
- 4.** Unplug the battery pack's connection cable and pull out the battery pack.
- 5.** Push the new battery pack into the slot and plug the connection cable to the circuit board.

6. Start CENTRiCAL and MC6-WS. Check that MC6-WS is working as it should.

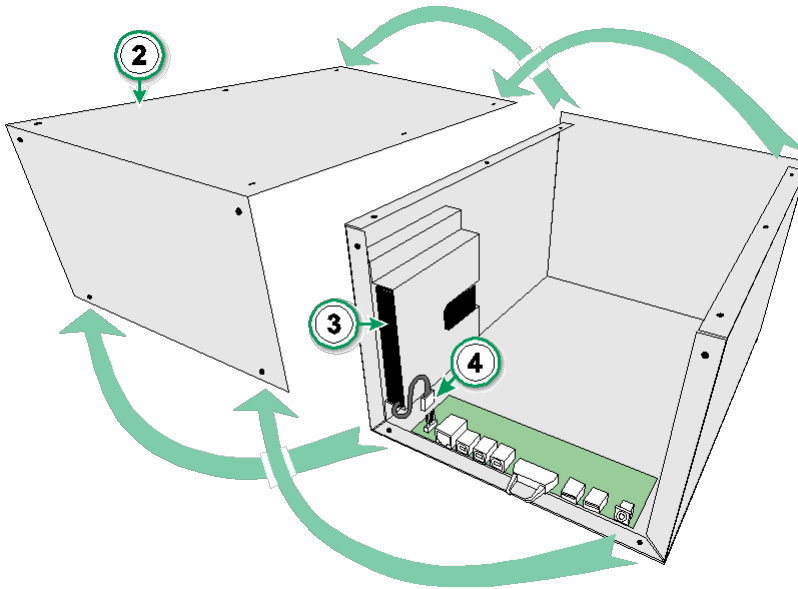

Figure 136: Removing/replacing the batteries

"Teach" MC6-WS the capacity of the new battery pack by following steps below:

1. MC6-WS should be running on the battery pack. Make sure the device is powered on and Main switch is switched off.
2. Go to **Settings > Power Management** and set the **Calibrator Auto-off Delay** value to 0.
3. Wait until unit powers down due to empty battery pack.
4. Charge the battery pack by switching the Main switch on.
5. Let the battery pack fully charge (100% on the display).



Warning: Read the warnings presented in chapter *Warnings Concerning the Lithium Polymer Battery Pack* in Appendix.

Index

A

About this manual.....	7
Accessories.....	22
Additional Info.....	43
Additional Information.....	103
Alarms.....	43
Approvals.....	119
Auto-Off Settings.....	100

B

Backlight.....	9
Batteries.....	
Charging.....	122
Disposing.....	121
Removing/Replacing.....	130
Storing.....	123
Buttons.....	
Accept.....	10
Check Boxes.....	10
Close.....	10
Hardware Focus Indicator.....	10
Home.....	9
Menu.....	10
Power.....	9

C

Calibration.....	
Changing the Pressure Module.....	58
Customizing Mapping.....	68
Deleting Results.....	66
Group Calibration.....	60, 63
Instrument Overview.....	53
Mapping Instrument Data.....	66
Saving Results.....	54
Selecting a Fieldbus Parameter.....	88
Selecting a HART Parameter.....	87
Viewing Results.....	65
Calibration Software.....	19, 22, 48
Calibrator.....	42
Changing Controller During Calibration.....	118
Charger.....	127
Charging the Battery Pack.....	122
Check Boxes.....	10
Cleaning MC6-WS.....	127
Communication Settings.....	100
Communicator.....	
Connections.....	83
Editing a Parameter.....	88
List of Instruments.....	84
Selecting a Variable.....	86
Selecting the Instrument.....	84

Trimming a Fieldbus Instrument.....	89
Trimming a HART Instrument.....	91
Configurations (Smart Transmitters).....	
Managing.....	97
Saving.....	96
Viewing.....	97
Configuring Pressure Controllers.....	117
Configuring Temperature Controllers.....	117
Connections.....	
Fieldbus/HART.....	83
General.....	23
Thermocouple.....	38
Connectors.....	
Front side.....	14
Right side.....	14
Controller Communication.....	
Changing Controller.....	118
Configuring.....	117
Controller Settings.....	100
Current Generation.....	33
Current Measurement.....	25
Customizing Mapping Instrument Data.....	68

D

Damping.....	43
Data Logger.....	
Configuring.....	73
Deleting Results.....	76
Saving Configurations.....	74
Saving Results.....	76
Selecting a Fieldbus Parameter.....	88
Selecting a HART Parameter.....	87
Starting.....	75
Transferring Results to a PC.....	78
Viewing Results.....	76
Date & Time Format.....	100
Date/Time Fields.....	10
Display.....	18
Disposing MC6-WS.....	126
Documenting Calibrator.....	47
Documenting Calibrator, Inheriting Settings.....	23

E

Editable Fields.....	
Date/Time.....	10
Numeric.....	10
Text.....	10
EMC Approval.....	119
Entering Numbers.....	31, 32
External Controllers.....	117
External Pressure Modules.....	24
External Reference Junction.....	38

F

Factory Hierarchy.....	49, 51
Fieldbus Instruments.....	58, 80
Fieldbus Settings.....	100
Firmware.....	10
Firmware Update.....	128
Fixed Reference Junction (Temperature).....	38
FOUNDATION Fieldbus™.....	80
Frequency Measurement.....	29
Front Panel Connections.....	16
Front Side Connectors.....	14
Function Info.....	43

G

Generation (see also Simulation).....	
Changing the generated value.....	31
Current.....	33
Frequency.....	37
Pulses.....	37
Voltage.....	34
Group Calibration.....	
Collecting Instruments.....	60
Editing a Group.....	62
Settings.....	63

H

Hand Pumps.....	22
Hardware Focus Indicator.....	10
HART Settings.....	100
HART®.....	58, 80
Headers, described.....	7
Home button.....	9
Home View.....	9

I

Ingress Protection Approval.....	119
Inheriting Settings.....	23
Instrument.....	50
Instrument List.....	49
Internal Reference Junction.....	38

L

Language.....	100
Leak Test.....	43
Lithium Polymer Battery Pack.....	121
Loop supply.....	25

M

Maintenance.....	100
------------------	-----

Managing Smart Transmitter Configurations....	97
Manual Reference Junction (Temperature).....	38
Mapping Instrument Data.....	66
MC6 Fieldbus Configuration Viewer.....	98
MC6-WS.....	
Approvals.....	119
Charger.....	127
Cleaning.....	127
Firmware.....	10
Hardware.....	14
Recalibrating.....	129
Resetting.....	129
Safety.....	119
Servicing.....	127
Starting.....	9
Warnings.....	119
Measurement.....	
Calibrator.....	42
Current.....	25
Frequency.....	29
Meter.....	40
Pressure.....	24
Pulse Counting.....	29
Resistance.....	27, 28
RTD.....	27
Switch Sensing.....	30
Thermocouple.....	27
Voltage.....	26
Memory.....	18
Menu Button.....	10
Meter.....	40
Mobile Security Plus.....	101

N

Numbers, Entering.....	31, 32
Numeric Fields.....	10
Numeric keypad.....	31

O

Options.....	
Security Tool.....	101
Software.....	20

P

PC Communication.....	19, 22, 48
Plant Structure.....	49, 51
Power Management.....	9, 100
Pressure Controllers.....	22, 115
Pressure Measurement.....	
External Pressure Modules.....	24
Zeroing a Pressure Module.....	25
PROFIBUS PA™.....	80
PRT Sensors.....	
Callendar van Dusen.....	107

Factor customization.....	110
ISO 90.....	108
Testing Custom Sensors.....	111
User Defined.....	105
Pulse Counting.....	29
Pulse Generation.....	37

Q

Quick Access Buttons.....	43
---------------------------	----

R

Ramping.....	43
Recalibrating MC6-WS.....	129
Reference Junction.....	27
Reference Junction Connections.....	38
Regional Settings.....	100
Resetting MC6-WS.....	129
Resistance Measurement.....	28
Resistance Simulation.....	36
Resolution.....	43
Results (Calibration).....	
Deleting.....	66
Saving.....	54
Viewing.....	65
Right Side Connectors.....	14
RTD Measurement.....	27
RTD Simulation.....	35

S

Safety.....	119
Saving Smart Transmitter Configurations.....	96
Scaling.....	43
Security Plus.....	101
Security Tool.....	101
Servicing MC6-WS.....	127
Settings.....	100
Simulation (see also Generation).....	
Changing the simulated value.....	31
Resistance.....	36
RTD.....	35
Thermocouple.....	34
Software Options.....	20
Sounds.....	100
Spinner.....	32
Stability Test.....	43
Standard Accessories.....	8
Standby Mode.....	9
Starting a Data Log.....	75
Starting MC6-WS.....	9
Stepping.....	43
Storing the Battery Pack.....	123
Supply Voltage.....	25
Switch Sensing.....	30
Symbols, Alarms.....	43

T

Temperature Blocks.....	22
Temperature Controllers.....	115
Testing Leakage/Stability.....	43
Text Fields.....	10
Thermocouple Connections.....	38
Thermocouple Simulation.....	34
Tools.....	
Additional Info.....	43
Alarms.....	43
Damping.....	43
Function Info.....	43
Leak/Stability Test.....	43
Quick Access Buttons.....	43
Ramping.....	43
Resolution.....	43
Scaling.....	43
Stepping.....	43
Touch Screen Display.....	18
Trimming a Fieldbus Instrument.....	89
Transferring Data Log Results to a PC.....	78
Trimming a HART Instrument.....	91
Typographical conventions.....	8

U

Unpacking.....	8
Updating 's Firmware.....	128
User Defined Calibration Points.....	114
User Defined Pressure Units.....	104
User Defined PRT Sensors.....	105
User Defined Steps.....	114
User Defined Transfer Functions.....	112

V

Viewing Smart Transmitter Configurations.....	97
Voltage Generation.....	34
Voltage Measurement.....	26
Volume of Sounds.....	100

W

Warnings.....	
Charging the Battery Pack.....	122
Electrical.....	123
General.....	120
Lithium Polymer Battery Pack.....	121
Pressure Measurement.....	124, 125
Use of Communicator.....	82
WEEE.....	126

Z

Zeroing a Pressure Module.....	25
--------------------------------	----